



VERZEICHNIS DER ORIENTALISCHEN HANDSCHRIFTEN
IN DEUTSCHLAND • SUPPLEMENTBAND 26,11

VERZEICHNIS DER ORIENTALISCHEN HANDSCHRIFTEN
IN DEUTSCHLAND

IM EINVERNEHMEN MIT DER
DEUTSCHEN MORGENLÄNDISCHEN GESELLSCHAFT
HERAUSGEGEBEN VON
WOLFGANG VOIGT

SUPPLEMENTBAND 26,11

FRANZ STEINER VERLAG GMBH WIESBADEN

1982

NAC HITEXTEDITION

TEIL 11

97,aal-97,y

VON

KLAUS LUDWIG JANERT

UND

ILSE PLIESTER



FRANZ STEINER VERLAG GMBH • WIESBADEN

1982

Titelvignette: Ilse Pliester

ZG 53H[^]- ÖLS
Supp>t,

44

CIP-Kurztitelaufnahme der Deutschen Bibliothek

Nachitextedition / von Klaus Ludwig Janert u. Ilse Pliester. - Wiesbaden: Steiner
(Verzeichnis der orientalischen Handschriften in Deutschland; Suppl.-Bd. 26)
NE: Janert, Klaus L. [Hrsg.]; GT
Teil 11. 97,aal - 97,y. - 1982.
ISBN 3-515-03500-1

Alle Rechte vorbehalten

Ohne ausdrückliche Genehmigung des Verlages ist es auch nicht gestattet, das Werk oder einzelne Teile daraus nachzudrucken oder auf photomechanischem Wege (Photokopie, Mikrokopie usw.) zu vervielfältigen. Gedruckt mit Unterstützung der Deutschen Forschungsgemeinschaft. © 1982 by Franz Steiner Verlag GmbH, Wiesbaden.

Druck: Rhein Hessische Druckwerkstätte Alzey. Einband: Buchbinderei Hiort, Wiesbaden.

Printed in Germany

VORWORT

Die Manuskripte stammen aus der Lichiang-Region von Yünnan im Südwesten Chinas, wo die Nachiminorität heimisch ist. Sie wurden dort von J. F. Rock als seine Privatsammlung zusammengetragen, später seitens der Westberliner „Staatsbibliothek Preußischer Kulturbesitz“ durch W. Voigt von G. Tucci oder J. F. Rock erworben und beschrieben in dem Katalogwerk: K. L. Janert, *Nachihandschriften*, Teil 3-5, 1975-80 (Verzeichnis der orientalischen Handschriften in Deutschland, Band 7,3-5).

Der vorliegende Teil 11 der *Nachitextedition* (Verz. der or. Handschr. in Dtschld., Supplementband 26,11) folgt nach Inhalt und Aufbau genau dem genannten Katalogwerk (3: Hs.or.sim.; 4: Hs.Or. und K.Or.; 5: Restliches), dessen Handschriftenreihenfolge, Inhaltsverzeichnis, Register und Vorwörter deshalb auch hier gelten: *Nachitextedition* und *Katalog* bilden also eine Einheit und gehören untrennbar zusammen, wobei in diesem Nachitexteditionsteil 11 folgende Manuskriptpartien des Katalogwerks herausgegeben werden:

Katalog der Nachihandschriften, Teil 3, Seite 693-700,
Katalog der Nachihandschriften, Teil 4, Seite 1081-1090,
Katalog der Nachihandschriften, Teil 5, Seite 1204.

Wir bitten um Nachsicht wegen einiger Corrigenda: Seite 23 oben: 8193 A (nicht 8193 B), S. 138 oben: 8204 A (nicht 8204), S. 302 unten: 5119 (nicht 5113).

Wir danken allen den Damen und Herren, die unsere von der Deutschen Forschungsgemeinschaft getragene und sich über viele Jahre erstreckende entsagungsvolle Arbeit, die verantwortungsbewußte wissenschaftliche Ausarbeitung der allerersten systematisch angelegten Nachitextedition überhaupt ermöglichten (unverzichtbare Voraussetzung für das Entstehen dieser neuen Philologie) oder uns tatkräftig halfen - in erster Linie den Herren Dr. Voigt und Dr. Treue, sowie Herrn Dr. Schefels und Frau G. Krügel, Herrn G. Meier und Frau E.-M. Winkelmann, den Herren G. Hoppen und V. Sieveking.

12. 1. 1982
Institut für Indologie
Universität Köln

K. L. Janert und Ilse Pliester

XIII, 97

HÄR LA-LLÜ K'Ö

(97,aal-97,y)

UMSCHLAG! MIT
ORDINAL TITEL. FEHLT

xm,9^a.g,1- Hs.Q^ . ^14Z9/lg.5ofe>gB. Hgr Lcl-LüI k'ö. Ddtl man, 6LATT 1A

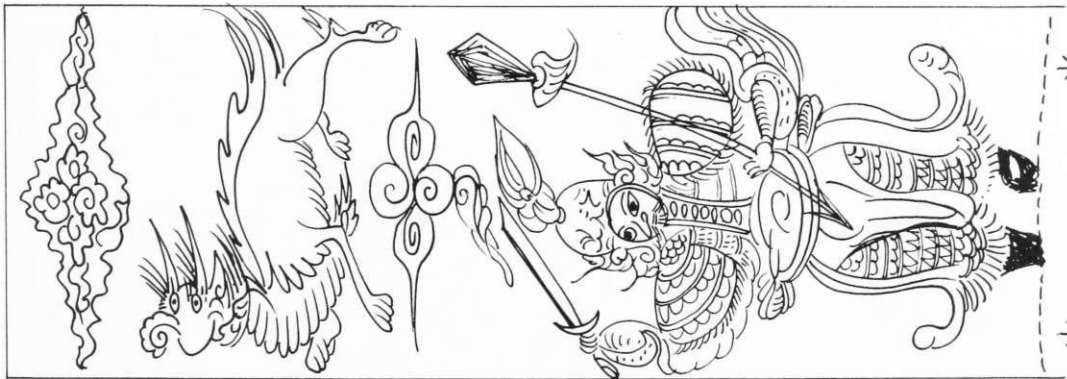
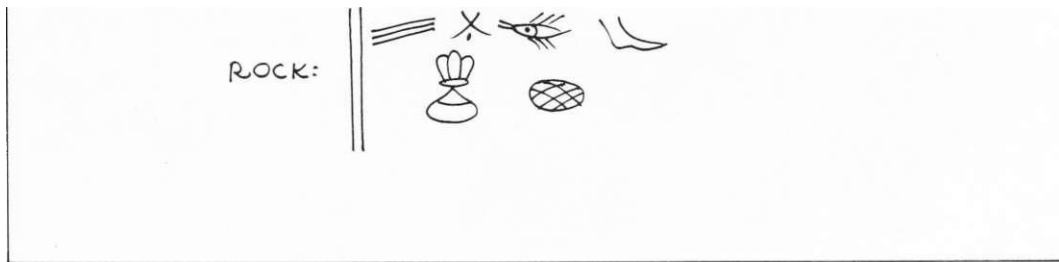

HS.OY-. -14Ä,9/B.50fc8B. BLATT 1*-

ReCHTe HÄLFTE VOM /1r Fe ffLT

LINKE HÄLFTE VON 1v FEHLT

Hs. Or. 1429/R. 5068B. BLATT 1v

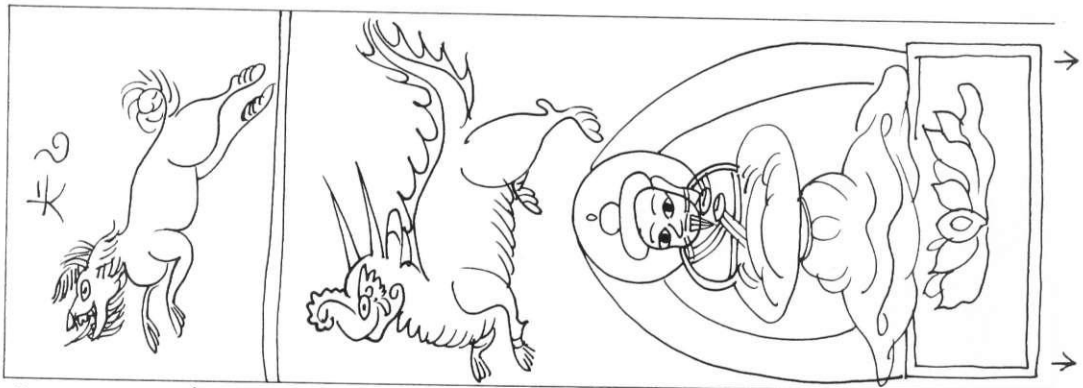
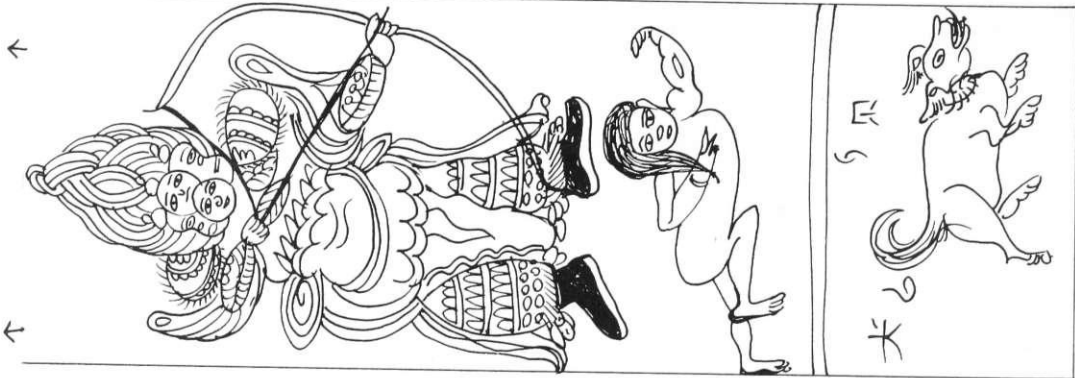

Hs. Or. 1429/R. 5068B. BLATT 2r

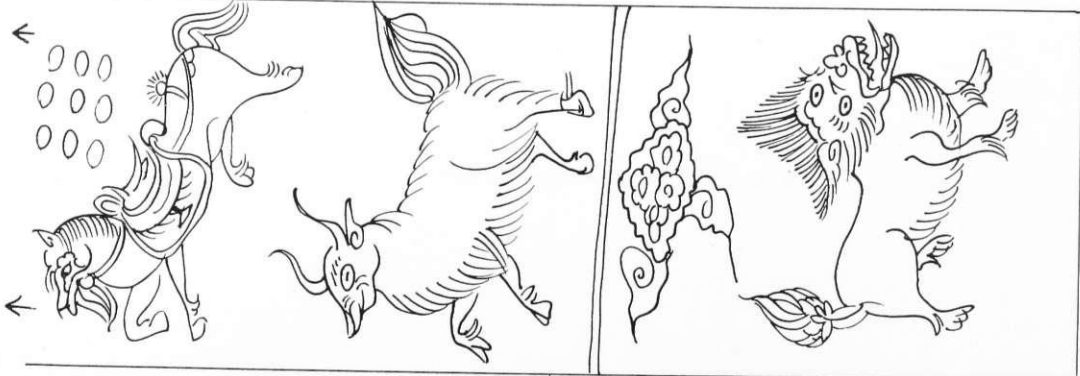

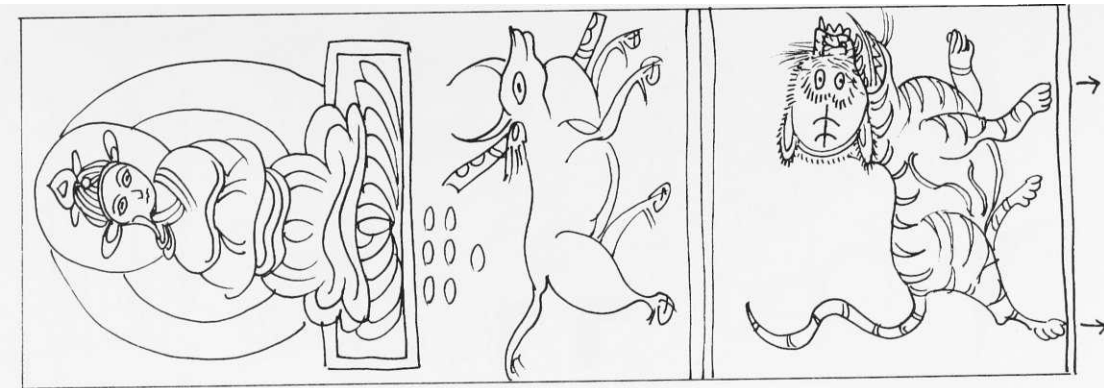

Hs.07. 1429/R.5068 B. BLATT 2v

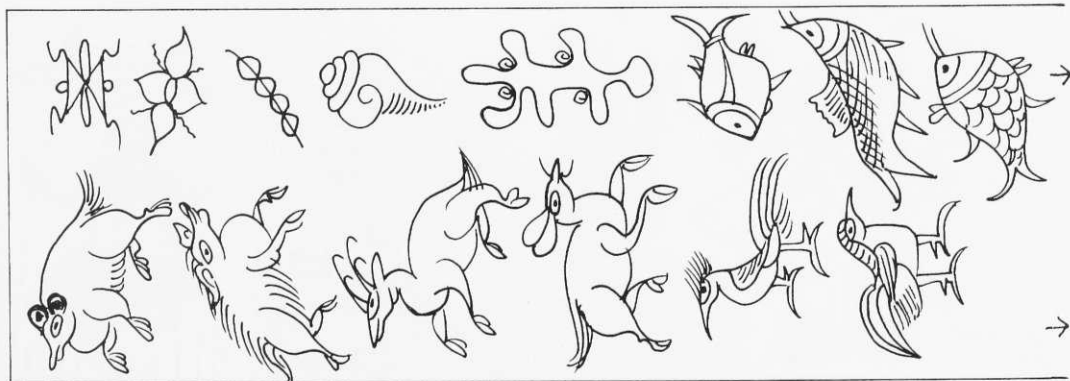
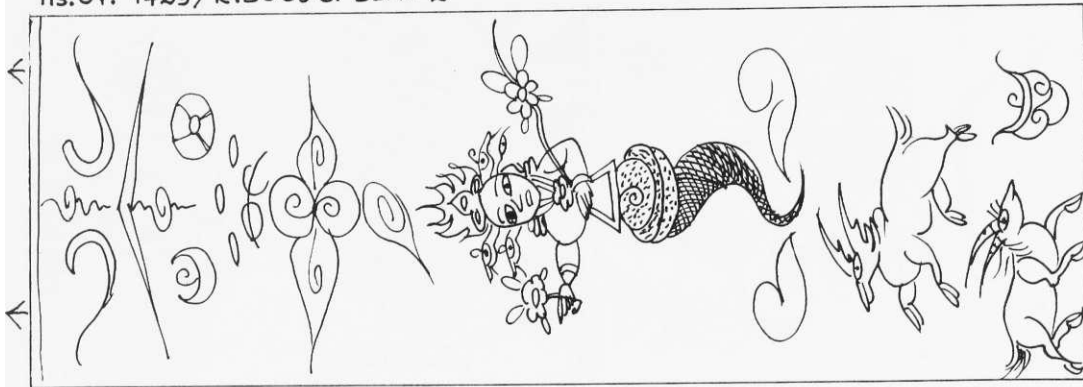

Hs.07. 1429/R.5068 B. BLATT 3r

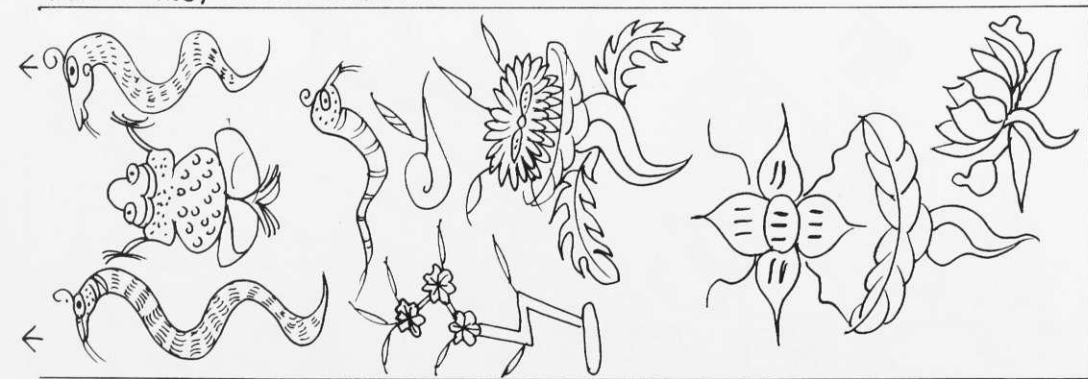

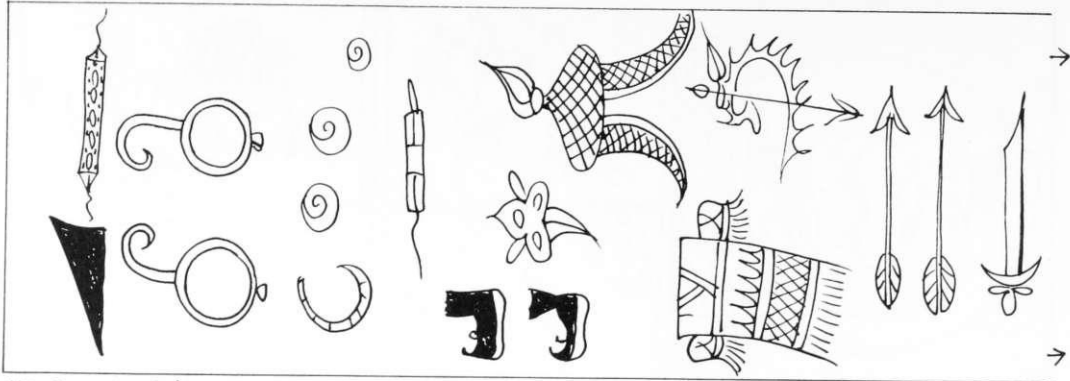

Hs. Ot. 1429/R. 5068B. BLATT 3V

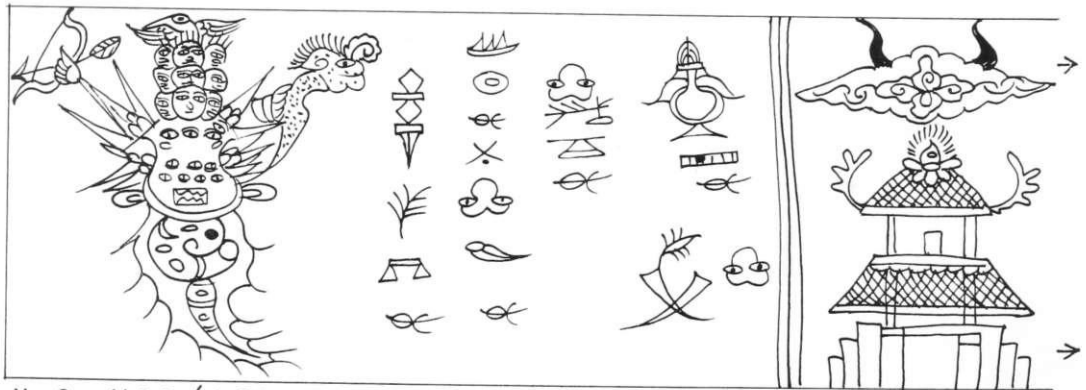
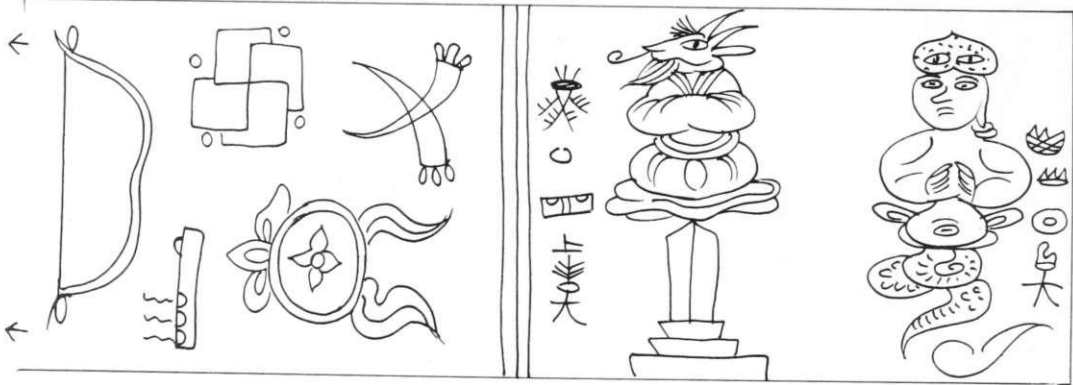

Hs. Ot. 1429/R. 5068B. BLATT 4T

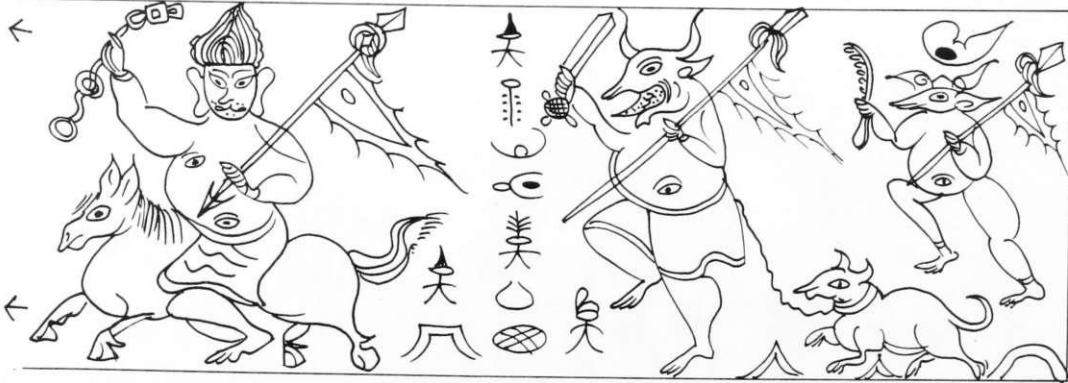



Hs. Or. 1429 / R. 5068 B. BLAT 4^v

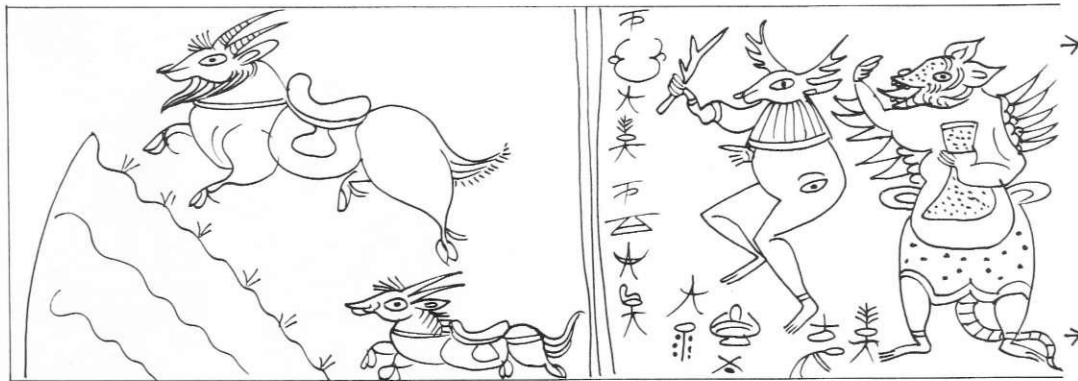

Hs. Or. 1429 / R. 5068 B. BLAT 5^r





HS. 07. 1429/R. 5068 B. BLATT 5v



HS. 07. 1429/R. 5068 B. BLATT 6r



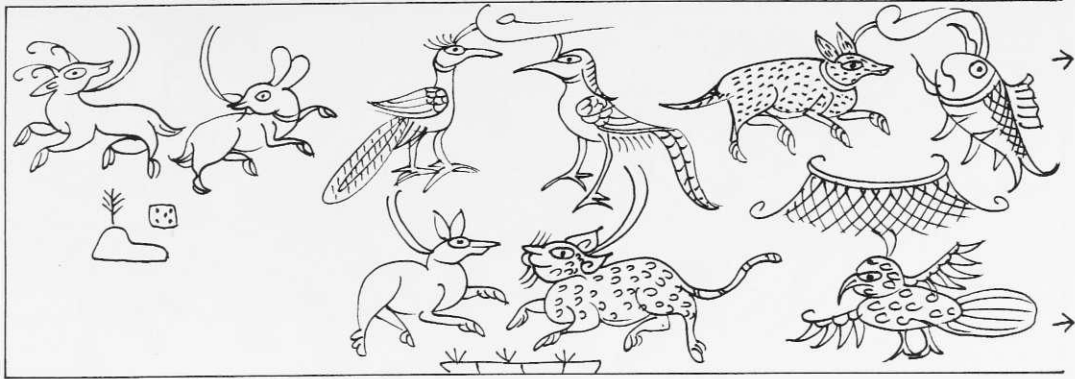

Hs. 07. 1429 / R. 5068 B. BLATT 6^v

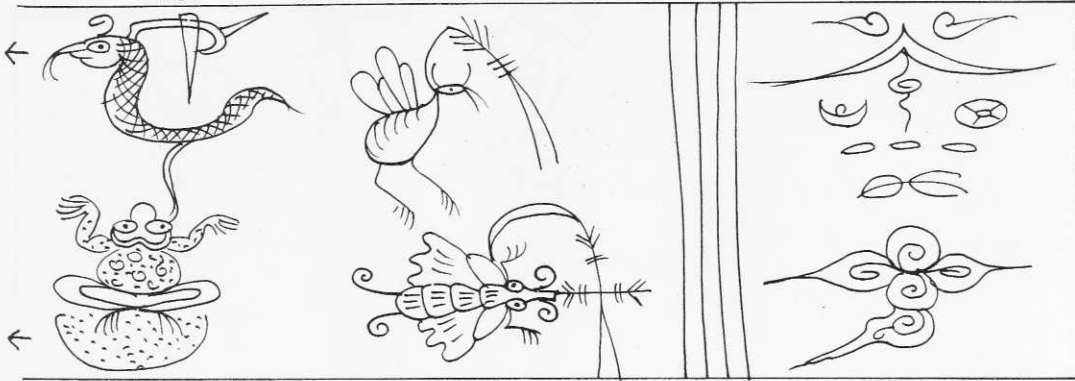

Hs. 07. 1429 / R. 5068 B. BLATT 7^r



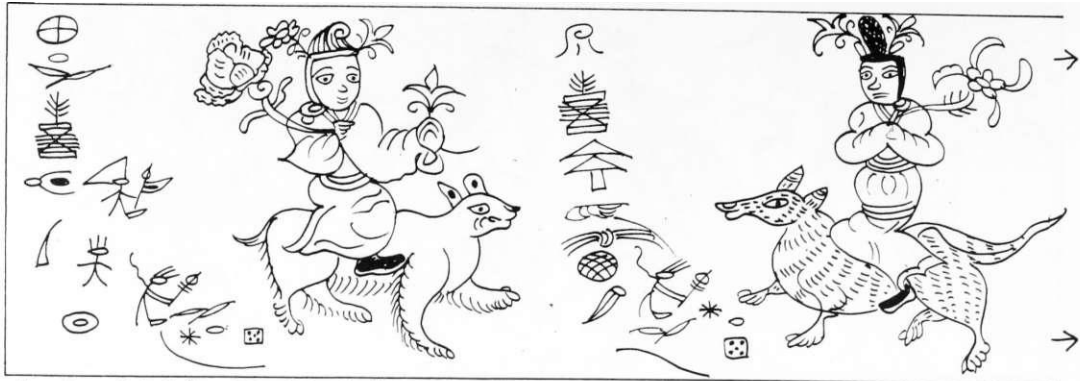

Hs. Or. 1429 / R. 5068 B. BLATT 7 v

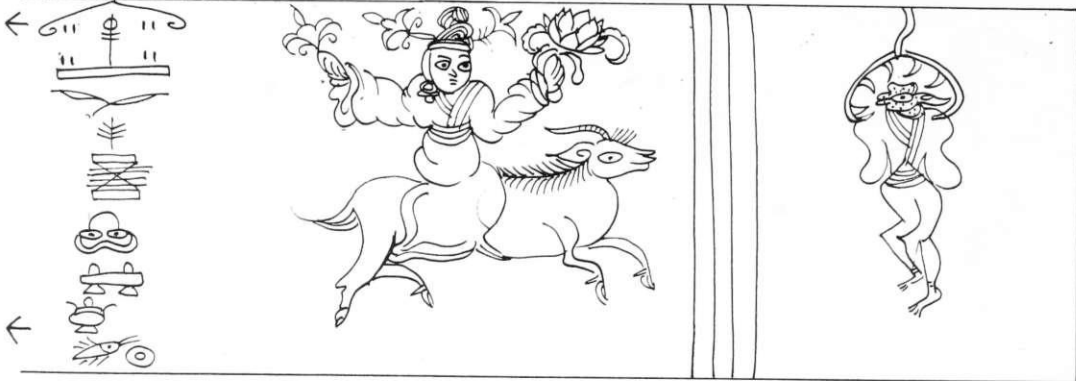

Hs. Or. 1429 / R. 5068 B. BLATT 8 r

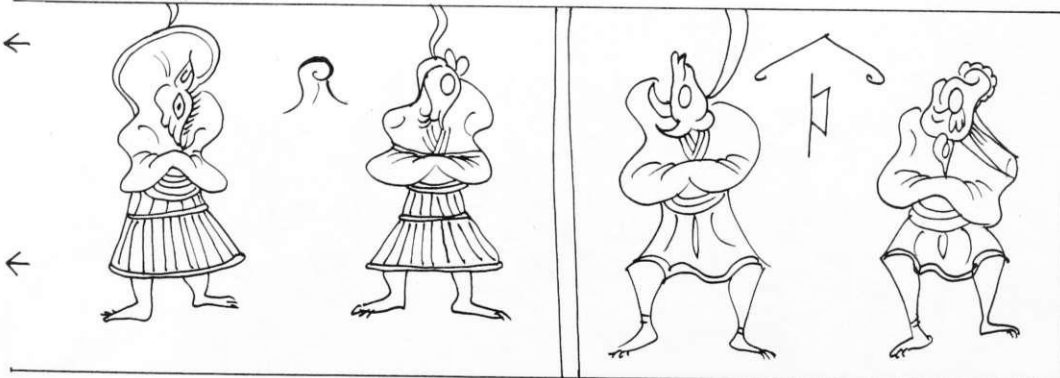

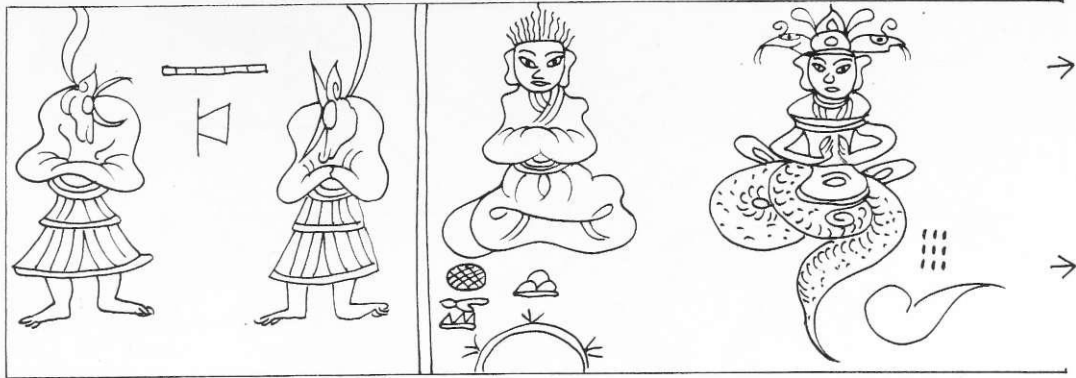

Hs. Or. 1429/R. 5068 B. BLATT 8 v

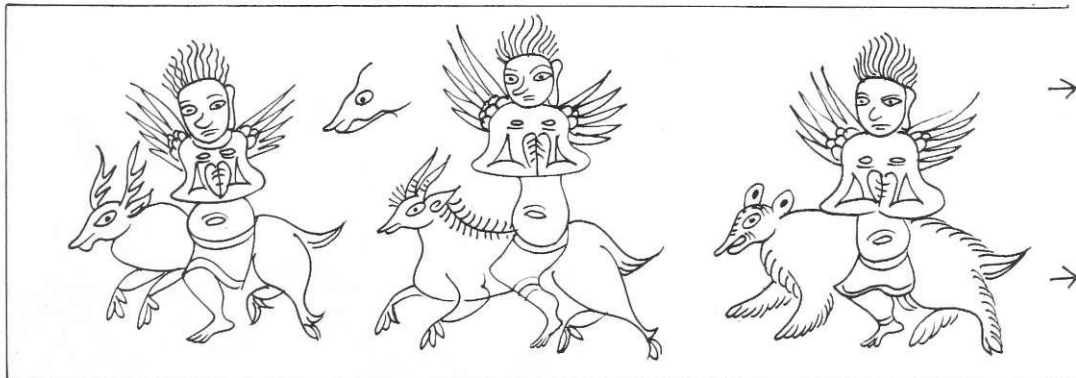
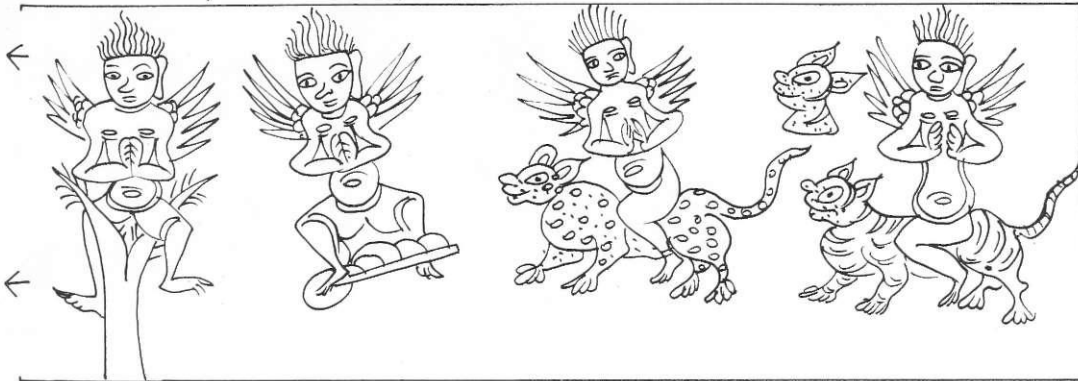

Hs. Or. 1429/R. 5068 B. BLATT 9 r

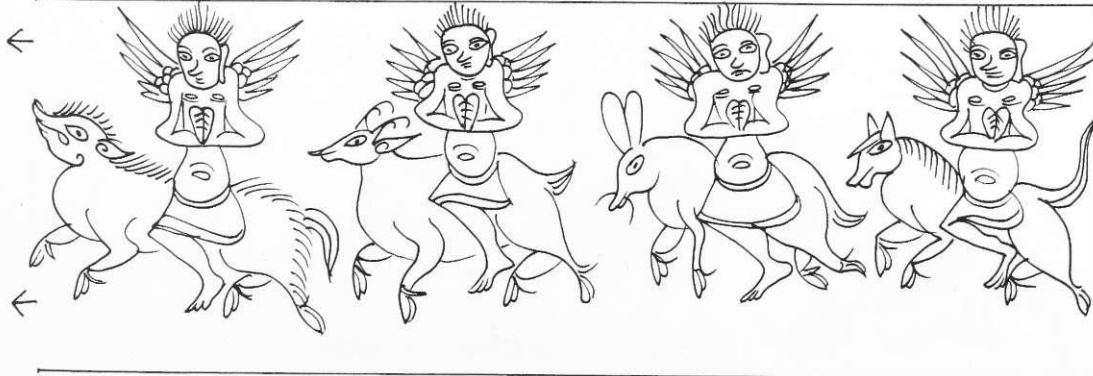

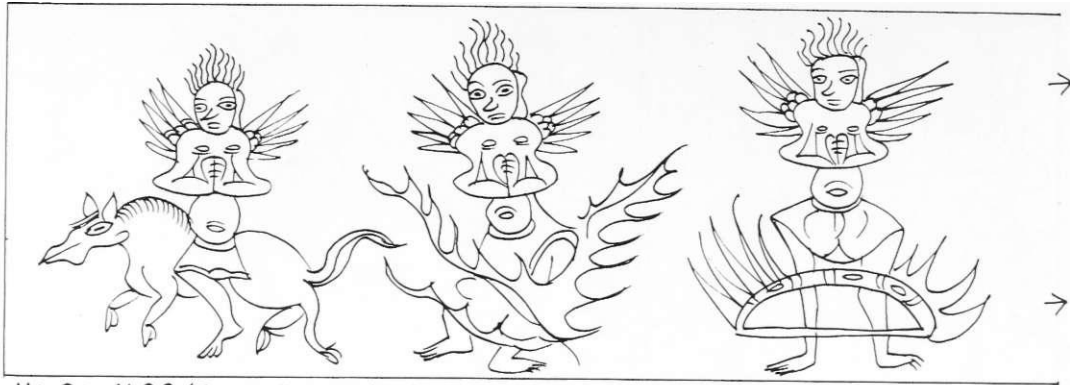

HS. 07. 1429/R. 5068B. BLATT 9V

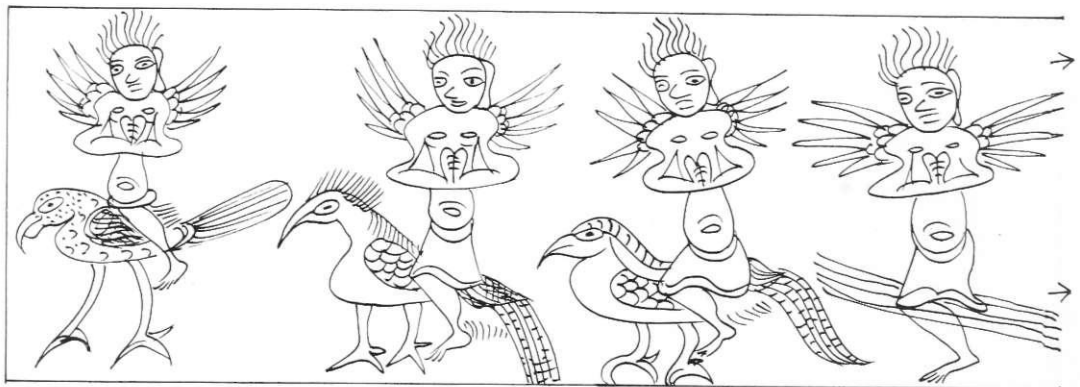
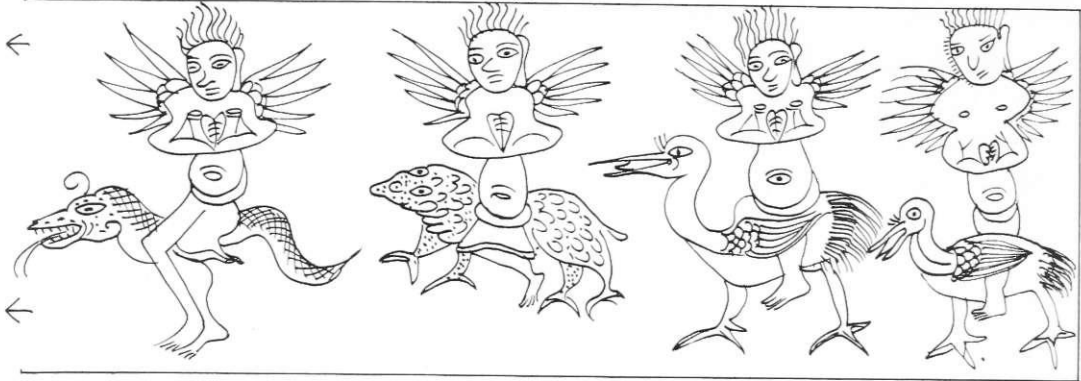

HS. 07. 1429/R. 5068B. BLATT 10V



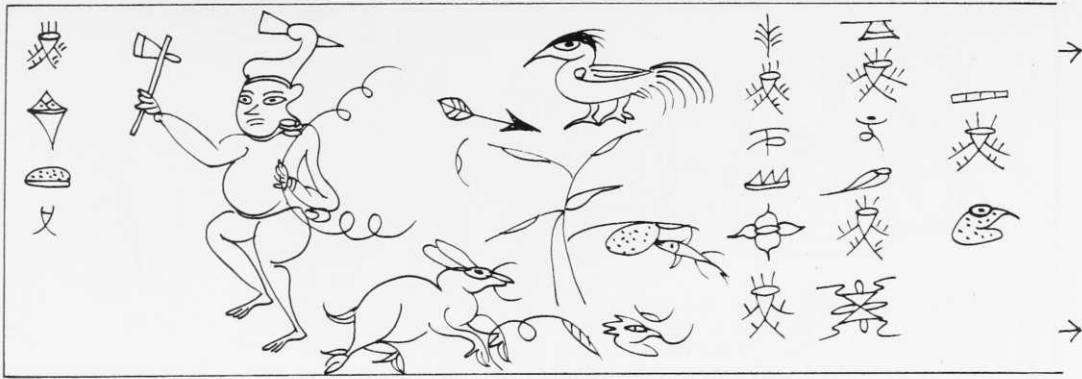

Hs. Or. 1429 / R. 5068 B. BLATT 10v

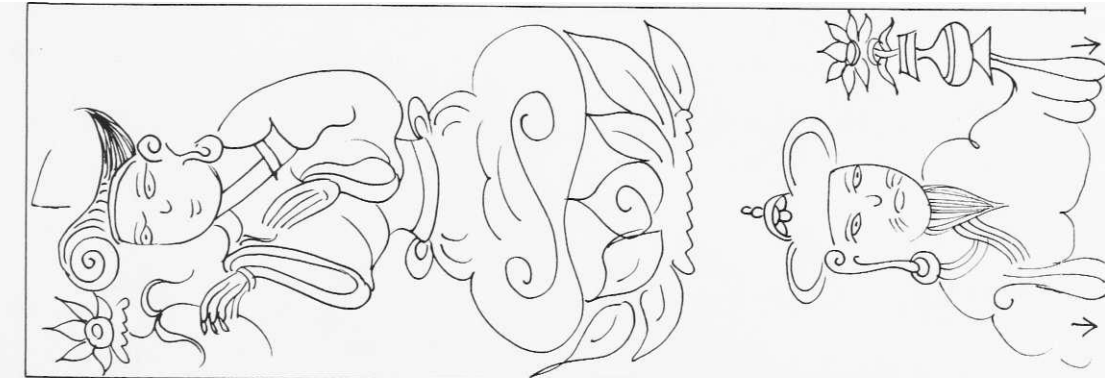

Hs. Or. 1429 / R. 5068 B. BLATT 11v

(BLATT 11r IST NICHT BESCHRIFTET)

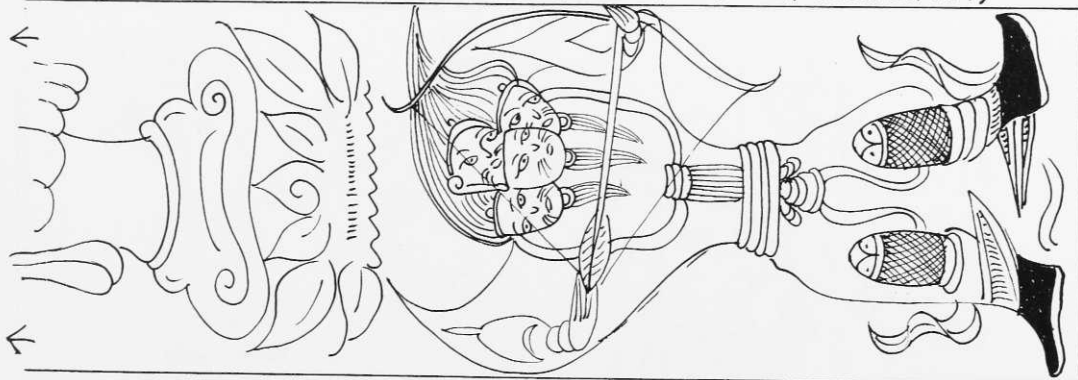

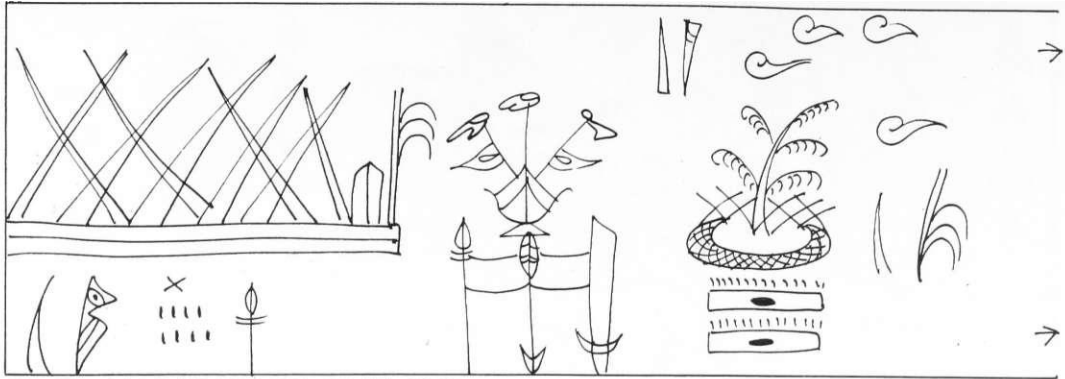

HS. OT. 1429 / R. 5068 B. BLATT 12^r

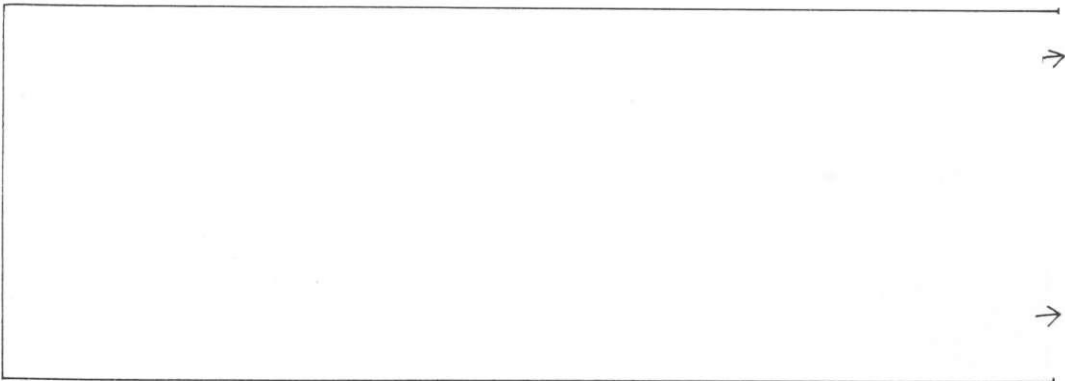
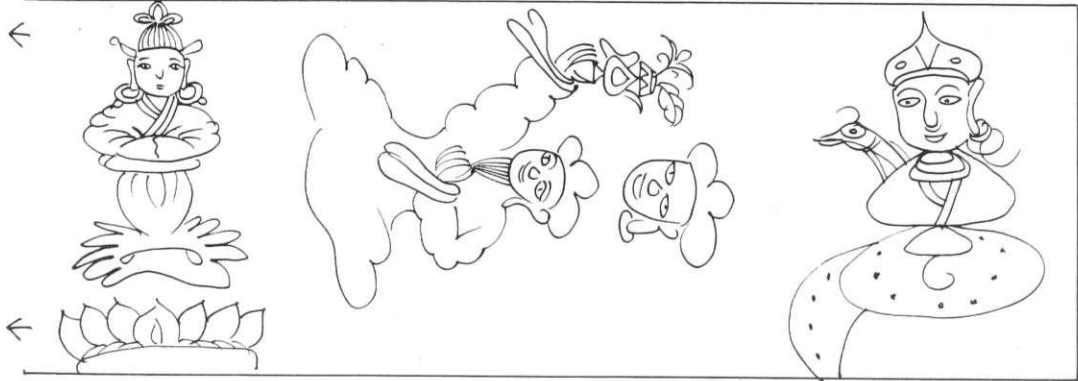

HS. OT. 1429 / R. 5068 B. BLATT 12^v

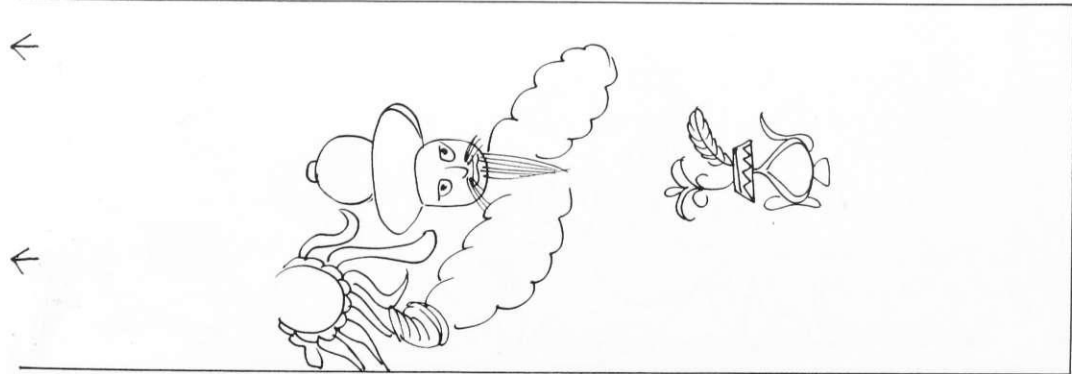

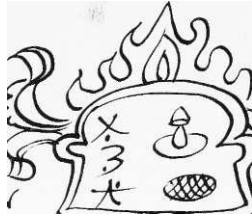

DA/VK HER.RN POTT HIER. DIE VOLLSTÄNDIGE
 Kopie DES ORIGINALS AUS' RIJKS MUSEUM
 YOOR VOLKEN KUNDE, LEIDEN, HOLLAND
 SR. 2/S/ftS. CJETZT 4-1 *S 12>S *

xm^97, gg, 1 - Hs. or, sim. 2X359; 11» Ha-r la.-llutk'ö. Ddu mun. BLATT -j*..''

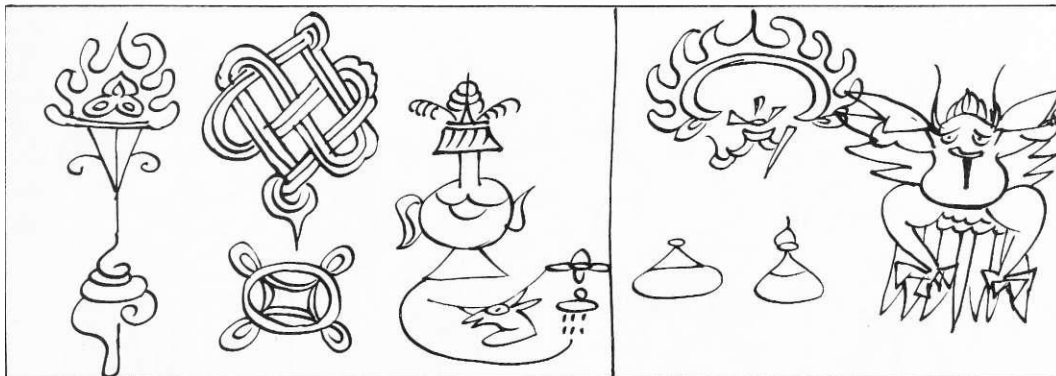

H&.or.sim. 2,059, 11- BLATT



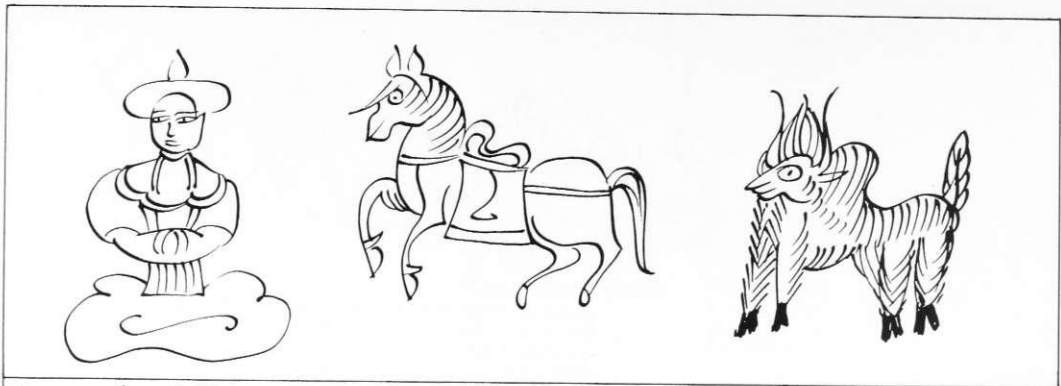

Ms. Or. sim. 2059, 11. BLATT 3r-v

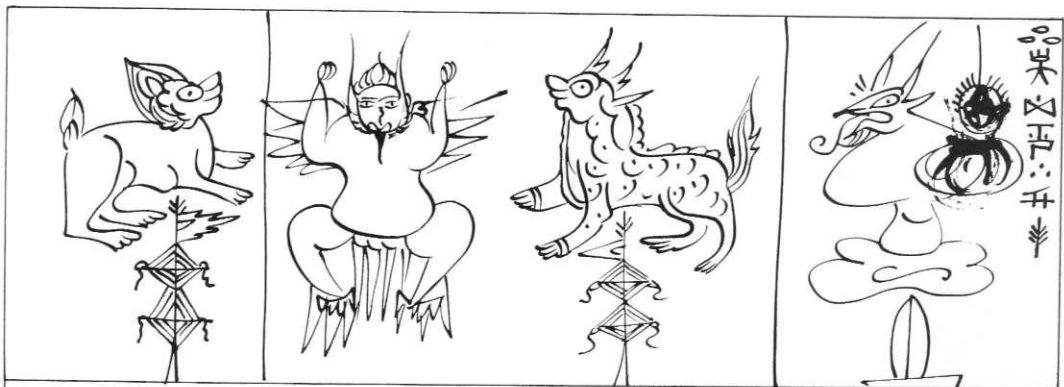
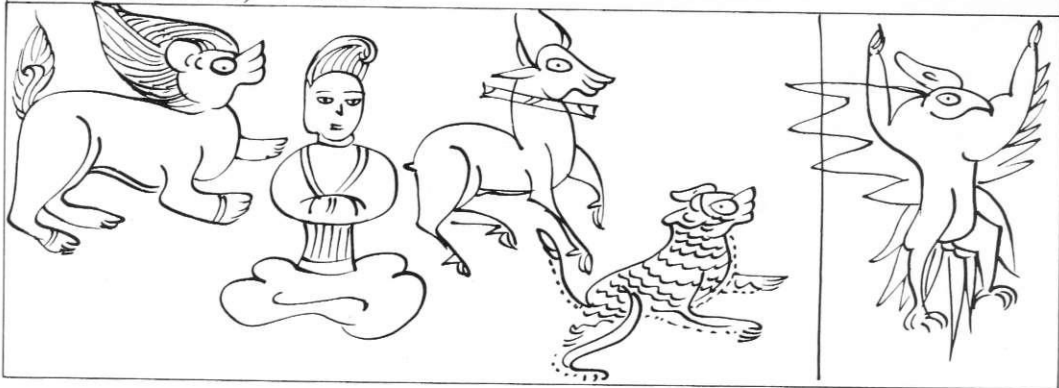

Ms. Or. sim. 2059, 11. BLATT 4r-v



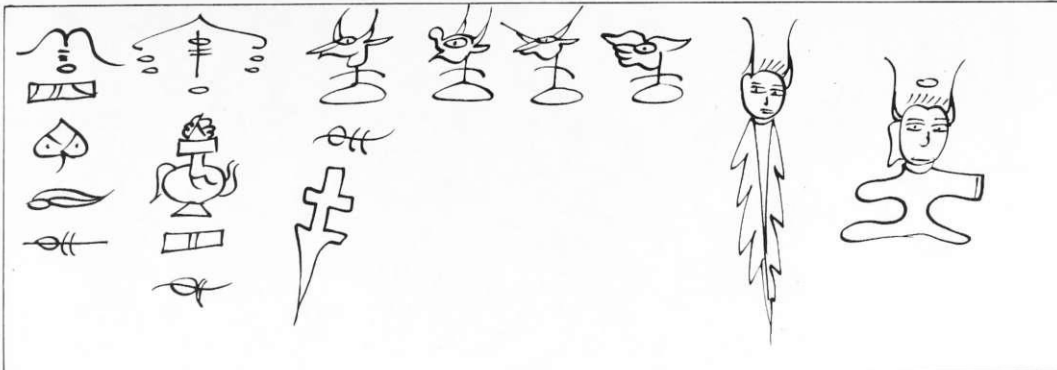

Hs. Or. sim. 2059, 11. BLATT 5⁺-v



Hs. Or. sim. 2059, 11. BLATT 6⁺-v

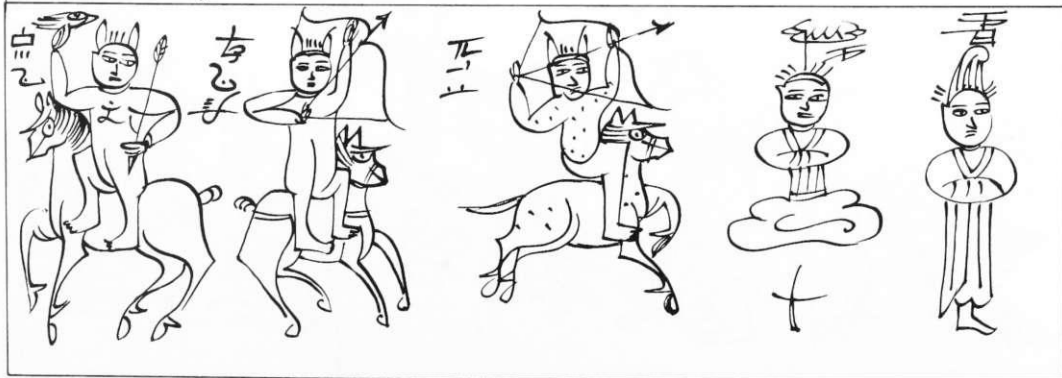



Hs. or. sim. 2059, 11. BLATT 7 r-v

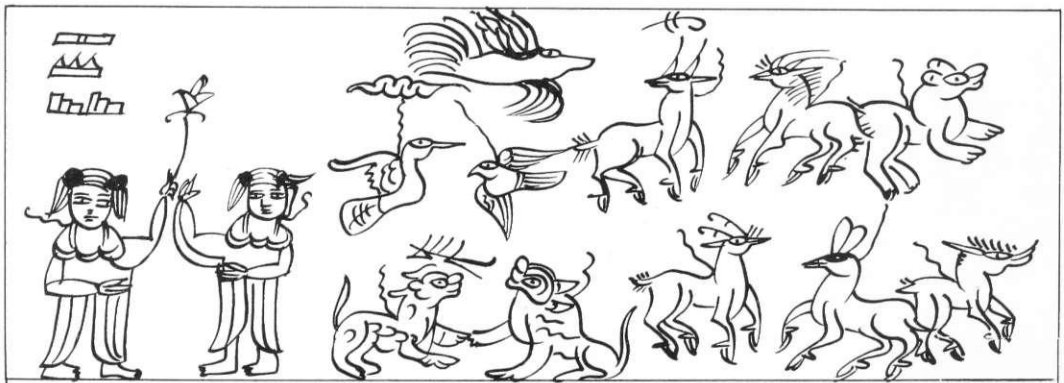

Hs. or. sim. 2059, 11. BLATT 8 r-v

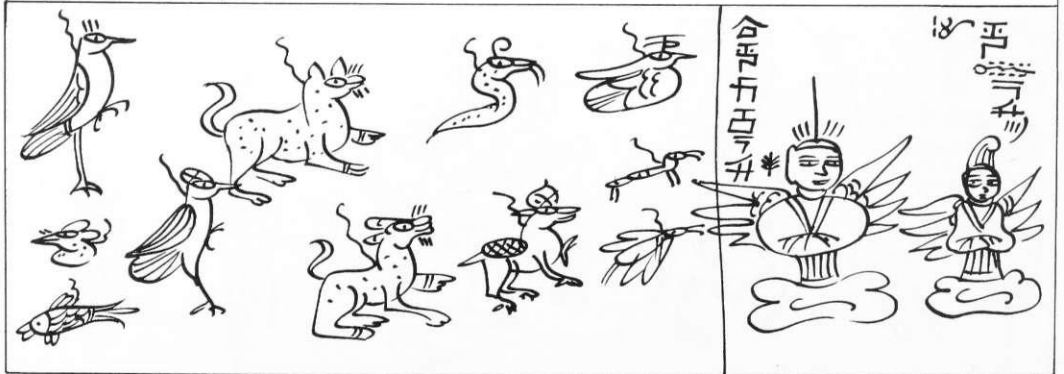



Hs. or. sim. 2059, 11. BLATT 9 r - v

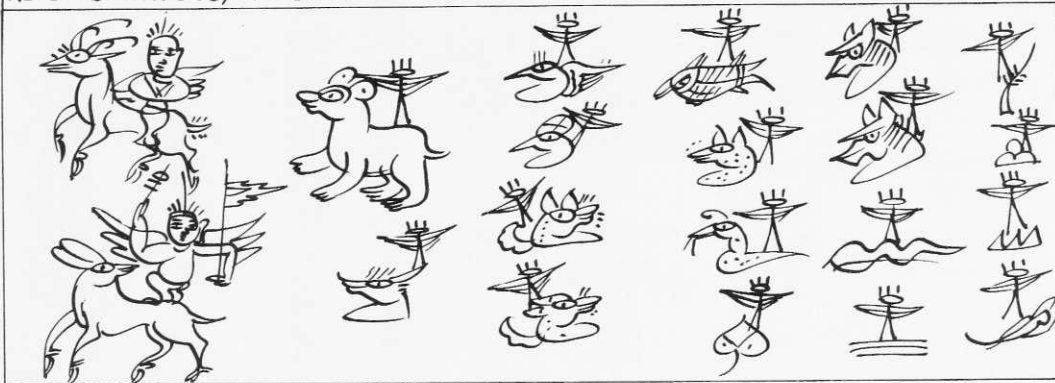

Hs. or. sim. 2059, 11. BLATT 10 r - v





Hs. Or. sim. 2059, 11. BLATT 11r-v

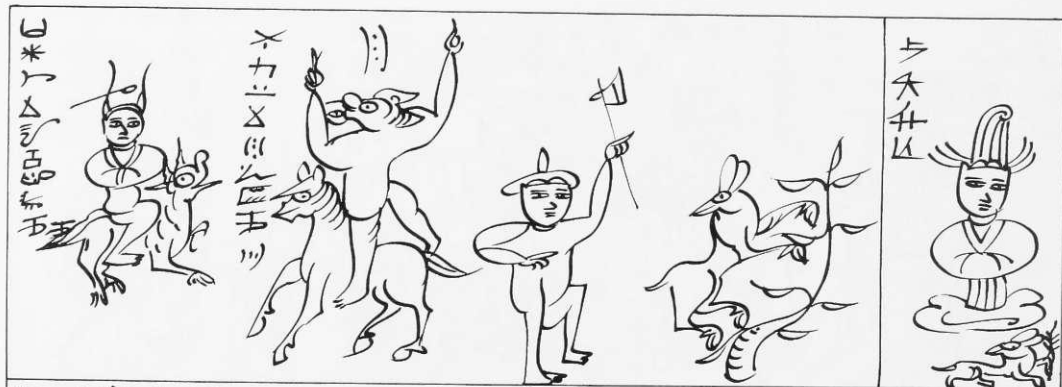
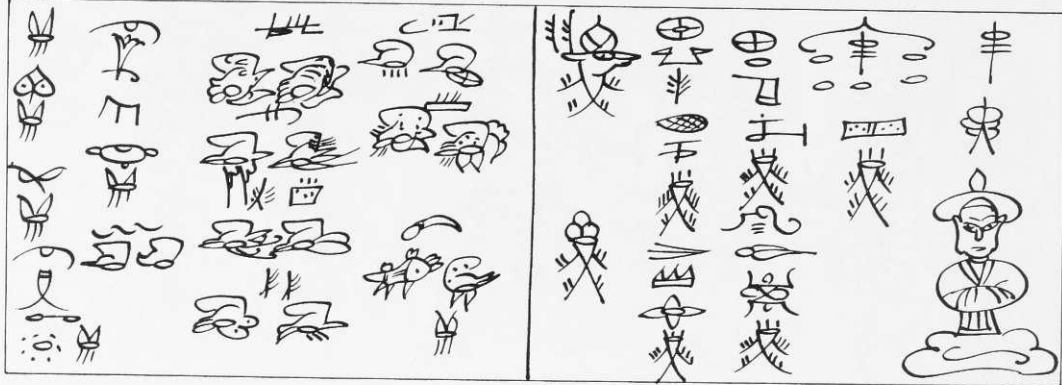

Hs. Or. sim. 2059, 11. BLATT 12r-v





Hs. 07. sim. 2059, 11. BLATT 13 r-v

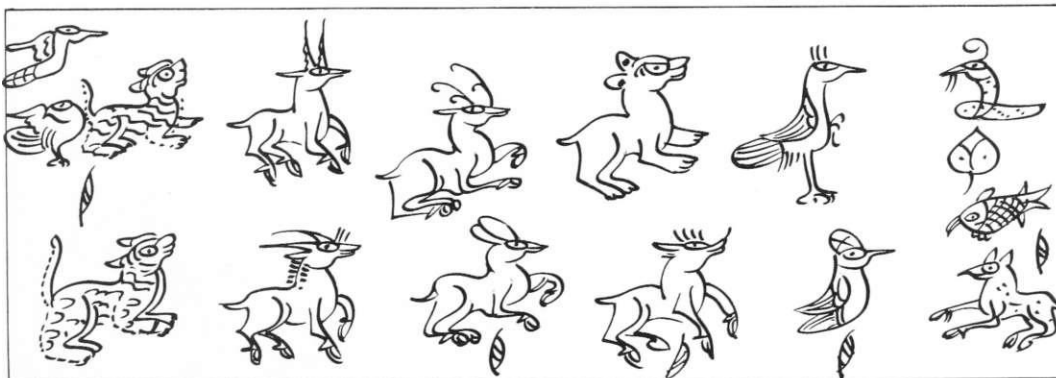
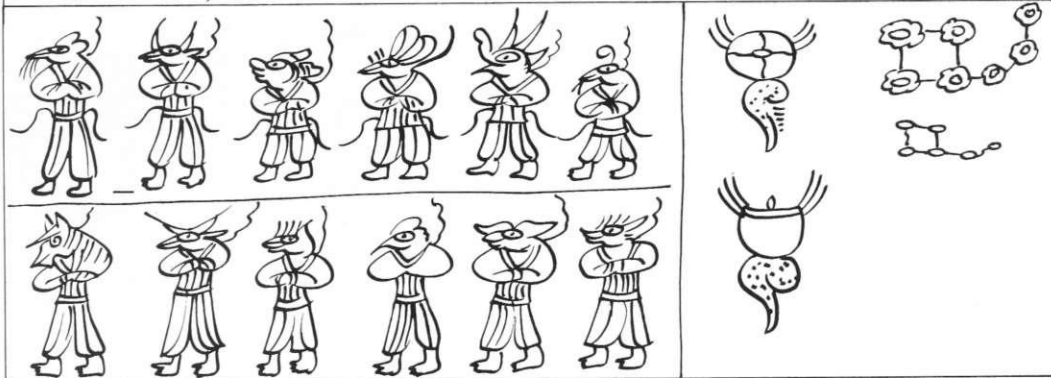

Hs. 07. sim. 2059, 11. BLATT 14 r-v

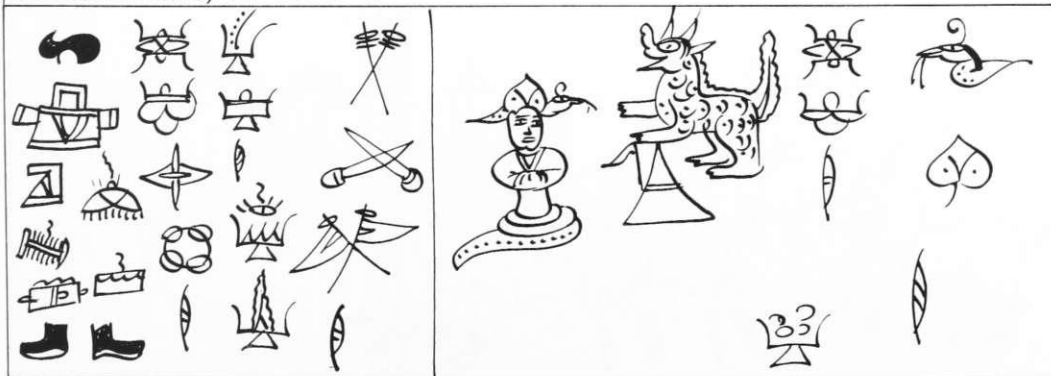

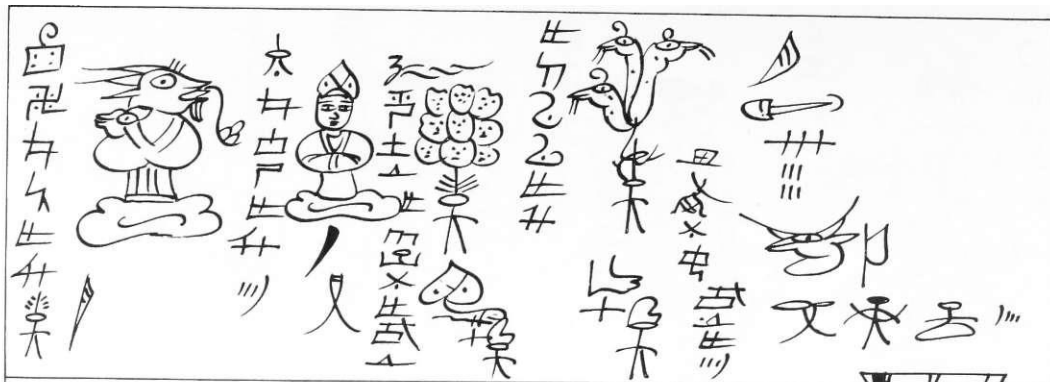

Hs. Or. sim. 2059, 11. BLAT 15†-v

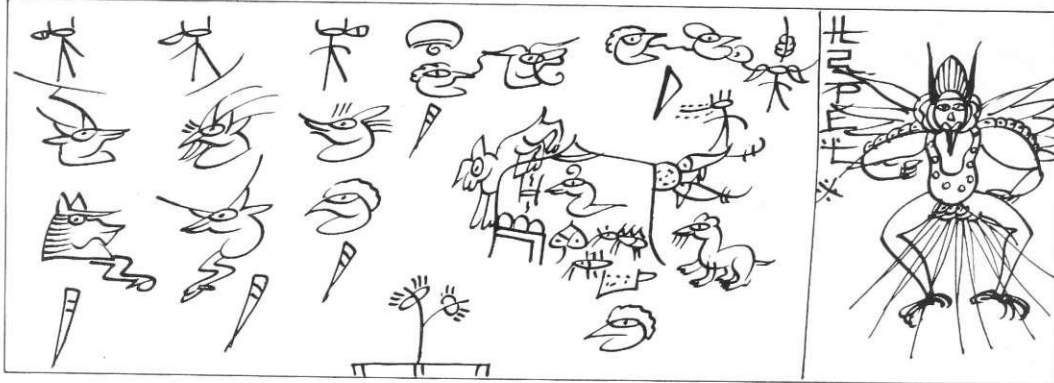

Hs. Or. sim. 2059, 11. BLAT 16†-v

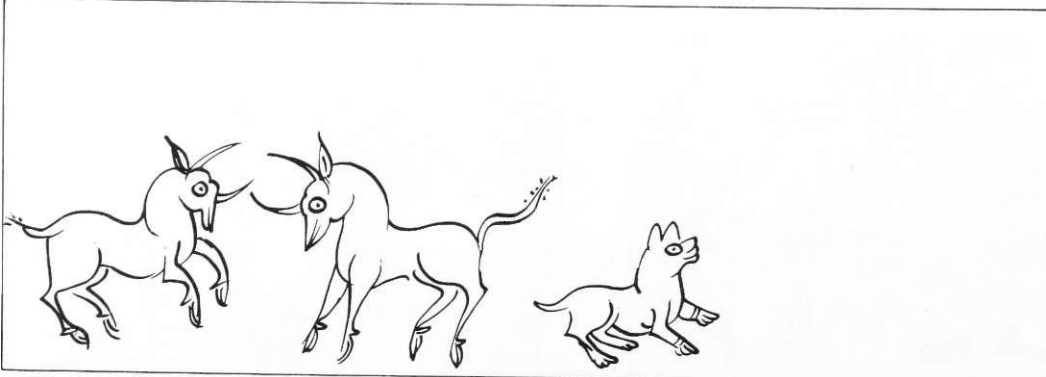

ORiqiNALTITEL FEHLT

Xlii. 97, act, 1 - k.0T.ZQL/K-.8WŞ&. Har Ui-llü. k'6. Ddu-mun, BUTT 1 A

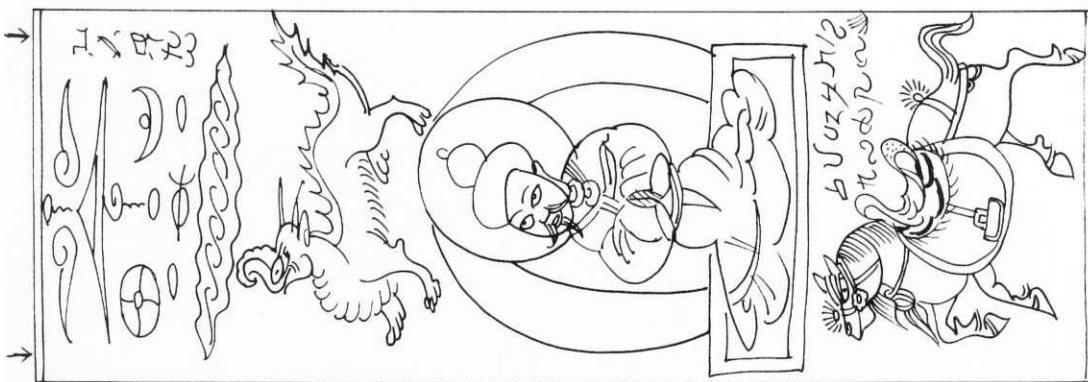
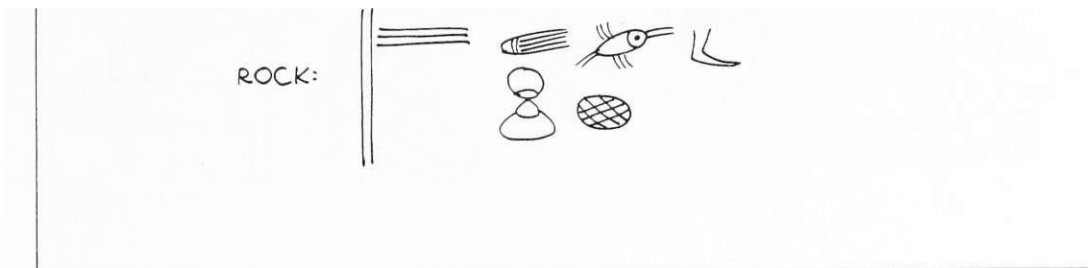

K.O.T. 202/R.8193A. BLATT 1T

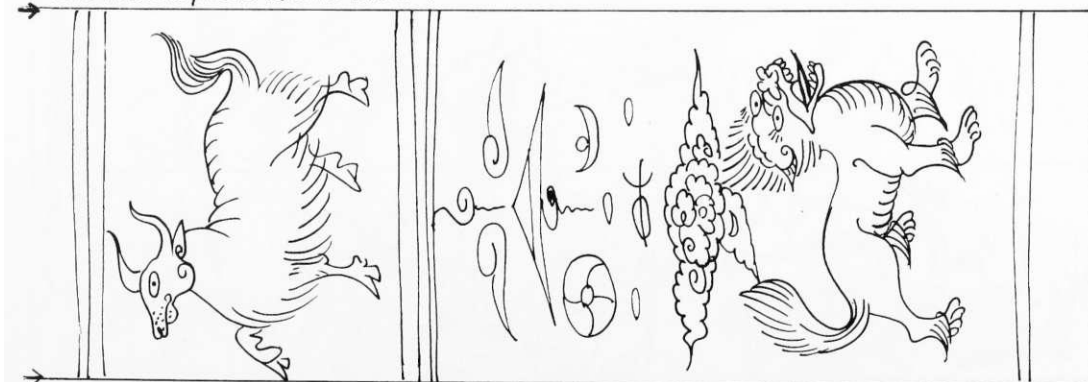

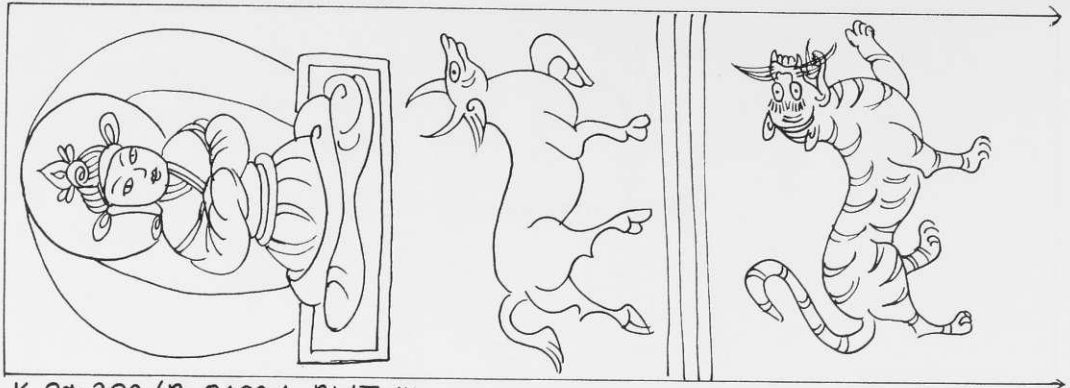

K. 07. 202 / R. 8193 A. BLATT 1V

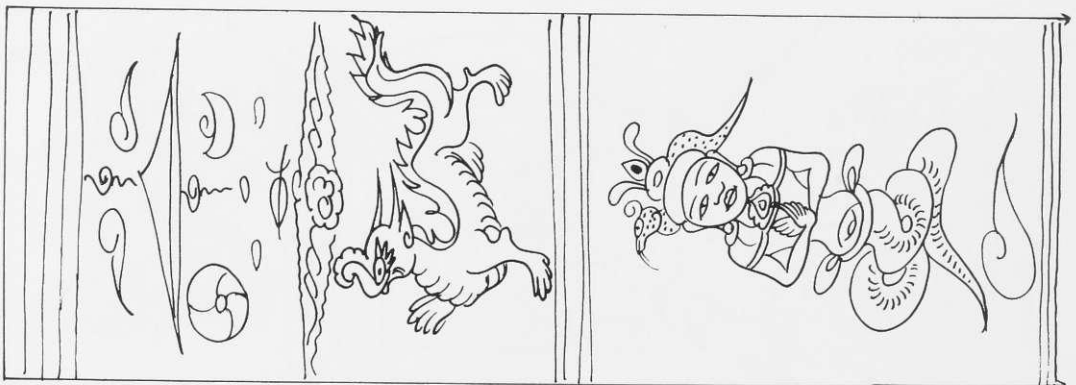
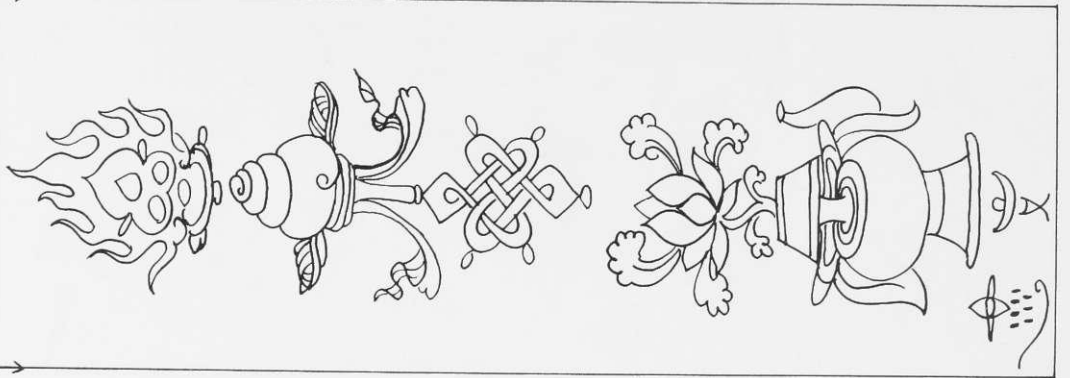

K. 07. 202 / R. 8193 A. BLATT 27

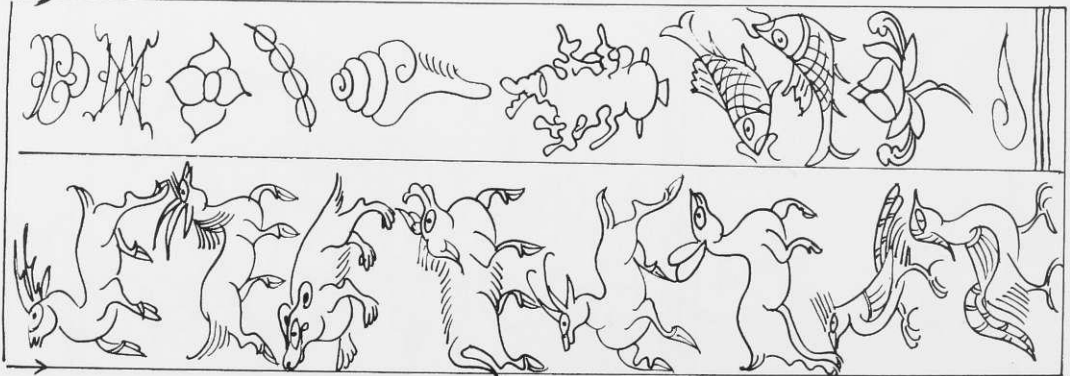

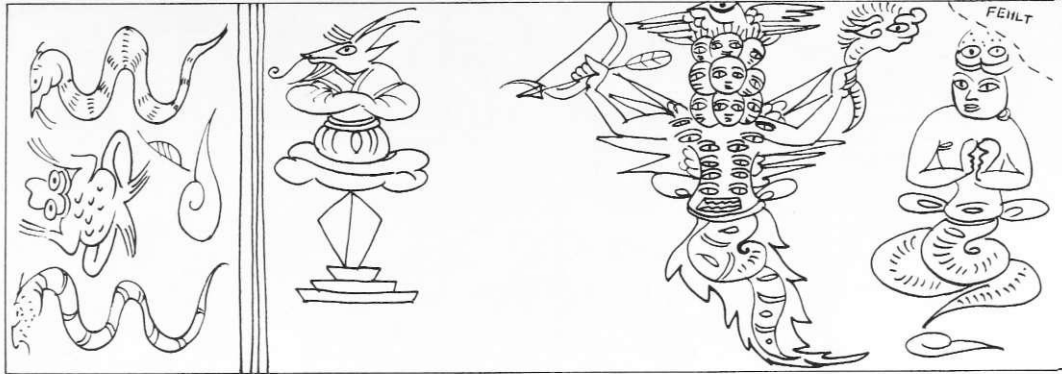

K. Or. 202 / R. 8193 A. BLATT 2v



K. Or. 202 / R. 8193 A. BLATT 3r





K. O. 202 / R. 8193 A. BLATT 3^v



K. O. 202 / R. 8193 A. BLATT 4^r



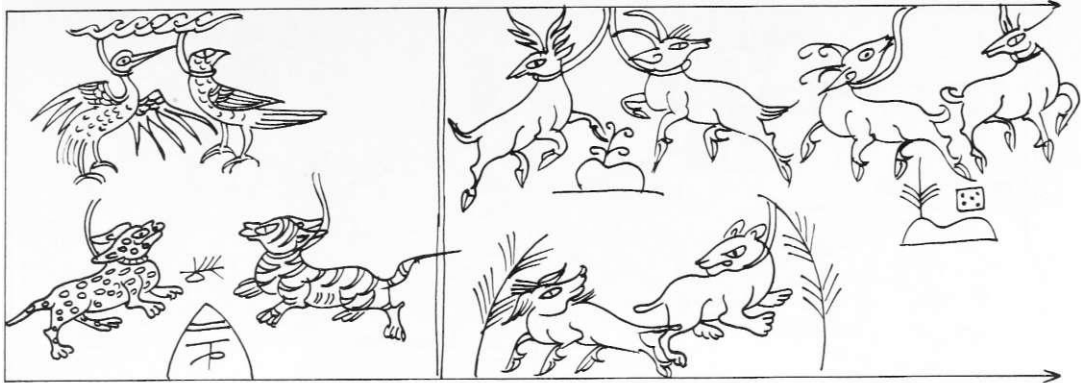

K. O. 202 / R. 8193A. BLATT 4v

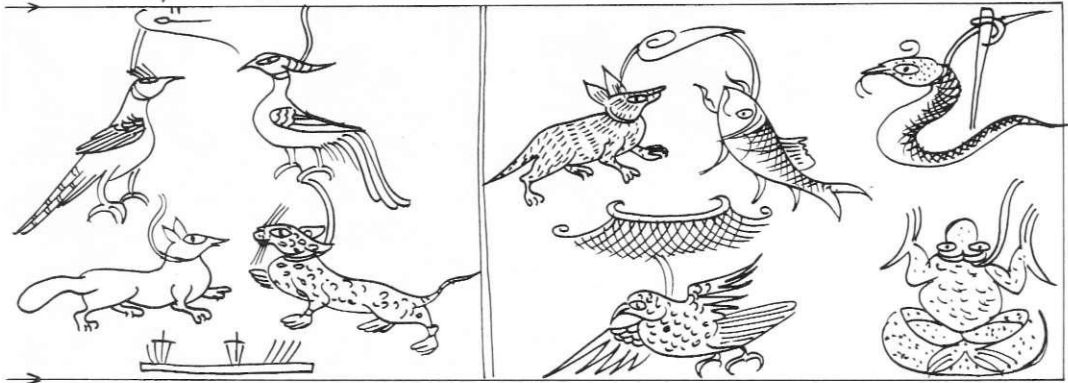

K. O. 202 / R. 8193A. BLATT 5r



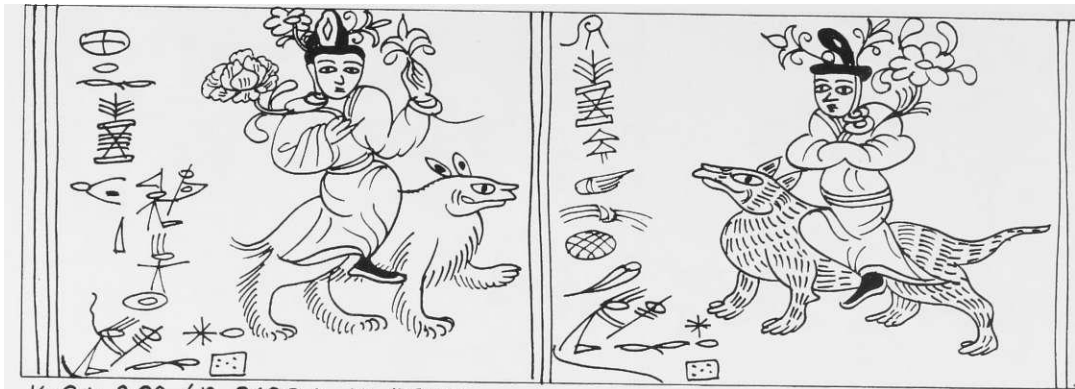

K.Ot. 202 / R.8193A. BLATT 5v



K.Ot. 202 / R.8193A. BLATT 6r



K. O. T. 202 / R. 8193 A. BLATT 6^v



K. O. T. 202 / R. 8193 A. BLATT 7^r

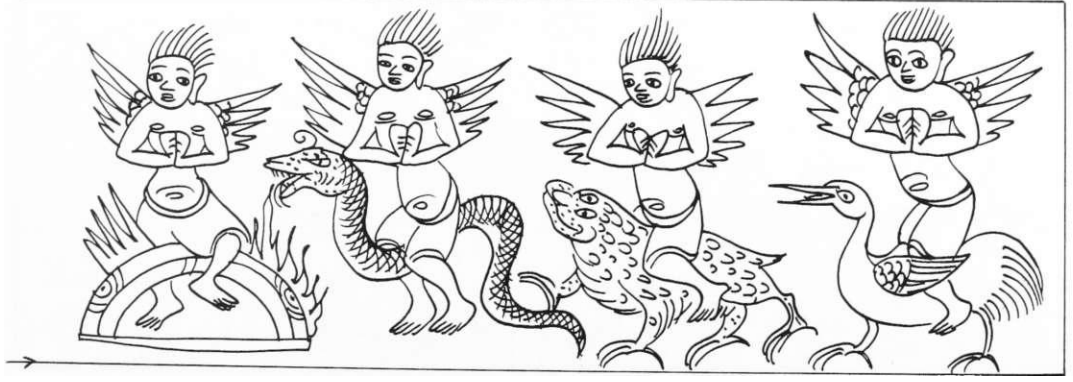

K. O. 202 / R. 8193A. BLATT 7v



三
二
一
十
六

K. O. 202 / R. 8193A. BLATT 8r-v

XIII, 97, a a, 2

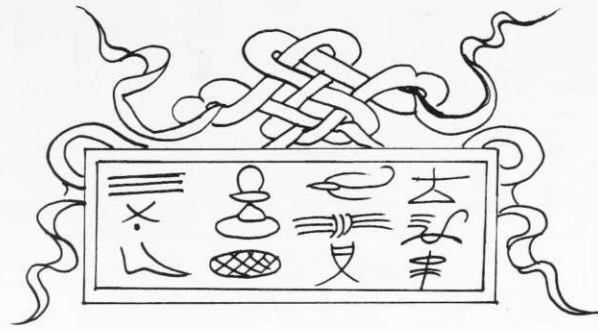

XIII, 97, a a, 2 - Hs.or.sim. 620/R. 2252. Hät la-llü kö, Ddu-mun, Dtër bpö; Dsä bpö. BLATT 1T-v

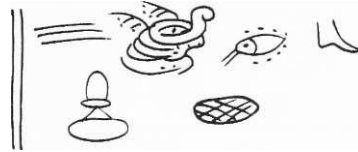

y V 2r=a ^	
Hs.or.sim. fc2.0/R.i2,5Z. BLATT Ä/r--v	
	• 1
	1

LSI V- Vi', - " U
 1111 j k j ",
 1111 rV17

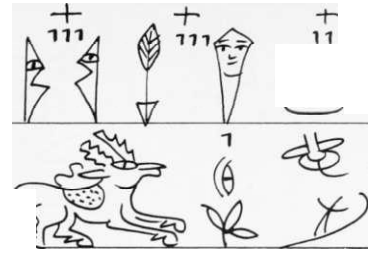

X in
 in



4 in X

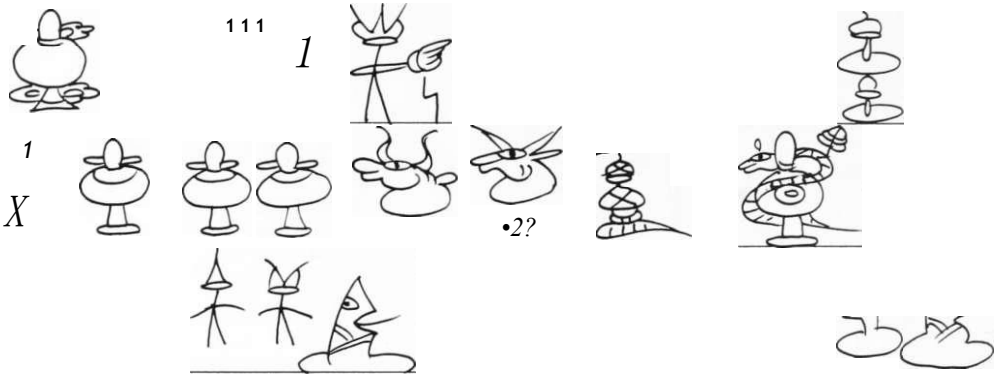

EDS)

um n (St ^



Hs.or.sim. fciO/R.2,2,52,, BLATT V''



$\{^{\wedge}Y^{\wedge} \wedge 0\%$	$\pounds 3$
<p>HS.or. sim. fcio/ft. ZSZ, BLATT 5 ^ "</p>	

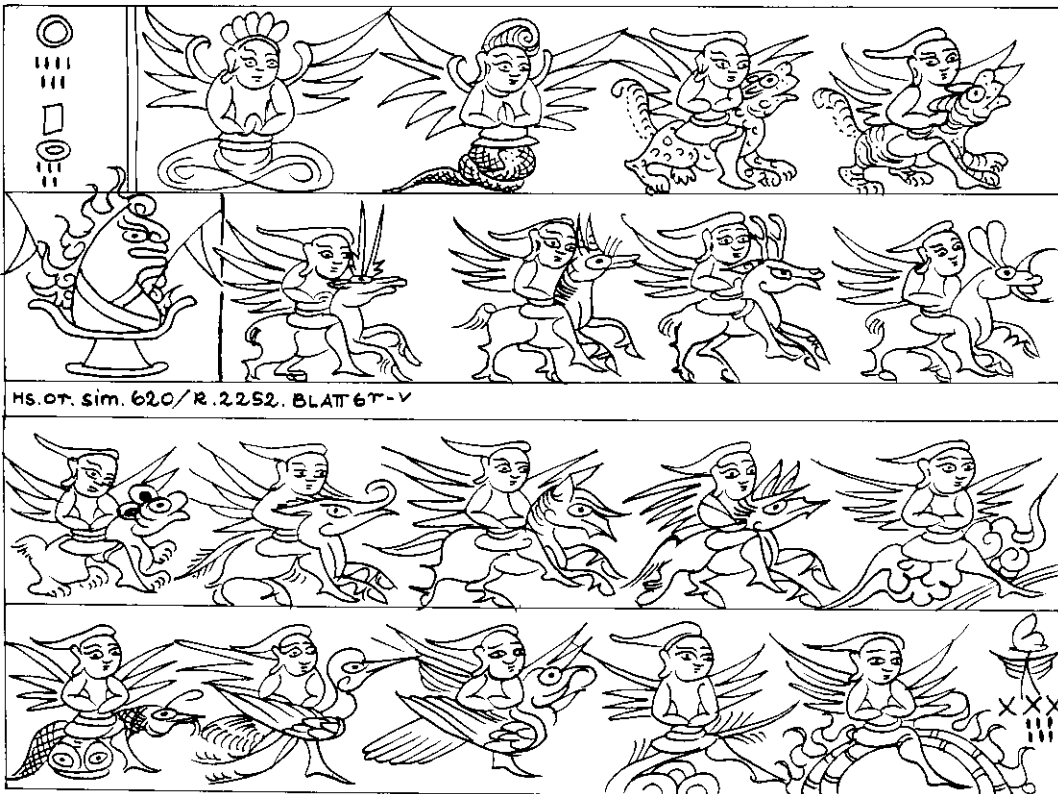



Ms. Or. sim. 620/R. 2252. BLATT 77-v



Ms. Or. sim. 620/R. 2252. BLATT 87-v





Ms. or. sim. 620/R. 2252. BLATT 97-v



Ms. or. sim. 620/R. 2252. BLATT 107-v



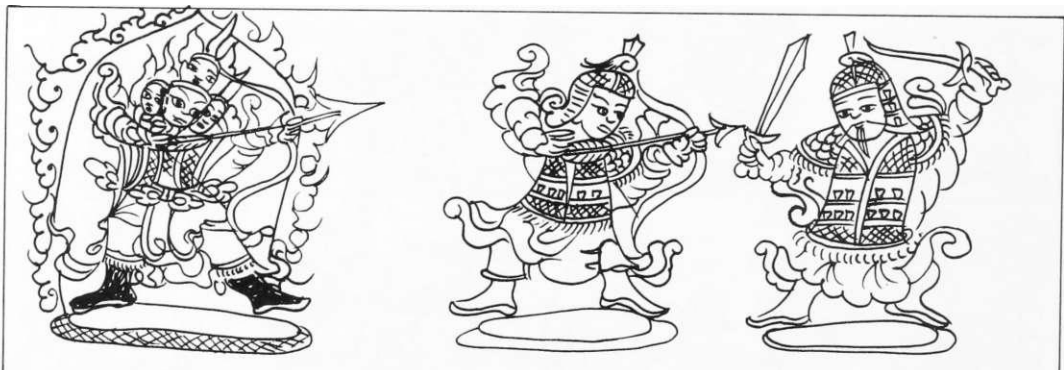

HS. or. sim. 620/R. 2252. BLATT 12, T-V

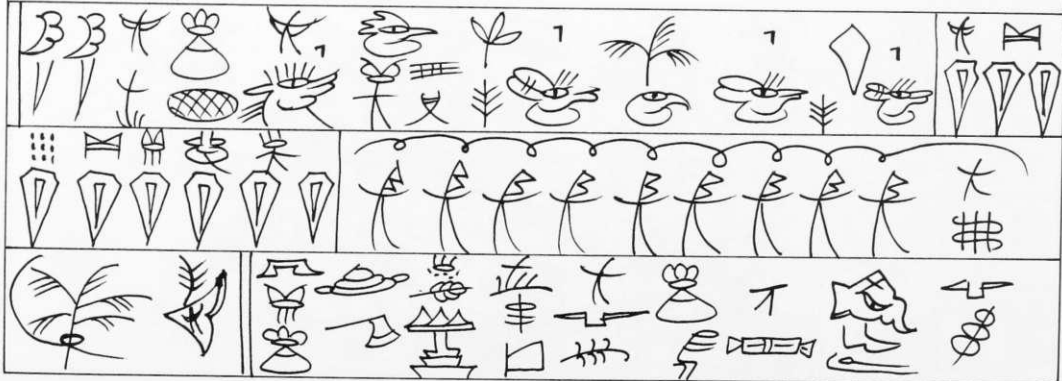

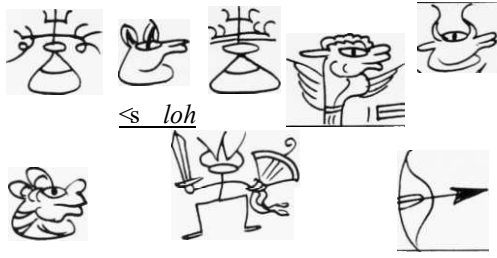

s loh

X

UM

f f i i

Hs.OT-.sim. <O%O/<Q.,%2JS% SLAT 131"-^

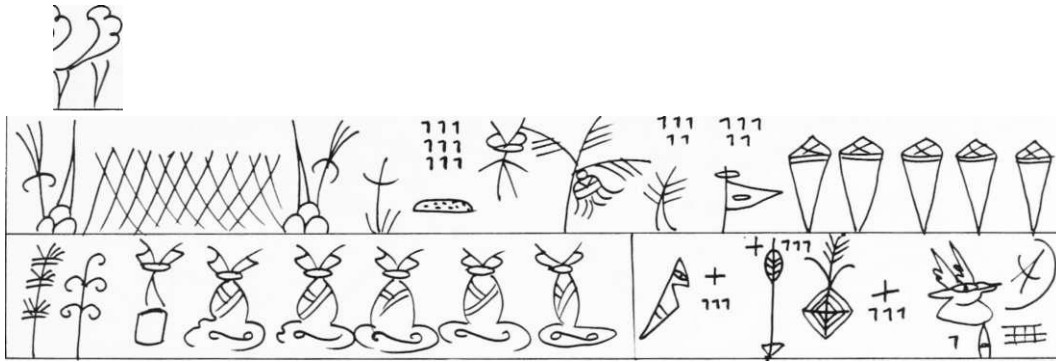

HS. or. Sim. fc2,o/R,. XSLSS,, BLATT 1HT-

I.

ཇ
ཇ
ཇ
ཇ

XIII, 97, a a, 3 - K.Ot. 203/R. 8198A. Häṅ la-llü k'ö. K'o byu Ddu-muṅ. BLATT 1ṅ-v



K.Ot. 203/R. 8198 A. BLATT 2ṅ-v





K. O. 203 / R. 8198A. BLATT 3^{r-v}

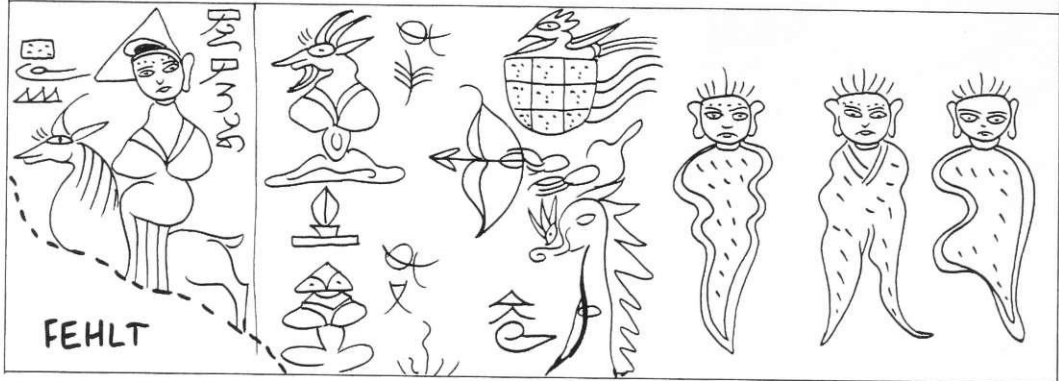

K. O. 203 / R. 8198A. BLATT 4^{r-v}



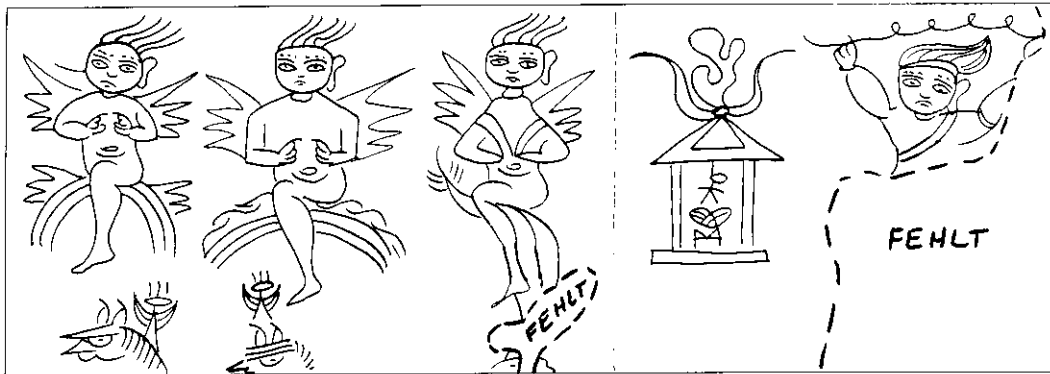

K. O^r. 203 / R. 8198 A. BLATT 5^r-v

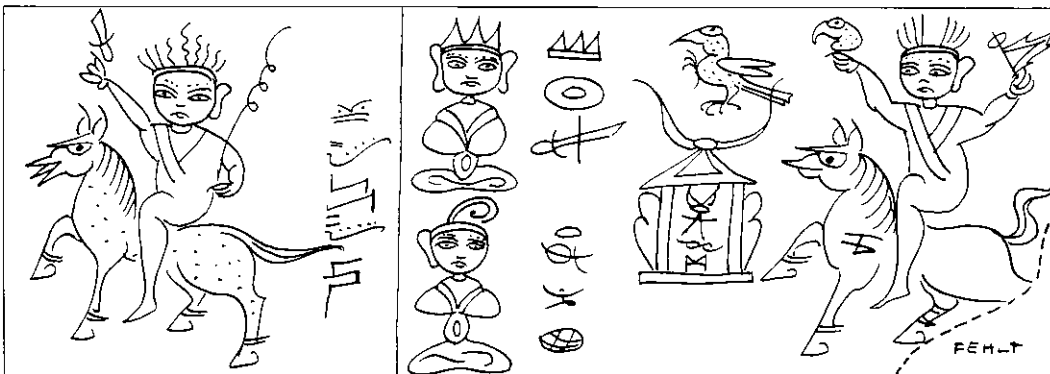
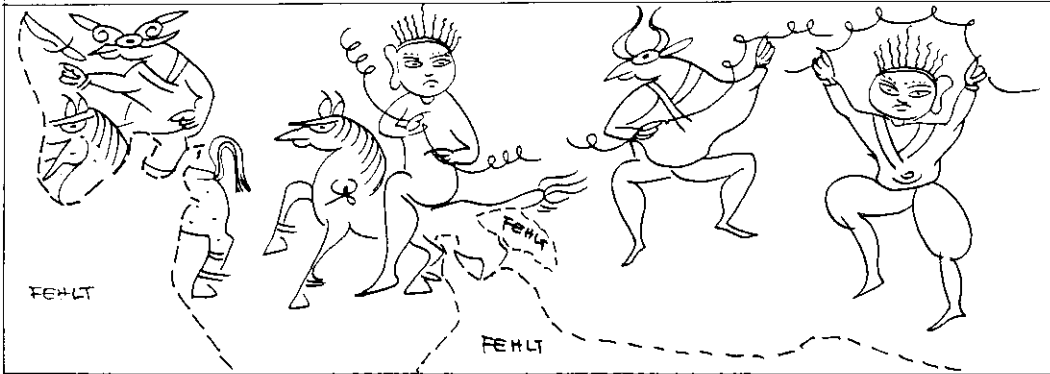

K. O^r. 203 / R. 8198 A. BLATT 6^r-v

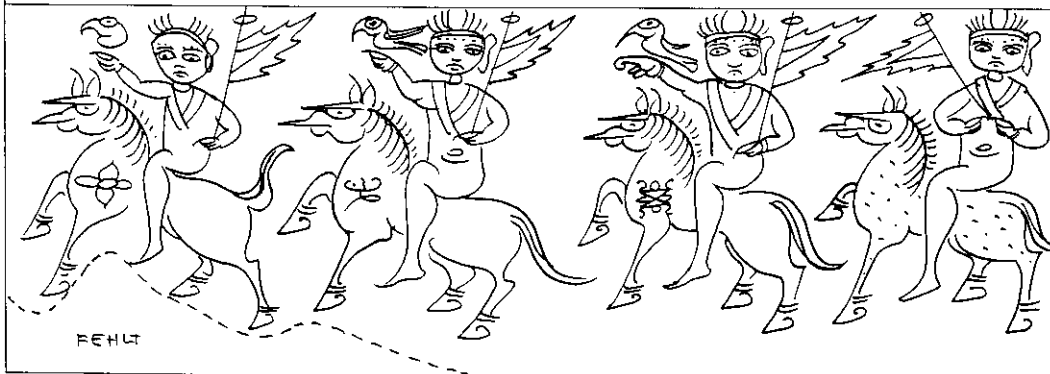

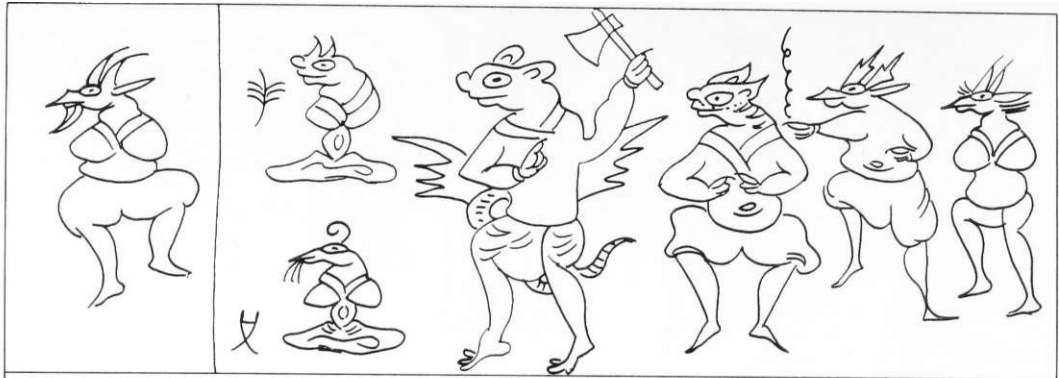

K. Or. 203 / R. 8198A. BLATT 7r-v

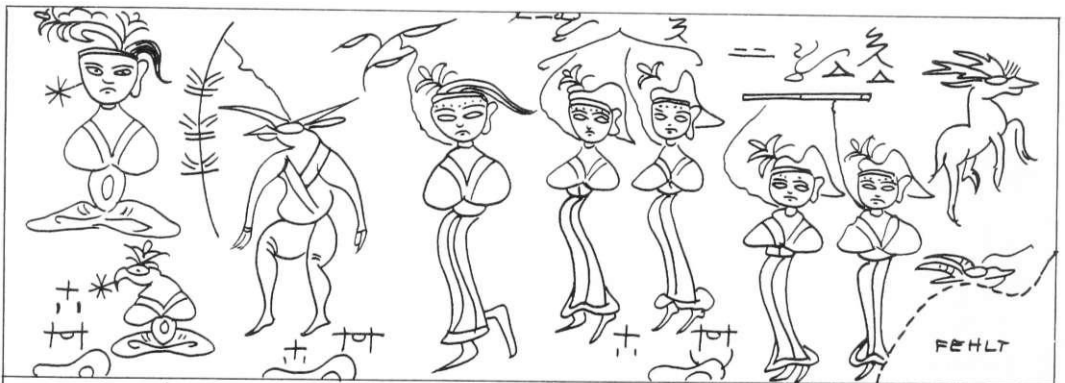

K. Or. 203 / R. 8198A. BLATT 8r-v

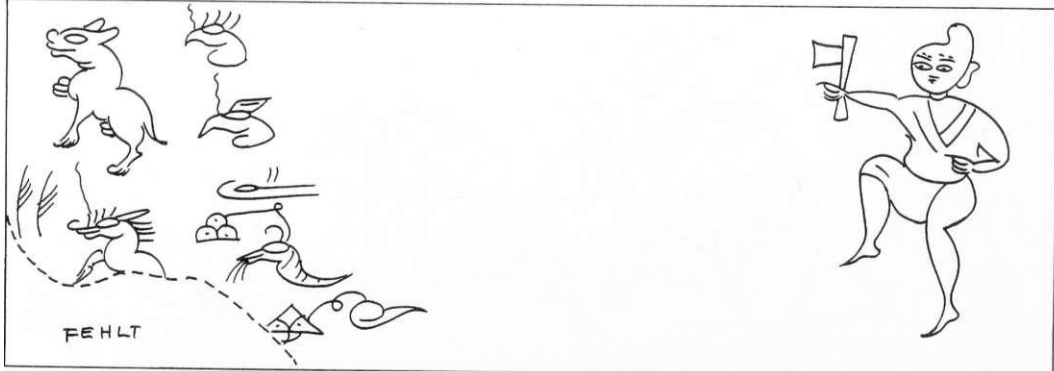

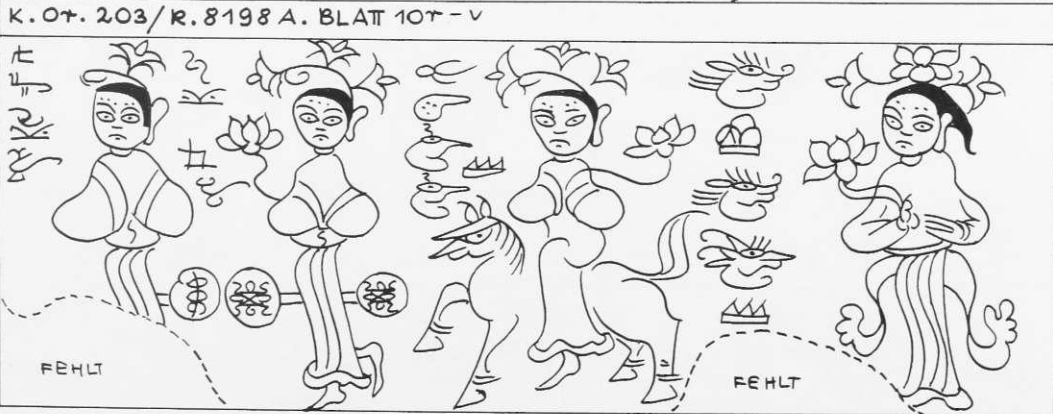
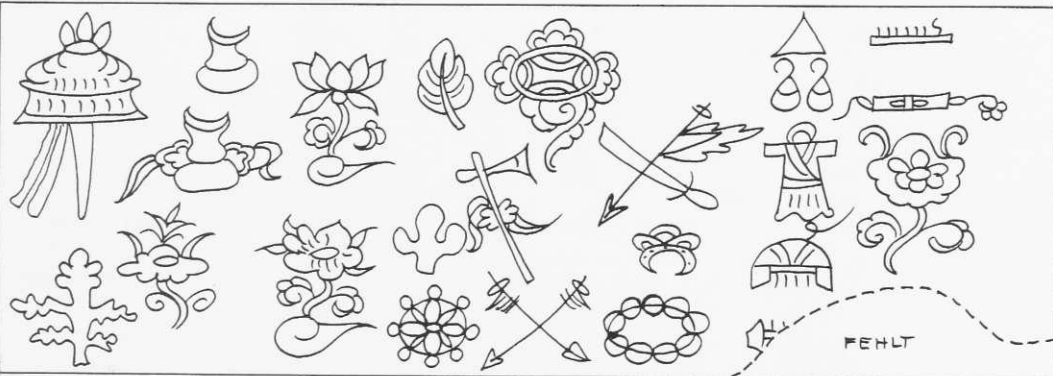
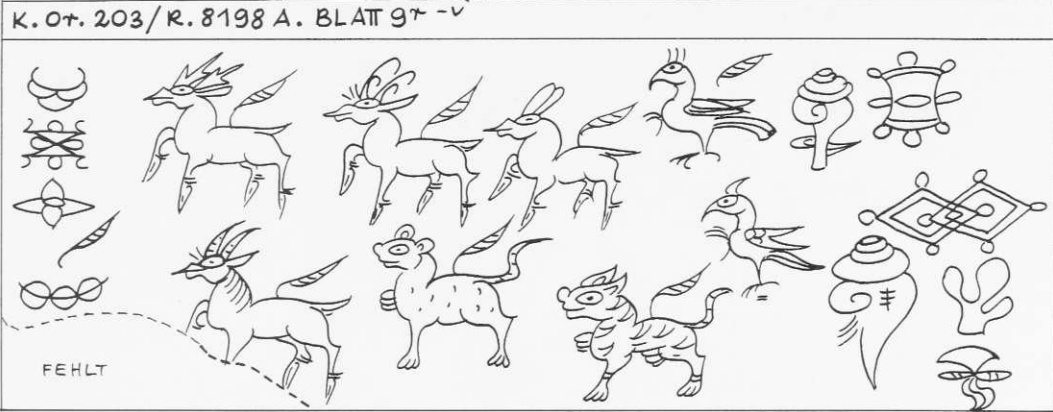



K.Chr-. 203/X. 8108 A. BLATT •H*--"

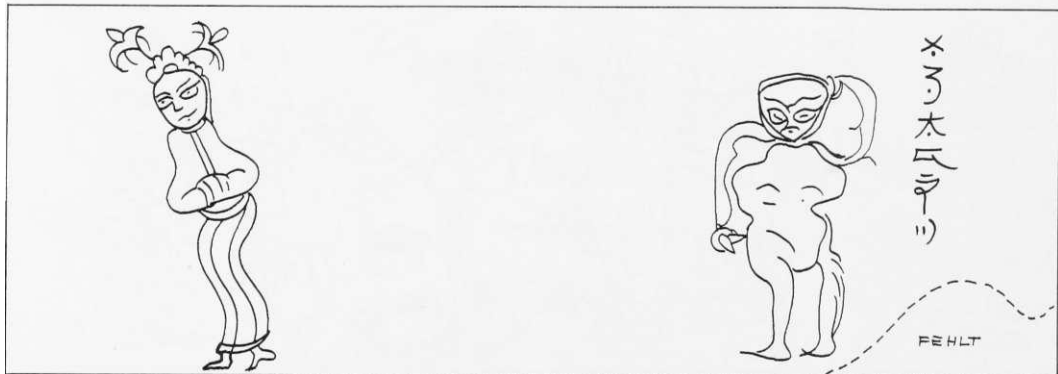

K.QTT». a o 3 / e . g i g g A . BLATT 12 / * - *

		-r
		┌
		= 6 .

^ m H H ce, ft. ^ IA, ^
7 g f- 4b ^ J



f >r ^ Si? ^ ^ 1 -

T7

FEHLT

7 V

K.Or.Z03/B.519EA. BLATT 13^

l

^ ^ " ^ ^ t ^ ^ ^ ^ ^ 3 5

ft ^ ^ ± 1r F^{o n q} 7



J & fr * J X c & _ *			
^ J>-l TT <f -V %R Lf ö			
K.O^ . & 03 / B . g 19 g A . BLATT 14"			
FEHLT N" S Q ^ ^ ^ ^ _ ^ ^ " ^ ^ ^ ^ *			



mil &^x

	^?	^
K.Of. R. 8^98 A. BLAT 15^ - ^		
	^ ^ ^ ^ ^ Bs f ^tr	

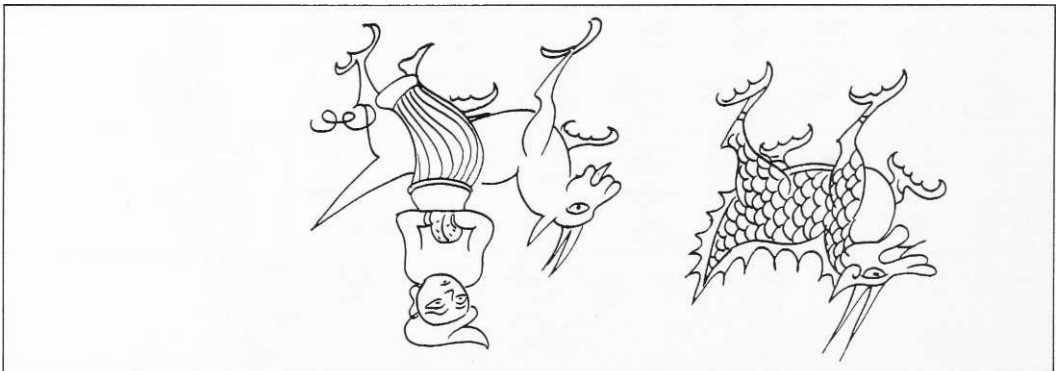

K.Ot. 203 / R. 8198 A. BLAT 16⁺ - v



3



g4

S5&

1

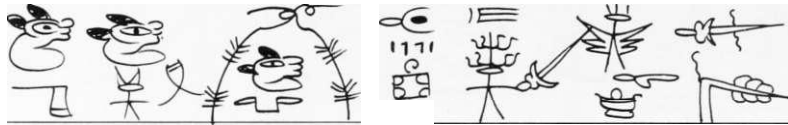

" 6 » it

HS.or. Sim. 5fefe/a. 112,5. 8LATT

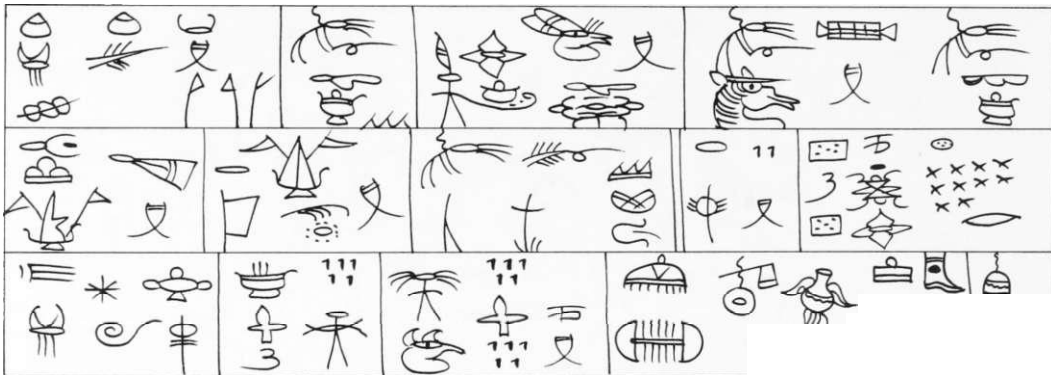

5^gf gl SJT, "		

HS-or. silTi. 5<@fe/R.. 1125- BLATTif^-v



H&OT-. sim. 5fofa/R., 112,5. 6LA1T 51--v

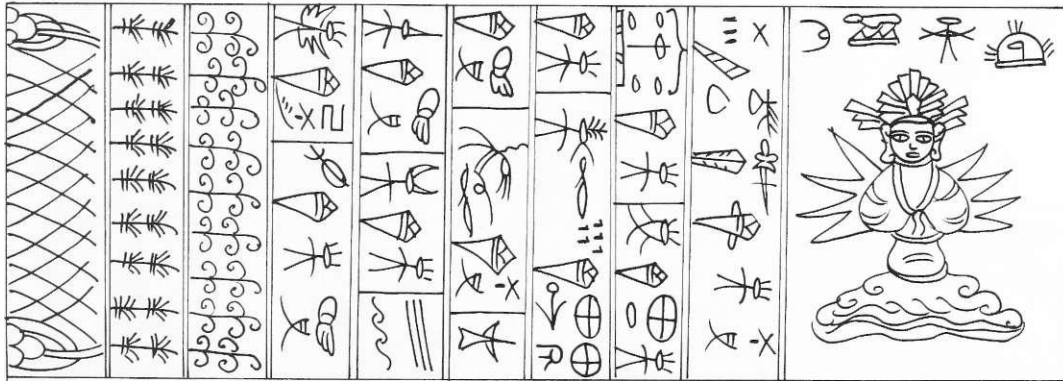

HS-OT-.sim. 5fc-b/B., na,s. BLATTE





Hs. Or. sim. 566/R. 1125. BLATT 7 r-v

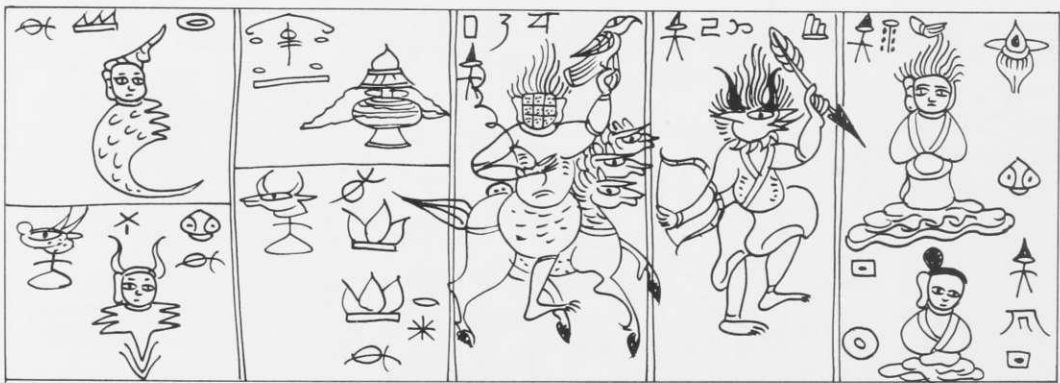
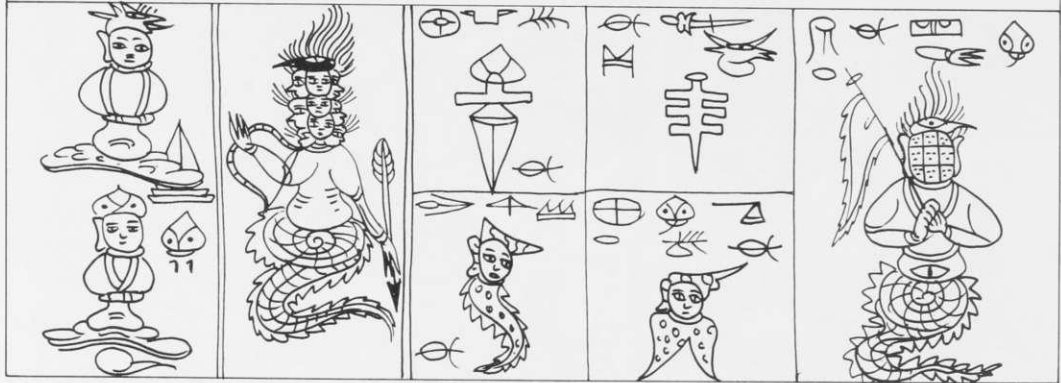

Hs. Or. sim. 566/R. 1125. BLATT 8 r-v

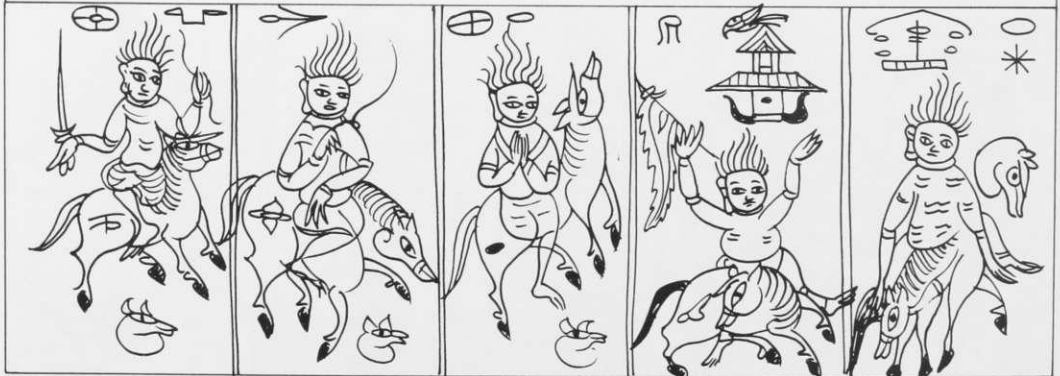

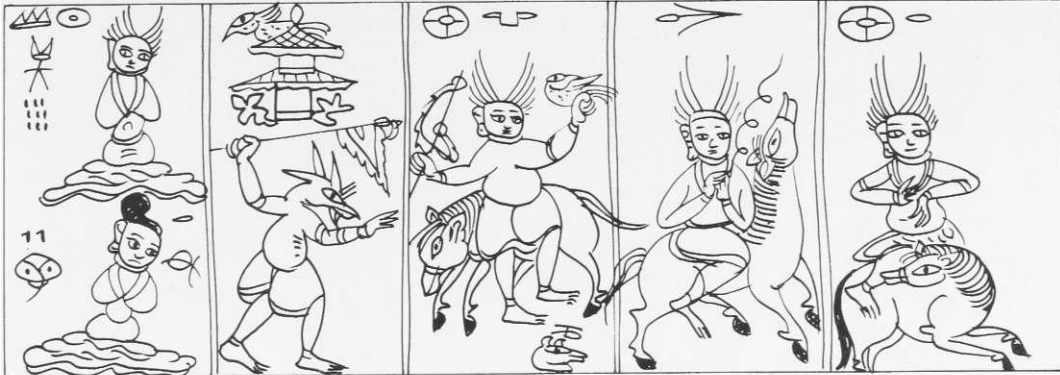

Hs. 07. sim. 566/R. 1125. BLATT 97-v



Hs. 07. sim. 566/R. 1125. BLATT 107-v





Hs. Or. sim. 566 / R. 1125. BLATT 11r-v

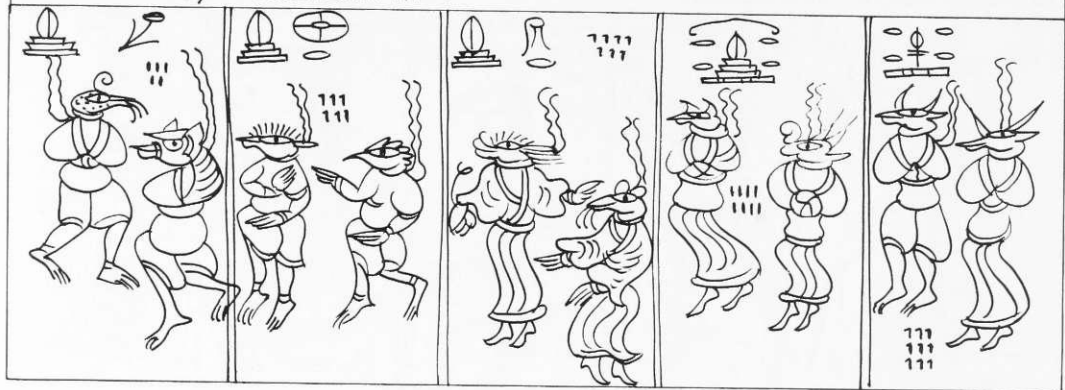

Hs. Or. bim. 5000 / R. -11^5. BLATT -1&r-v

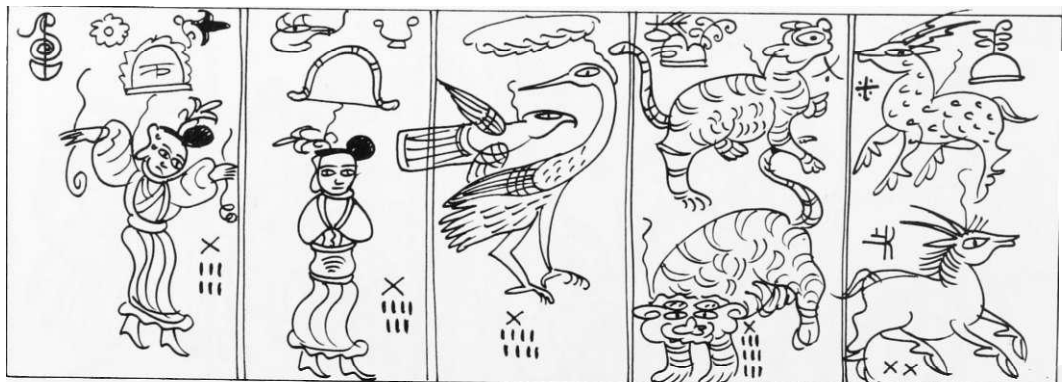

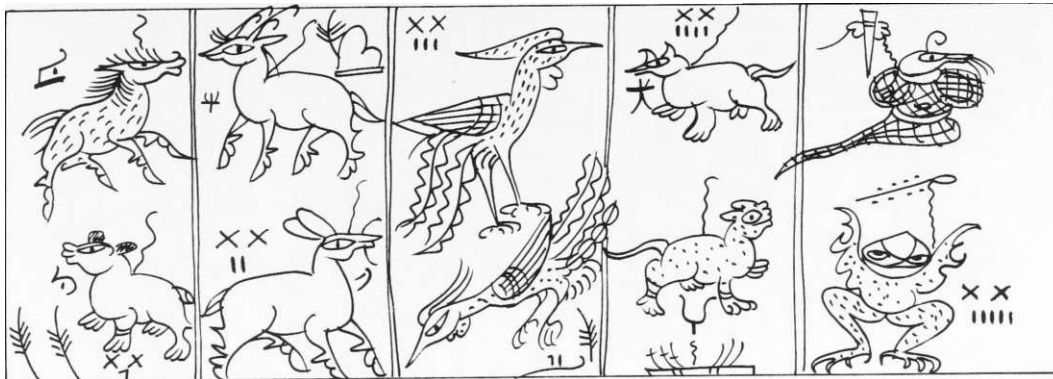

Hs. or. &im. gfafe/ß.. 112.5.BLATT ia^-v

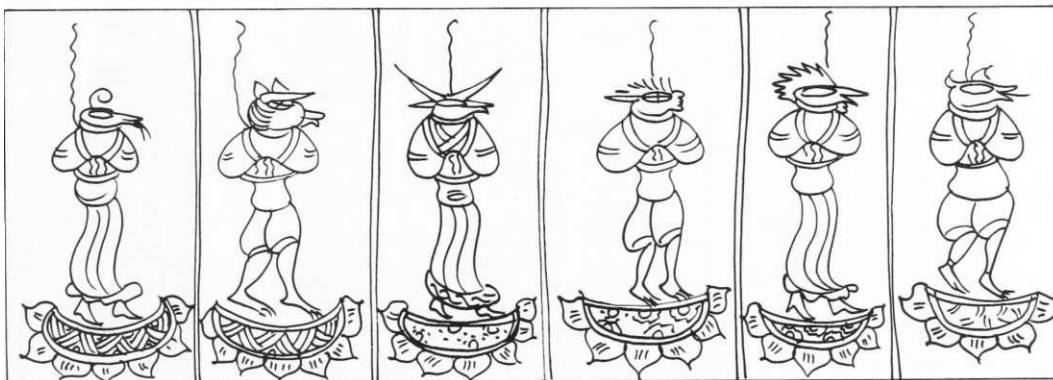
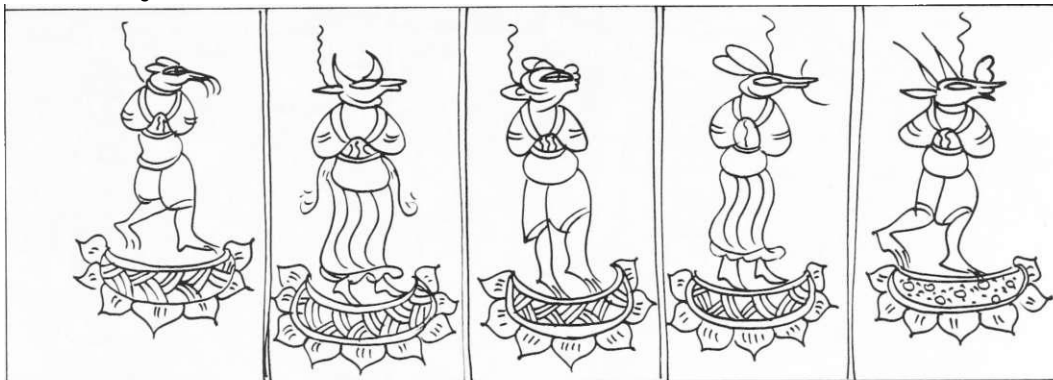

Hs-or.sim. 5bfe/R. -112.5. BLATT -14'''''





Hs. Or. sim. 566/R. 1125. BLAT 15^{r-v}

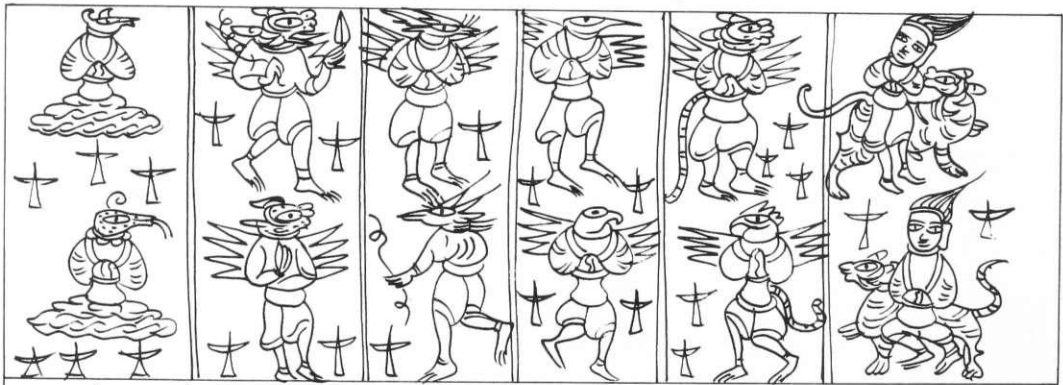
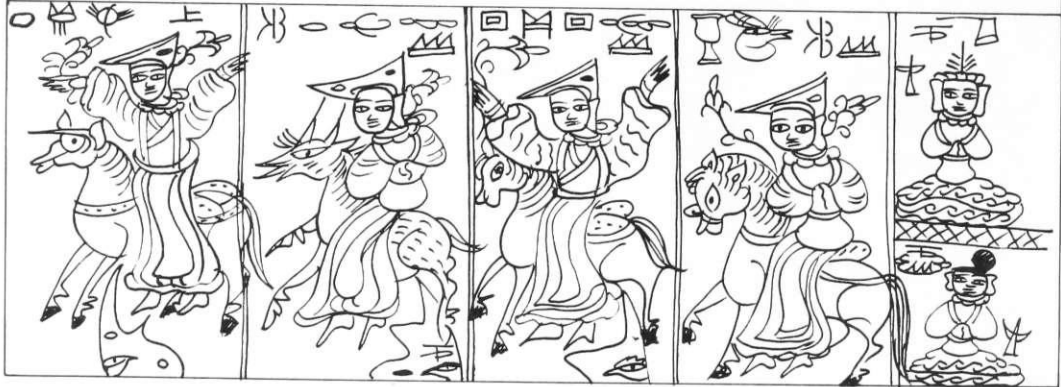

Hs. Or. sim. 566/R. 1125. BLAT 16^{r-v}

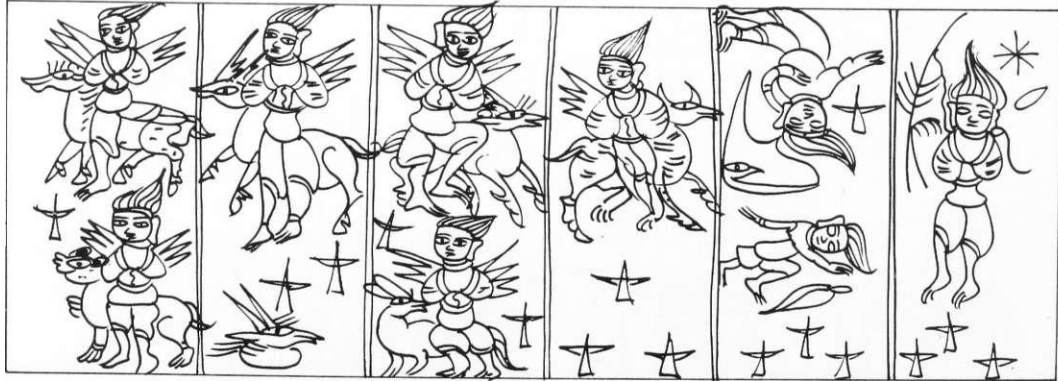



Hs. Or. sim. 566/R. 1125. BLAT 177-v

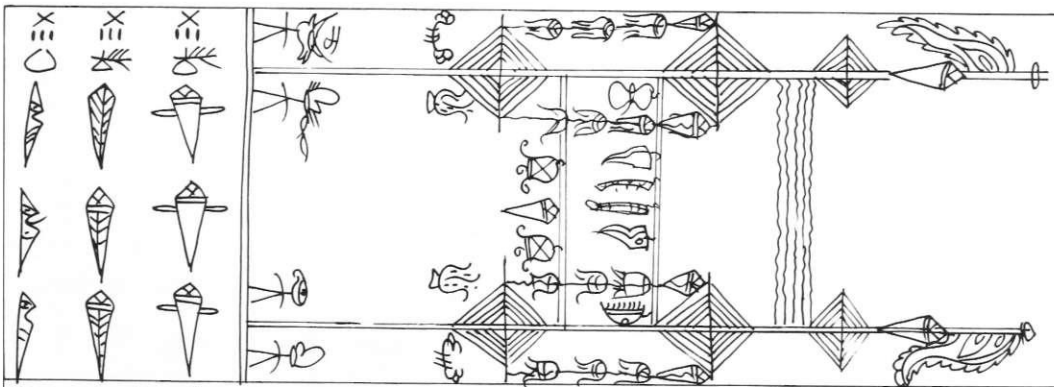
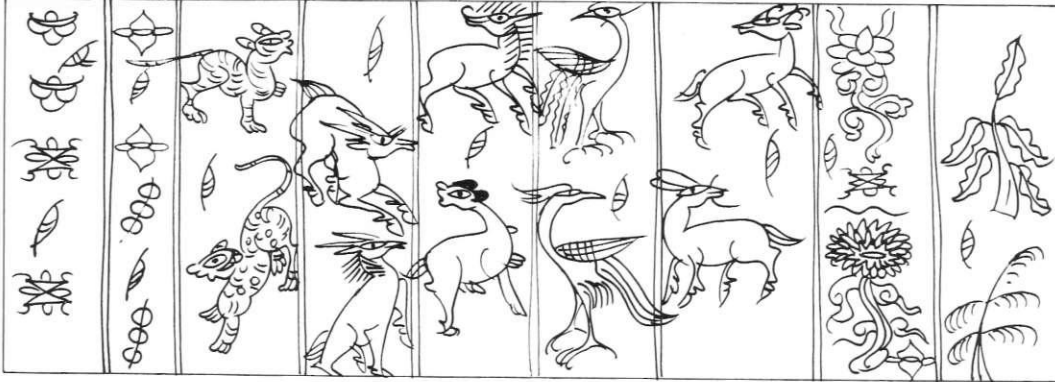

Hs. Or. sim. 566/R. 1125. BLAT 187-v

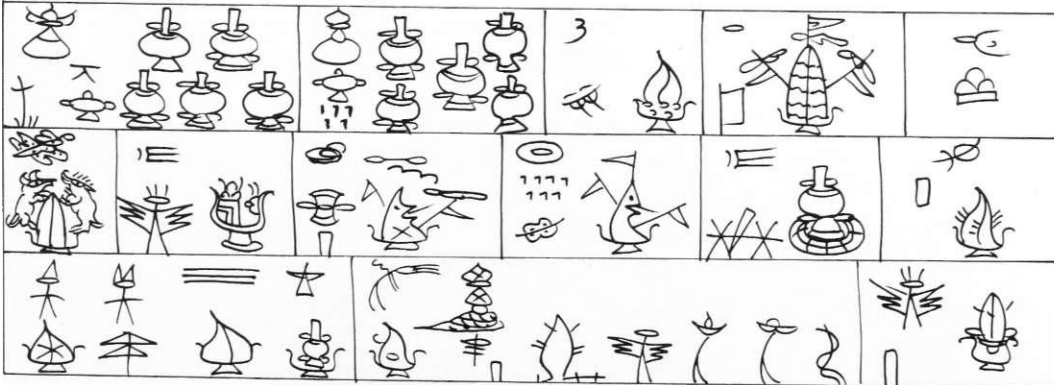

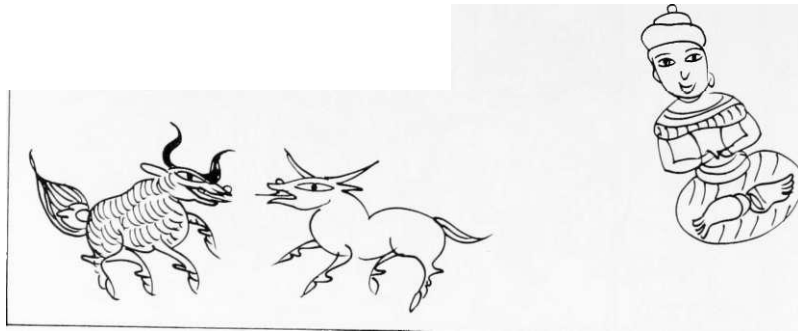

HS. OT\ Sim. 5bfe/B. -112.5. ÖLAIT19T-

*xüT, 9^0.

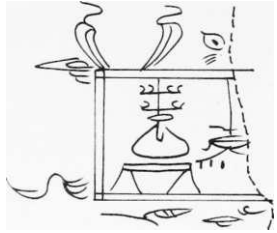

xiii, 9^ CK - Hs.orr-sim. 63o/ie. 3oa,o. Har la-llü.fe'ö,Z.hi-lv-dtü; Ssu-per 3fev-gyi tu,- Qfeo ö.

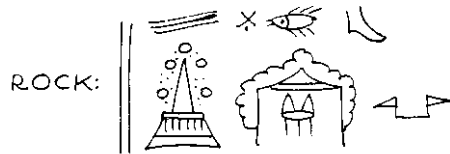

ZFL\

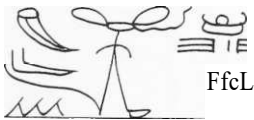

FfcL



SIE'

rlL

X

1



Hs.OT-.sim. <b30/B. 302,0.BLATT^t-

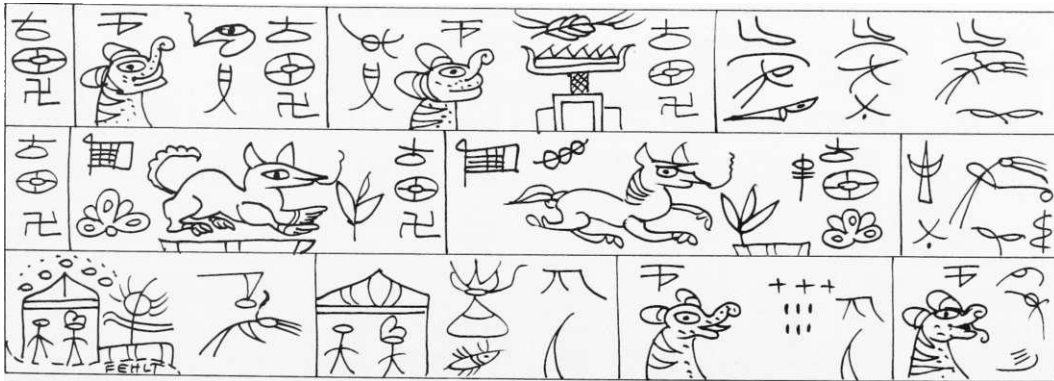

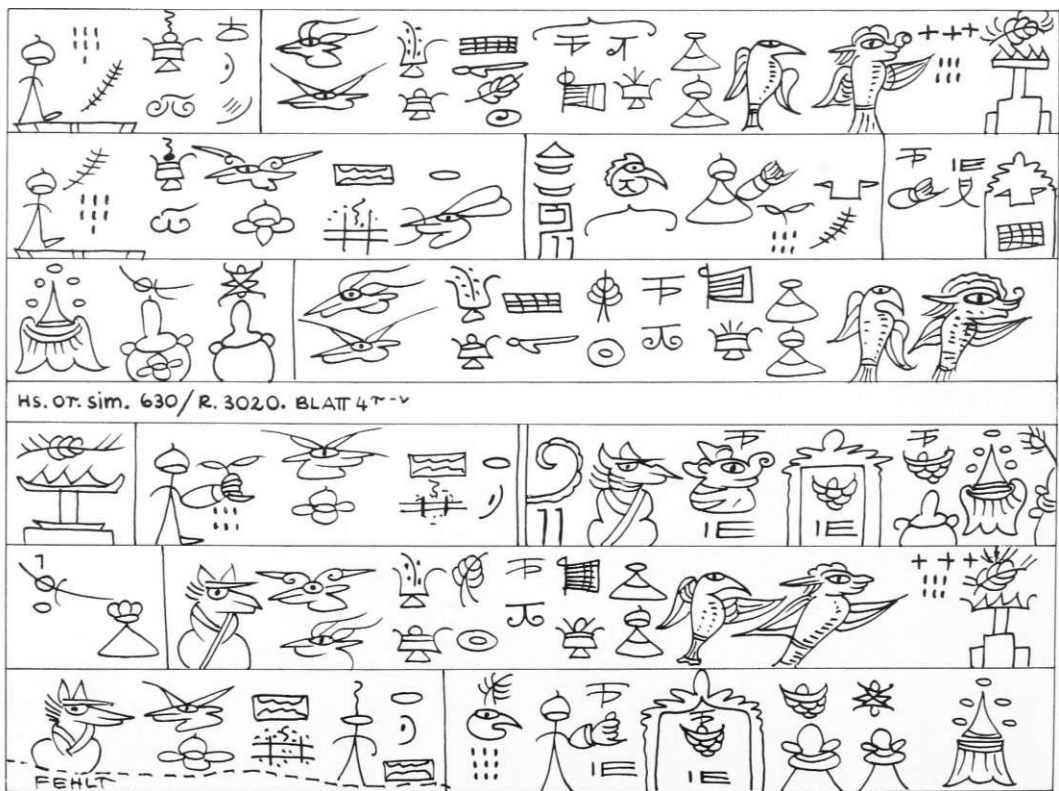
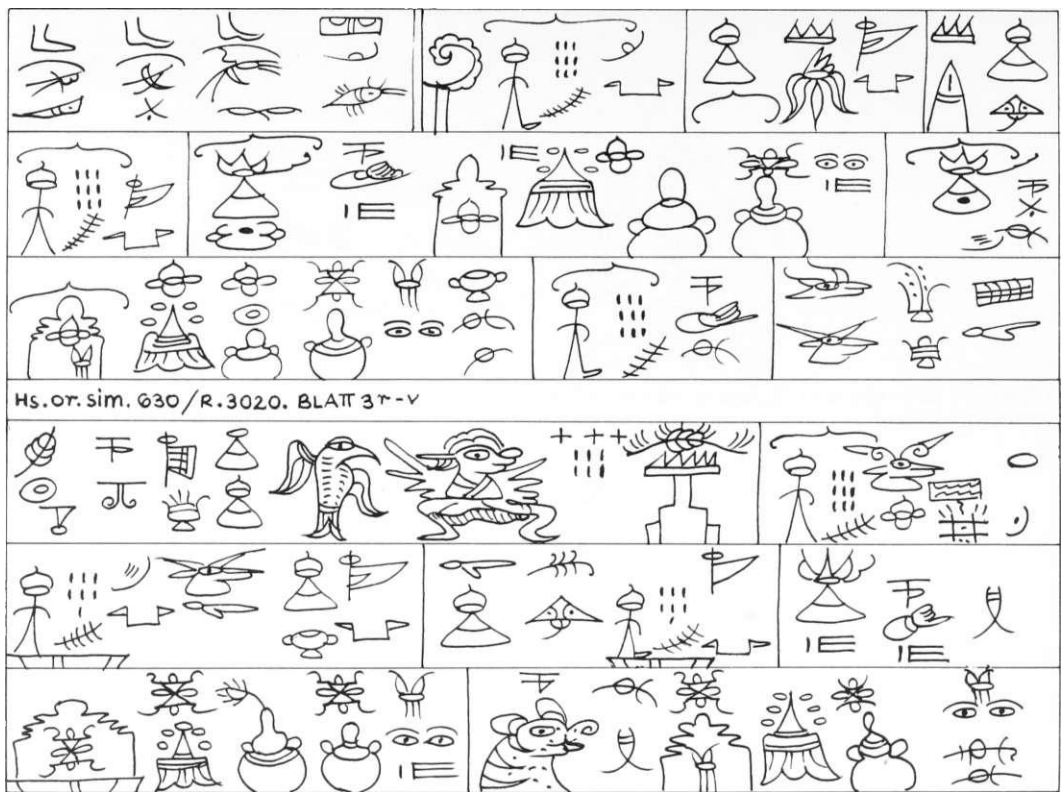

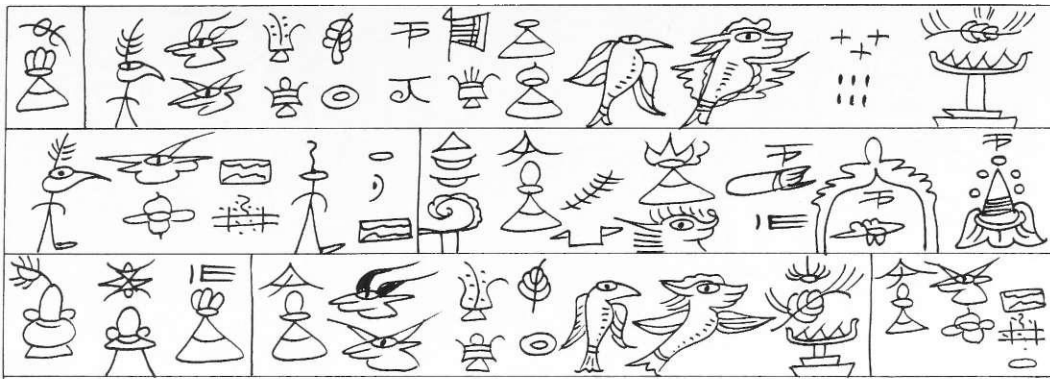

HS. OT. sim. 630/R. 3020. BLATT 5r-v

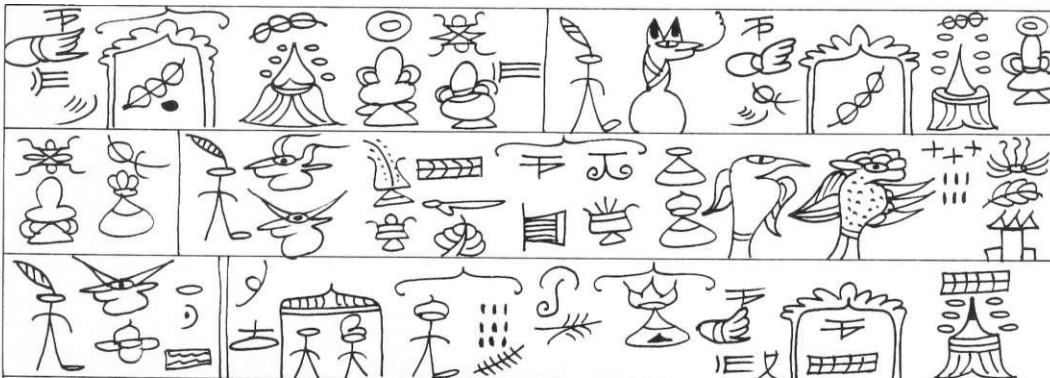
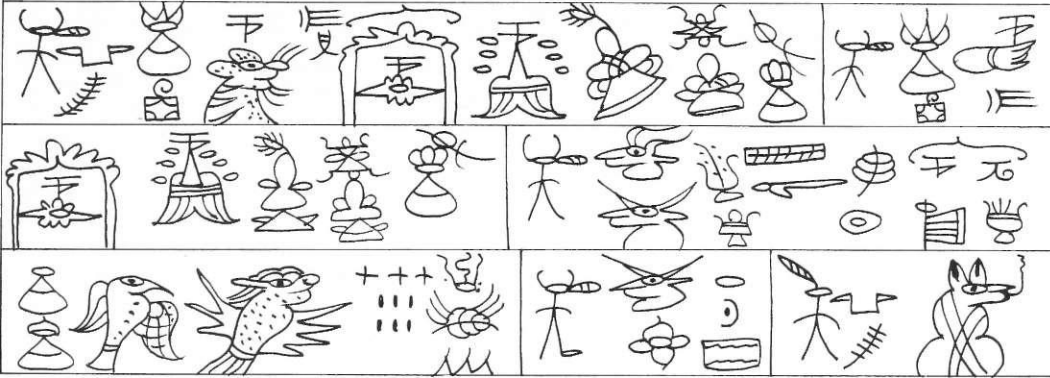

HS. OT. sim. 630/R. 3020. BLATT 6r-v

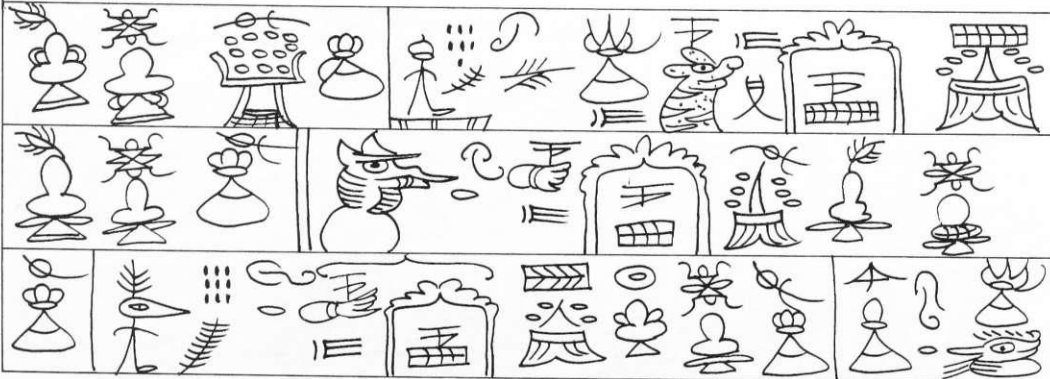

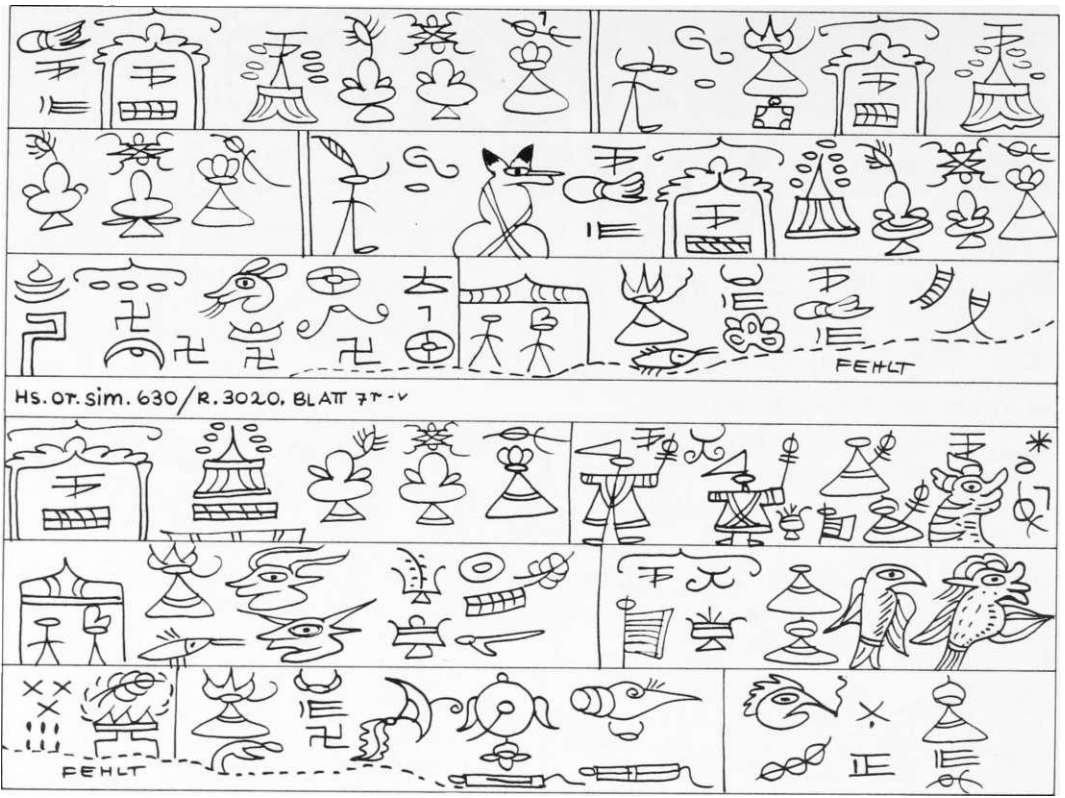

Hs. Or. sim. 630/R. 3020. BLATT 73-v



^ & 4 ^

^ = ff ^

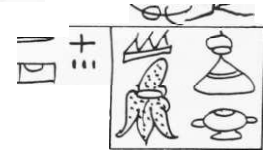

Hs. or. sim. foäo/B.302.0. BLATT a'''-'

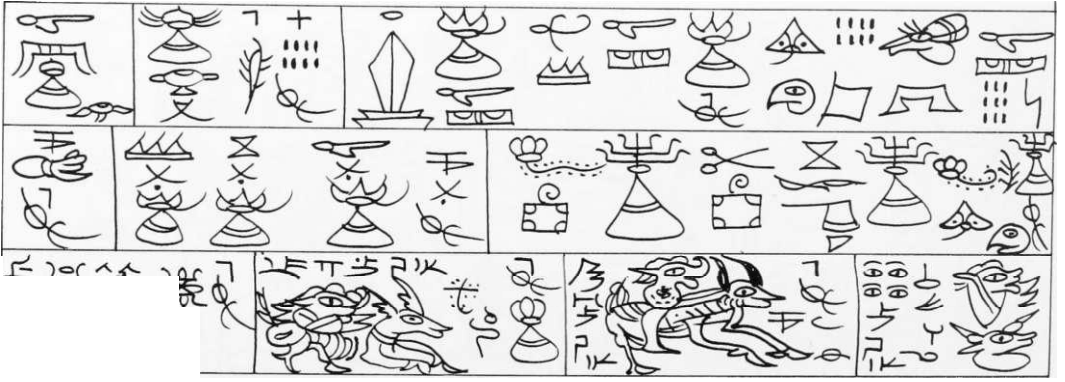

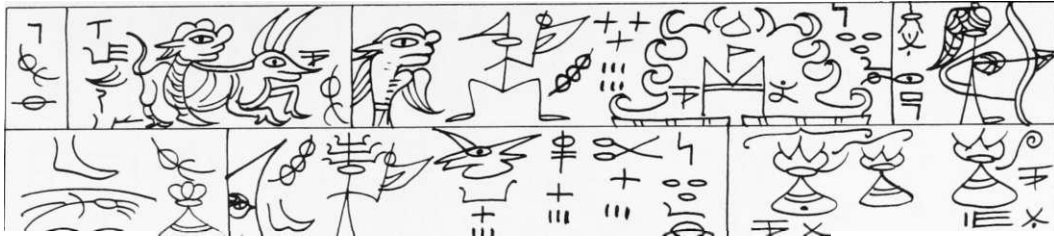

	§ 5 *			
--	-------	--	--	--

Hs. or.sim. b3o/ft. 3020. 6LATr9T--

⋮ ? (^ X)«C	/D<=<
	ff	fr* wF*		
⋮ c			⋮	

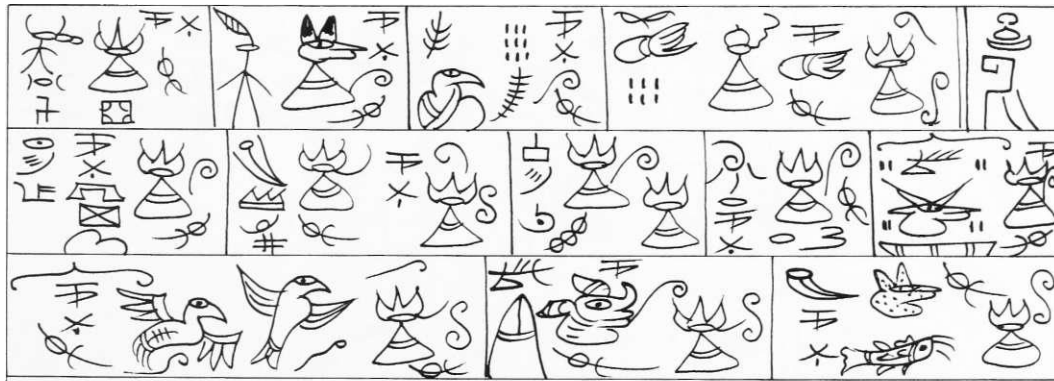

Hs. or. sim. 630/R.3020. BLATT 10T-v

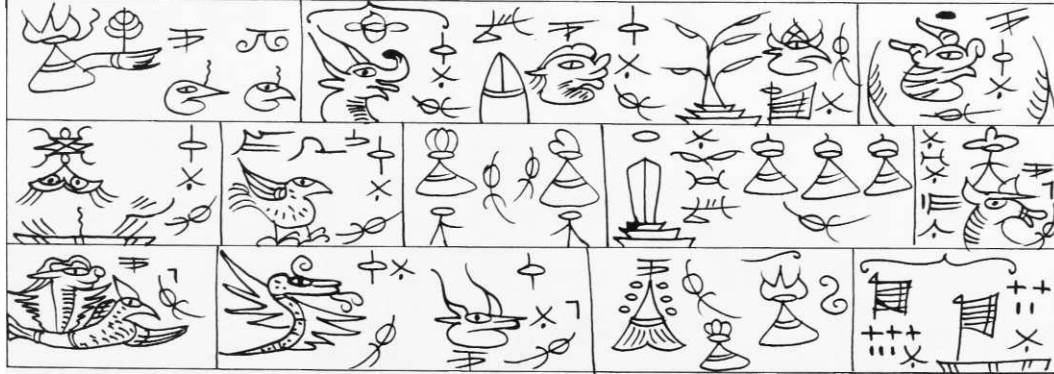

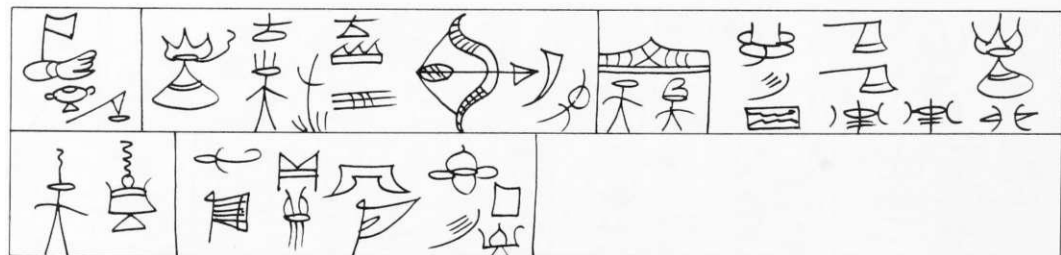
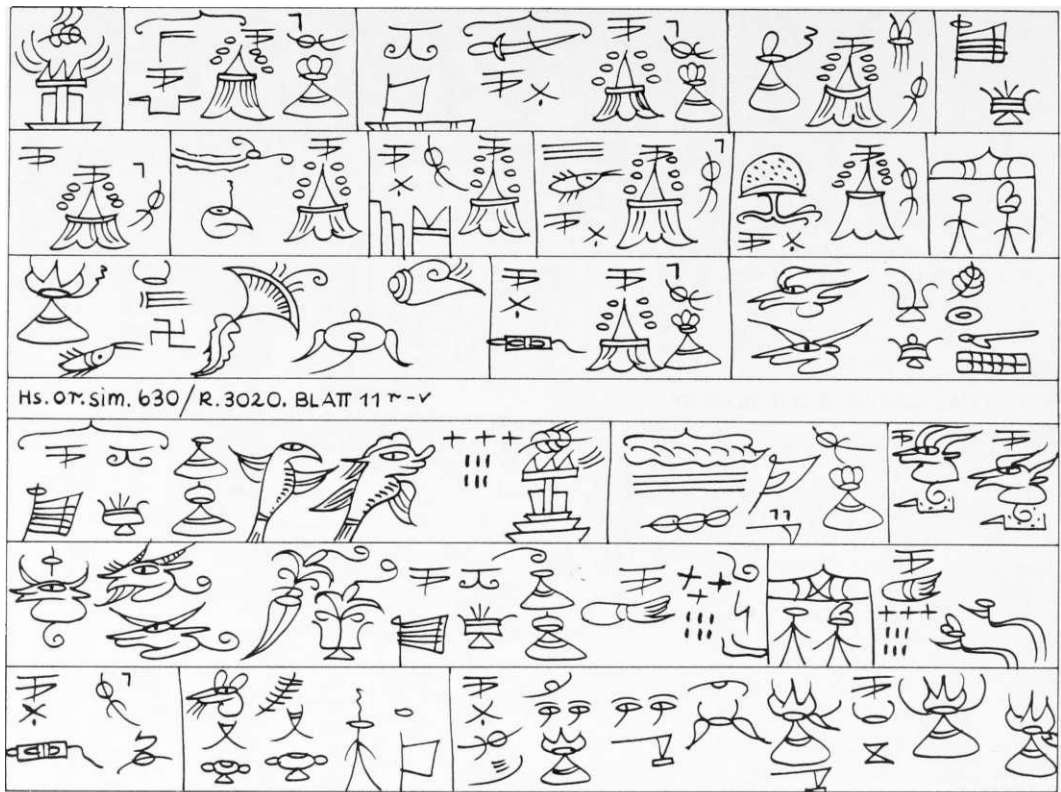

Hs. Or. Sim. fc30/B.302.0. BLATT IX ^ - v



Xiil, 9^ et, 1 - Hs.Or.-1S8G/»e.31^3. HcLr la-Uuko. G»ko o;Ssä-d do ts kj Mb'a-midshl; P'u-lasscau. BLATT 1T--v		

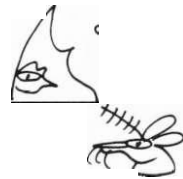
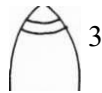

a>=

Hs. OTT. 1386/ft. 31^3. BLAT 2f



1 1

' r °

4 M



ll
o

HS.OT. 1386/B. 3143. BLA7T3>

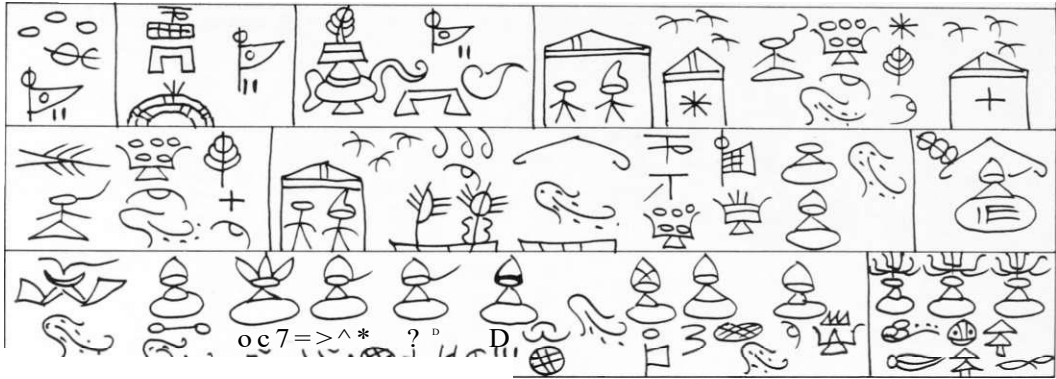

^ ^ ^ ^ ^ ^ ^ ^ ^ ^ ^ ^		
	[^] jβ	LIT ^
HS. O^ 13gfc/fc. 3143. BLATT 4 ^ ^ ^		
© 1 ^	^	
" r-n-i-i		
tu	€ ^ c ° = f ^	
Till=1	V-	<8b /k





o 05=
 ◊ III
 •

« 5 ⁱⁱⁱ i(i) TT ^











3 ^

HS.O?-. ^ S k / * . 3143. BLATTS ^



Mil Y
MM

to Y

«iii
I KI
i b .







0 ^

TTTT

	^ 8		
ö r-r-n=f			

Hs.O>. -13S&/R.3143. BLATTE

r n m / ^

Ffci



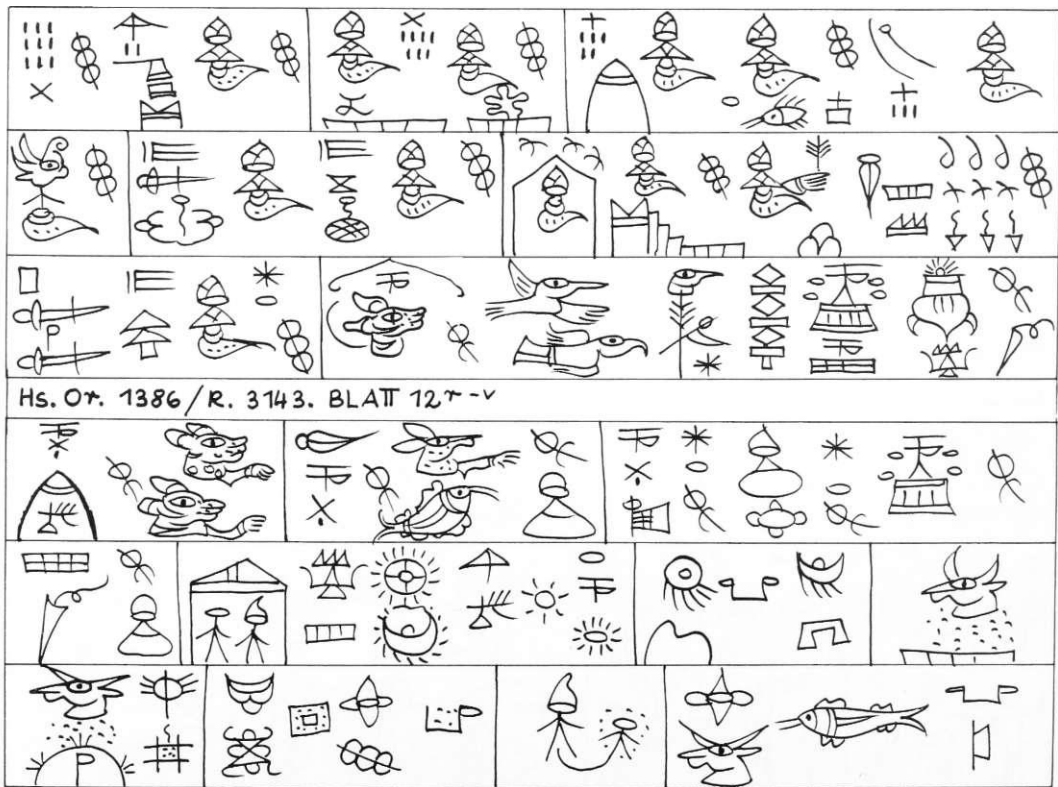
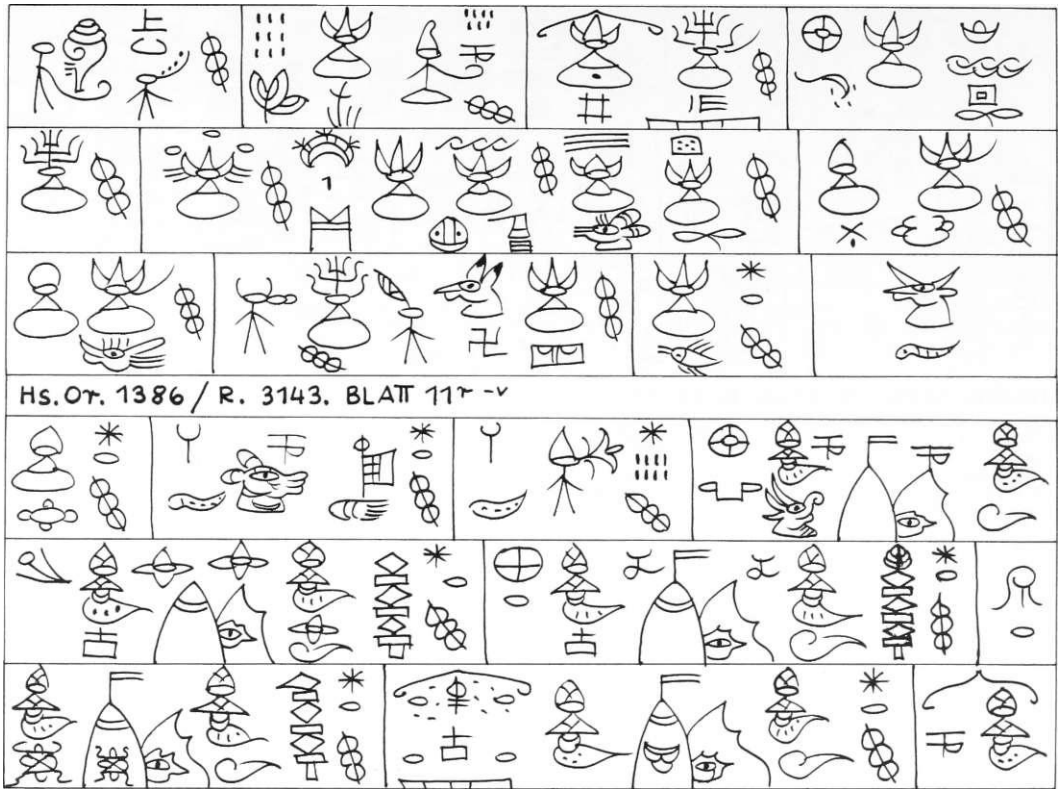

\% - % • • • 4 4 -	

Hs.Or. 3143. BLATT 1 3 ^

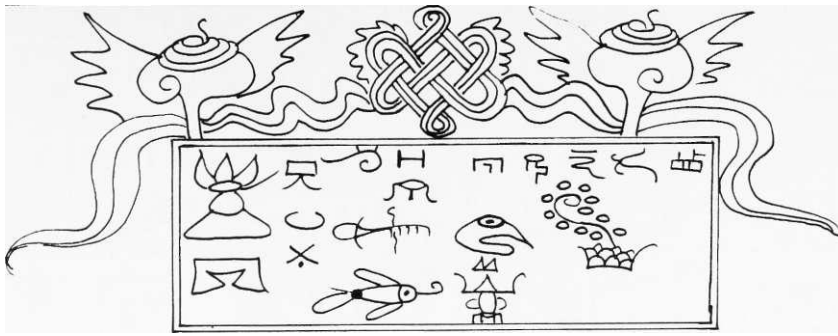

XIÜ: 9 ^ a / j - K.Or. Z31/K.gZ51. Dto k?6 Har k'ö.Gkoo; PU-lassato; Mb V ml dshi.

BLATT 1*--*

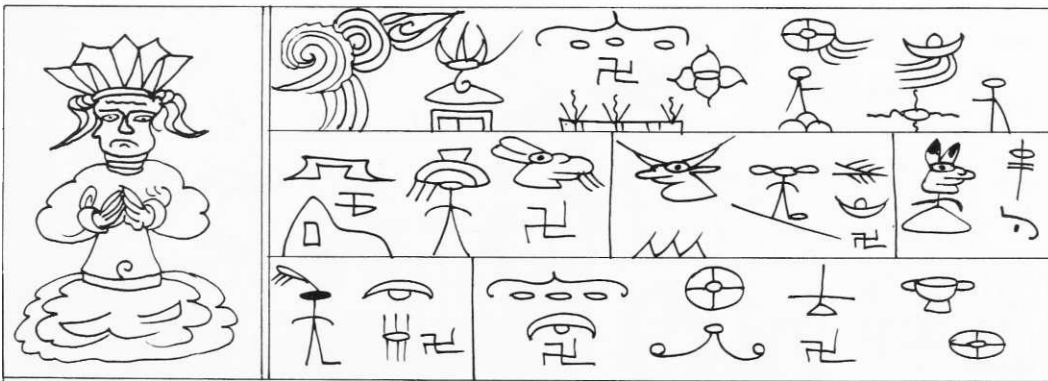
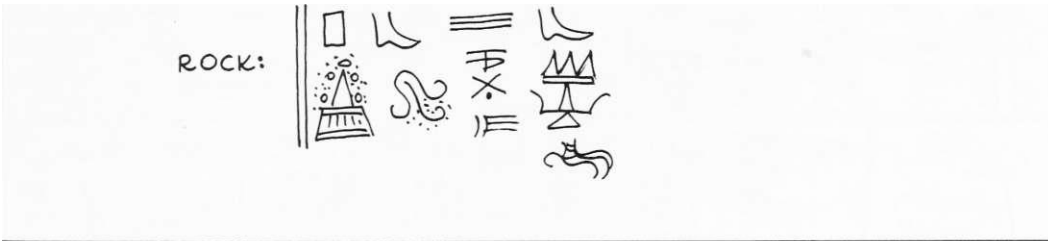

K.Or. 231/le. \$2,51. BLATT

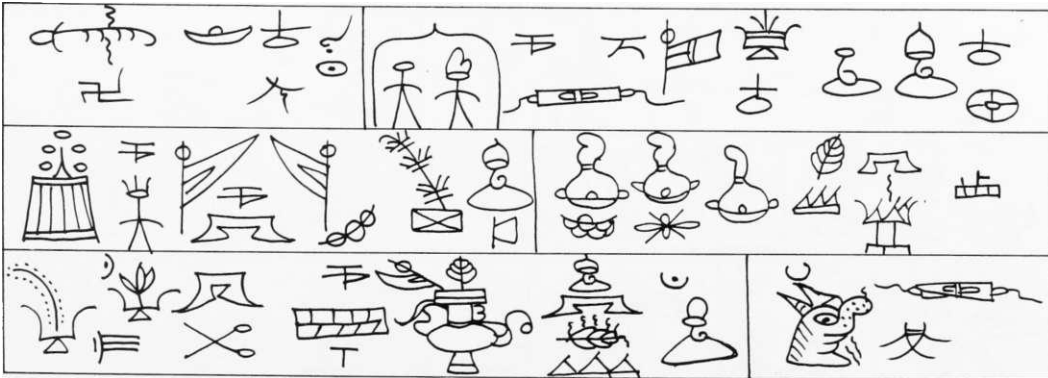

CD . .		
(dä&c'b •f~i~&r		
K.Or. 2,31/fc. 82,51. BLATT 9 ^~		
		- s i p to T" LB
		o > rn-rf-m

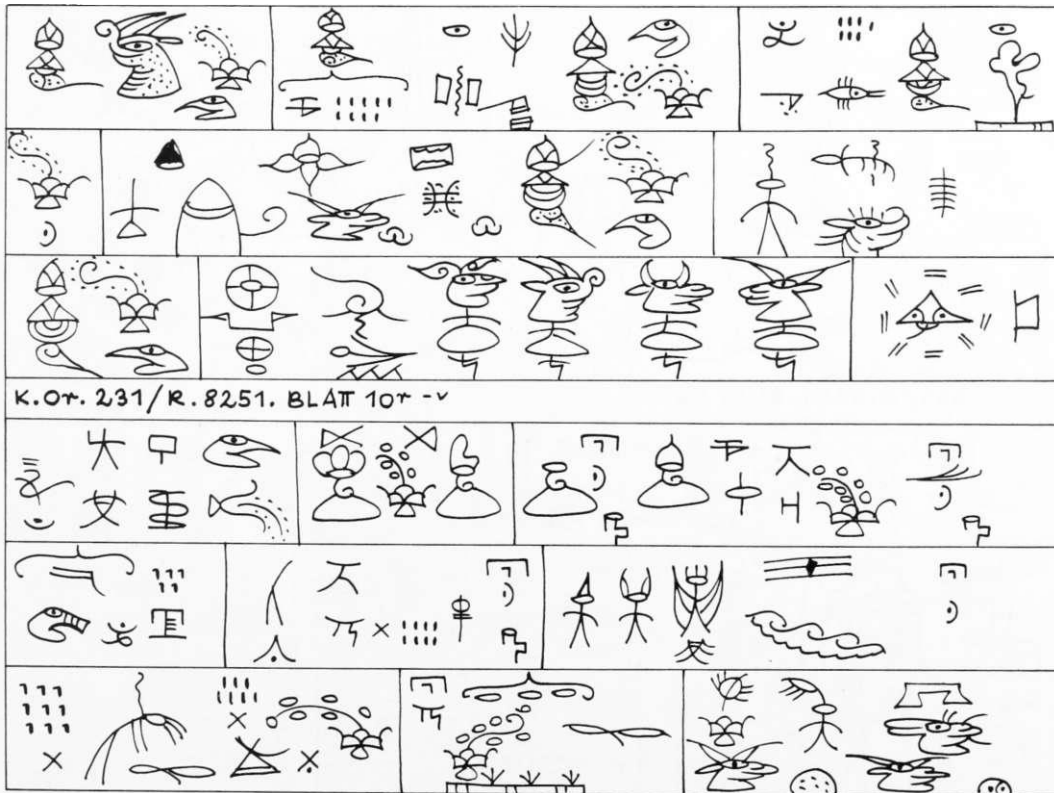

K.Or. 231/R. 8251. BLATT 10* ~v

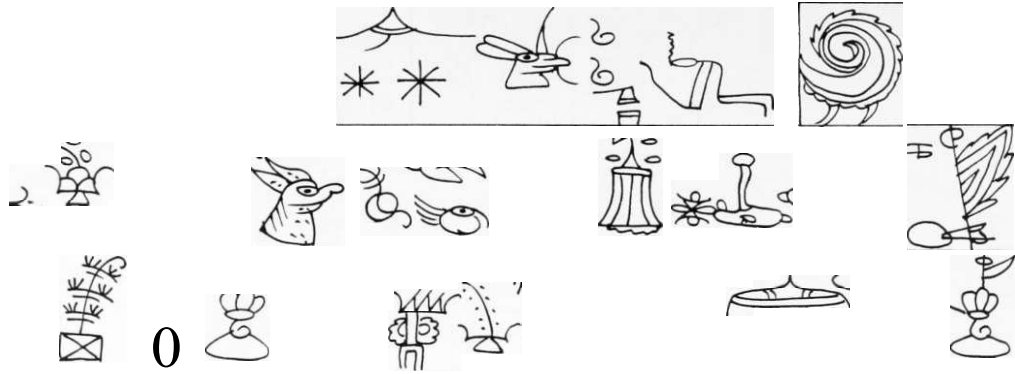

K.Ot. 82,51. BLATT 11''^~

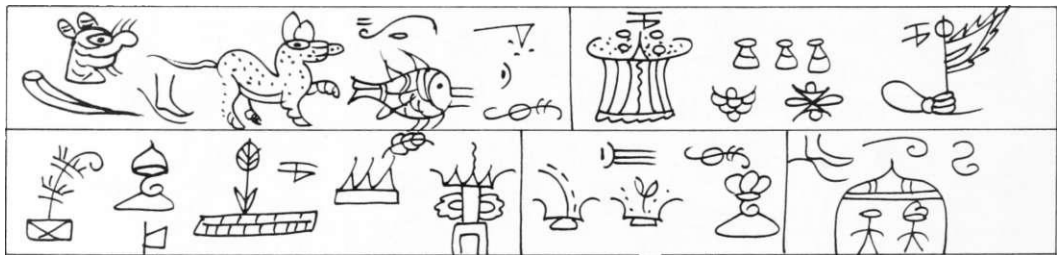

— 55 J® Ä / 7 Lk cb Pro
  2>

K.Ot-, 2/31 / B . 82.51. BUAT 12, ^

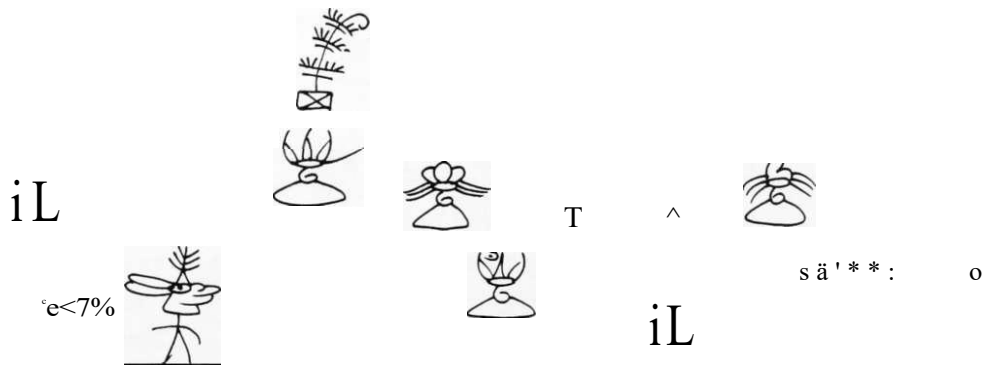

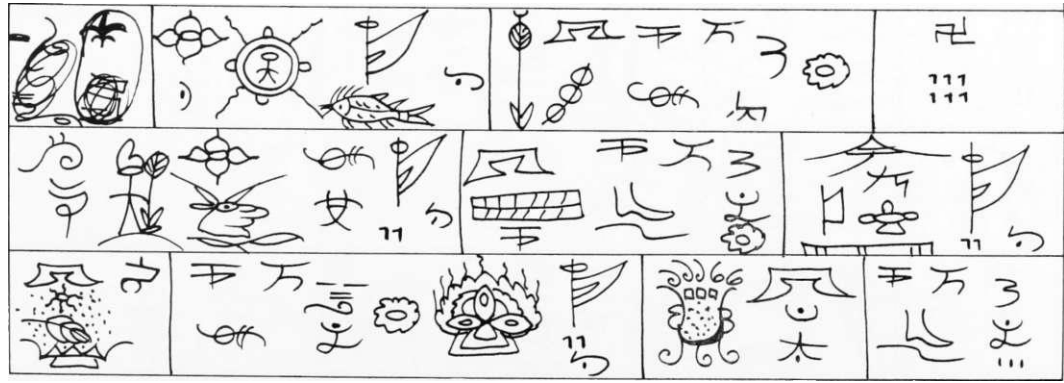
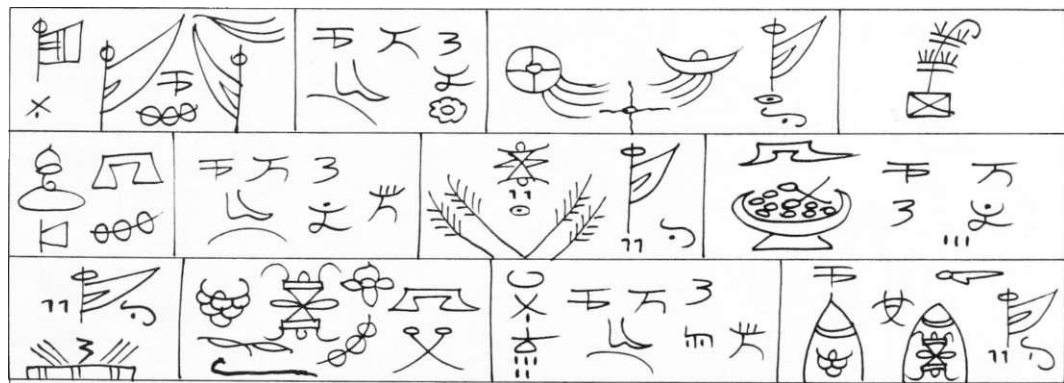
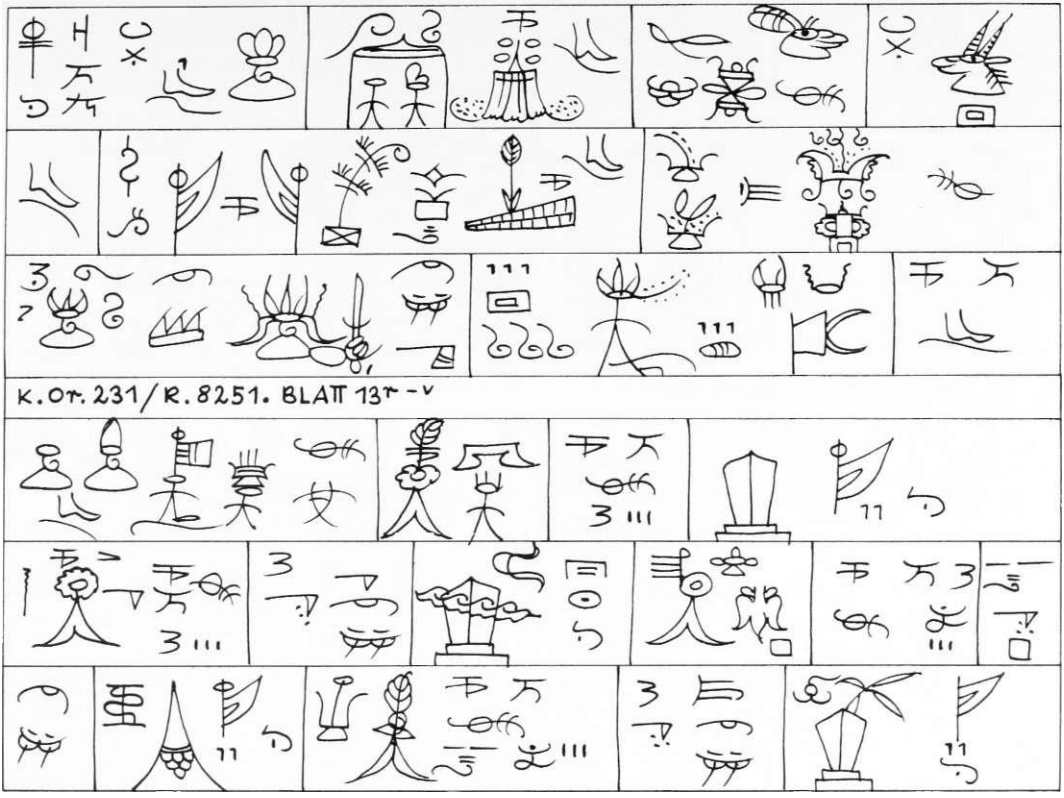

'Ml	K	° <5=S. a x	serf, ^ ^
(n)			
3		TP	
K. Or. 231 /ie. 8251. BLATT 15 ^{^ -v}			
		& 6	^ i E TO- ^
		^	
⌘C —			

K. Or. 231 / R. 8251. BLATT 16 ^{+ -v}				

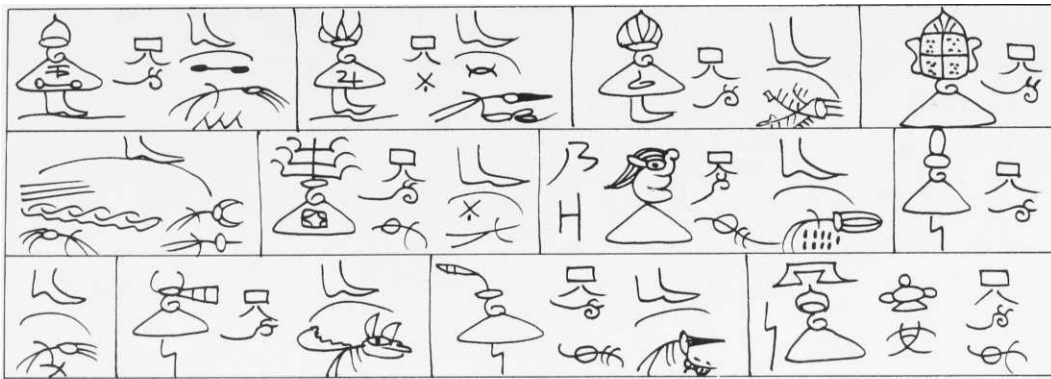

K.Ot. 231/R. 8251. BLATT 17r-v

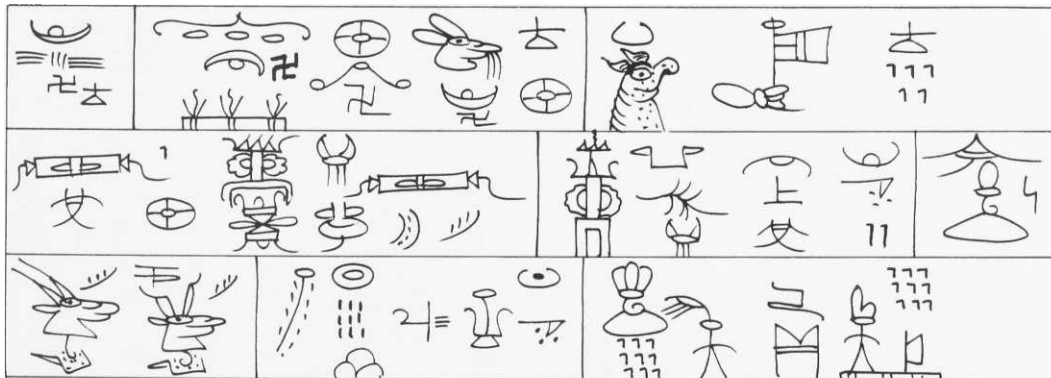
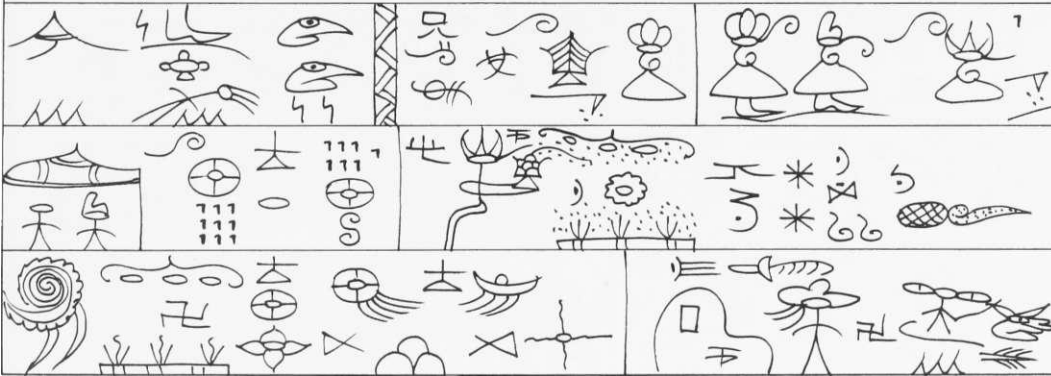

K.Ot. 231/R. 8251. BLATT 18r-v

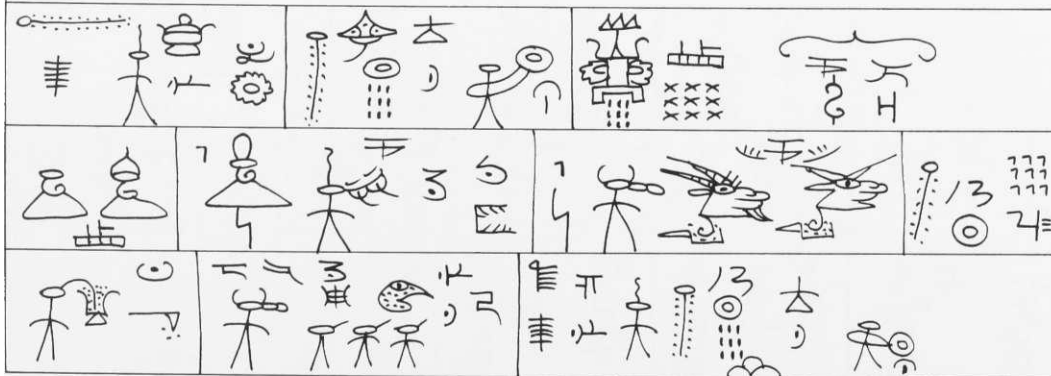

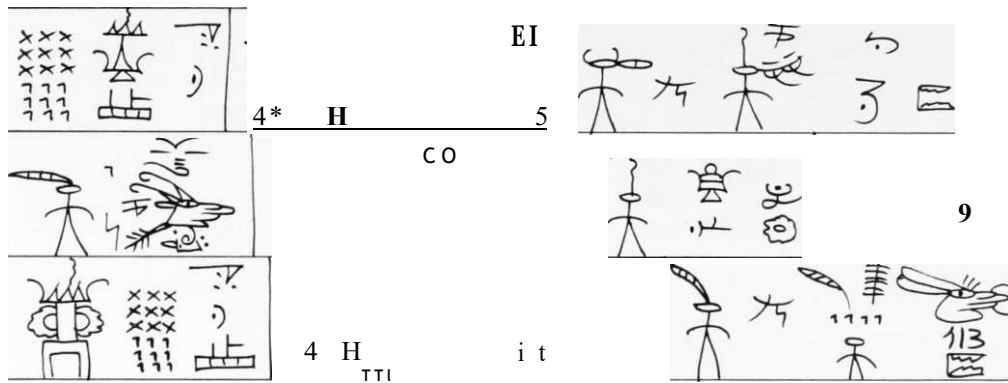

K.OT. / e. 8zsi. BLATI9

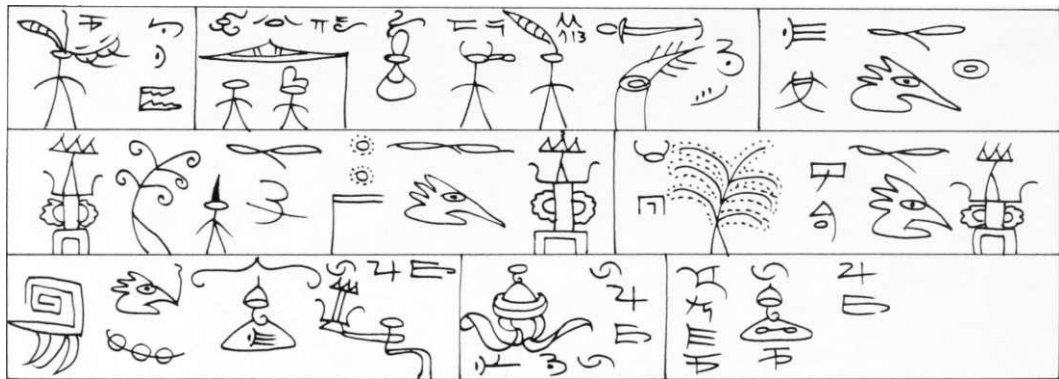

		- &		&			
ü I	s						
		-a, %			1		
K.O-r. 231/K.8251. BLATT 20^ ~							
			>	i	1 fei-	en ^r-	
			I	X	t		
I S T		>	^	^	← o ' 2f,	%sr> 24	? ?

$\frac{1}{x}$ 14			³ t .
K.Or. 2,2.1/B. 52,51. BLATT 2/1 T--v			
		E I ^ B>	

K.Or. 2/31/B. 82,51. BLATT 22,



Jb

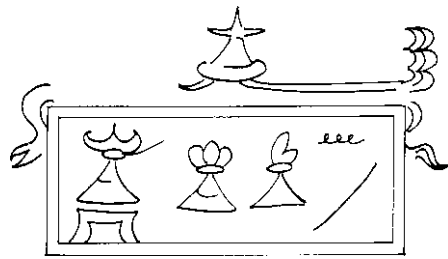

xm, 9?, CL, 2/-Hs.Or. Soo/β. ffiOfcB. Ha> ta-llü ko. Ehl-dtü^ko-ö; Ndu, SsächW. HAAT

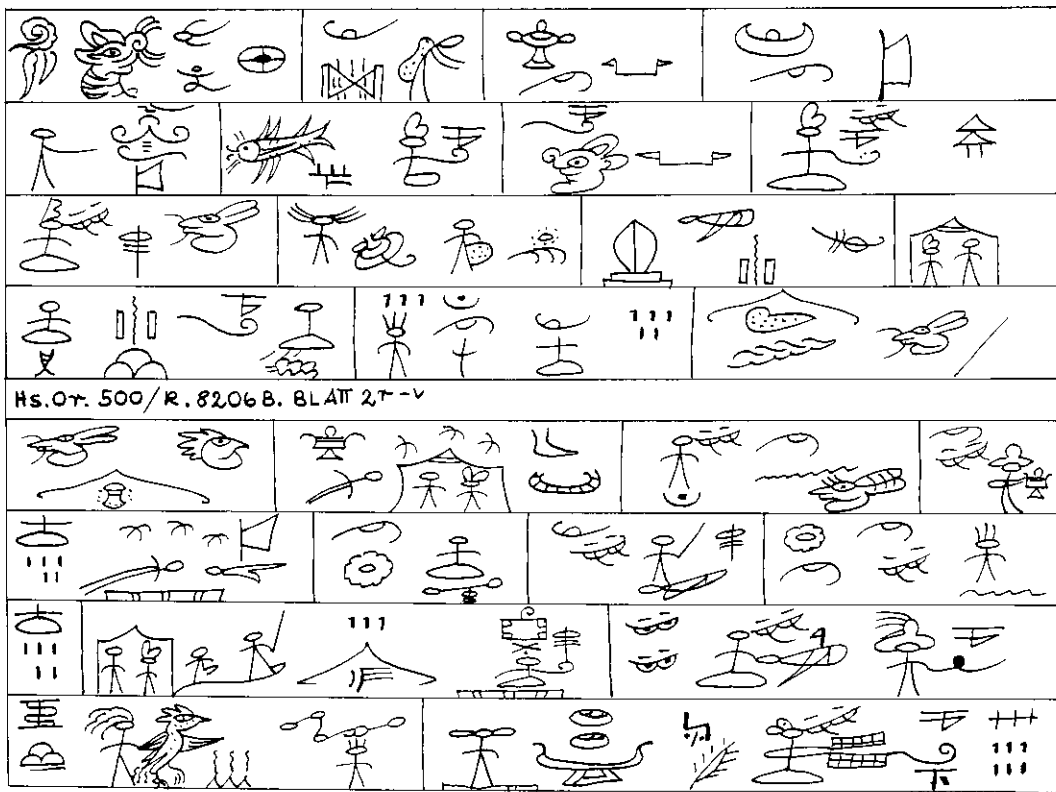
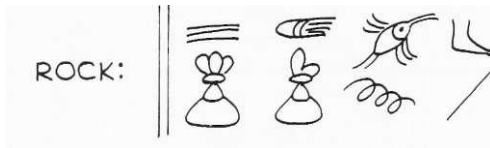

c — / f T ^ T > ^ Ä ,i?		
HS. Or. 500/ft. 82,0b B. BLATS ^ - ^		
		~——XXX

	^ / f ^ m	AAA) / < "
HS. Or. 500 / R. ÄLOfa B. BLATT fe> ~ ^		
	^> i iv ii—77-7 »»'	*_
<i>f</i> * g a s , & 1 ^s		

		M C	
^ i n	/ I H M I I)	AA> >> ^ ^ (O ^ ^) i i I I »	
HS. Or. 500 / . 820b B. BLATT "			
^ j j ^ AAA AAA	K 3 B ^ AAA A ¥ 7		
	r i l		S

^ — < - <23> ^ R ? ^ - * = - > * r			
^ G F	V	^ I	
Hs. OTS 500 / e. 82/Ofo B. BLATT £ > ~			
		V' \\ 4 1- TT = 7	
xxx ^ AAA ' . .			

¥	- B . - 3	*? f ii
HS. Of. 500/B.8a0foB. BLATT 91- ""		
		% ^ > ^ CS) - s >
01 ^		<öS> ^ > \
r-r-i-r-r-r-r-j		I S - ©

	6 0 9 ^	^
		\$ >:
HS. OT. 500/ ft. 8X, Oh 6. BLATT-10>-^		
		r

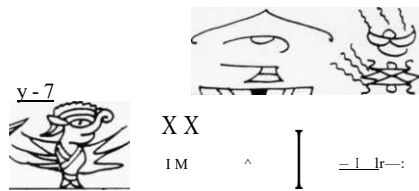

y.

«t—p

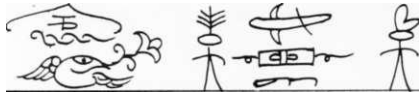

ll
- Tr - i e

HS. Or. 500/R.. 8ZOb&. BLATT



4 -
4 -



5 I t ^ 1 ^ £ r 5 " F "

T ^ 7 = -
H

r7 H

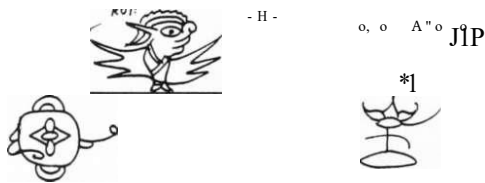

FE

v-Q EEE3

HS.Or. 500/R.. 5ZObB. BLATT 12'

L-

i

Cgi?

1 1

xTij, 9?, a,2,- Hs.Or. 548/B. 8250. Hclr la-lux ko.2-hL-d.tu.9ko-ö;Ndit Ssäch'ou. shw.

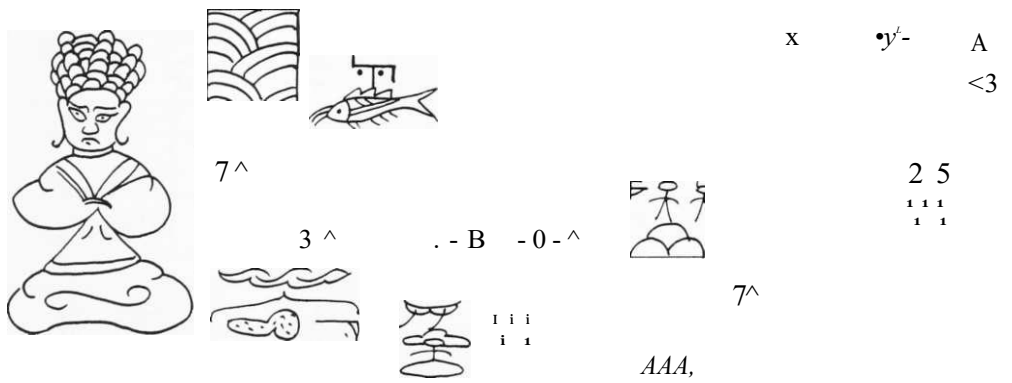
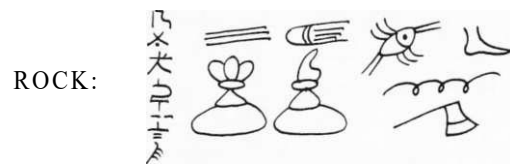

HS. Or, 548/ K. £250. BLAT 2>

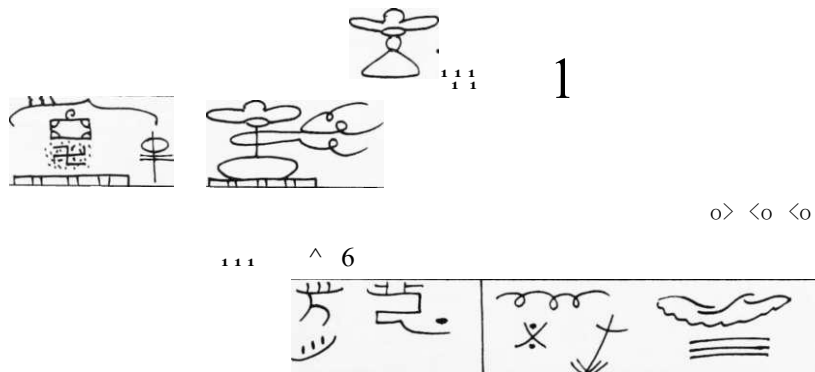

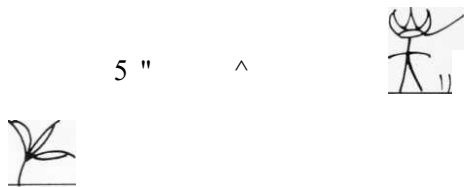

5 " ^

IST

i) in



T to

P



Hs.Or. 54ff/B. £2,50. BLATT 3^

K L

3>

C=3 7

5?

LH

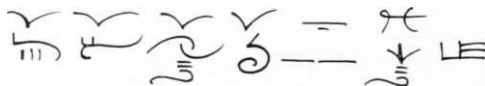

X

CD r ^ ^ t

HS. Or. 52,50. BLATT

f * g F

— =f=

AAS



^ - ^ ^ ^



<0

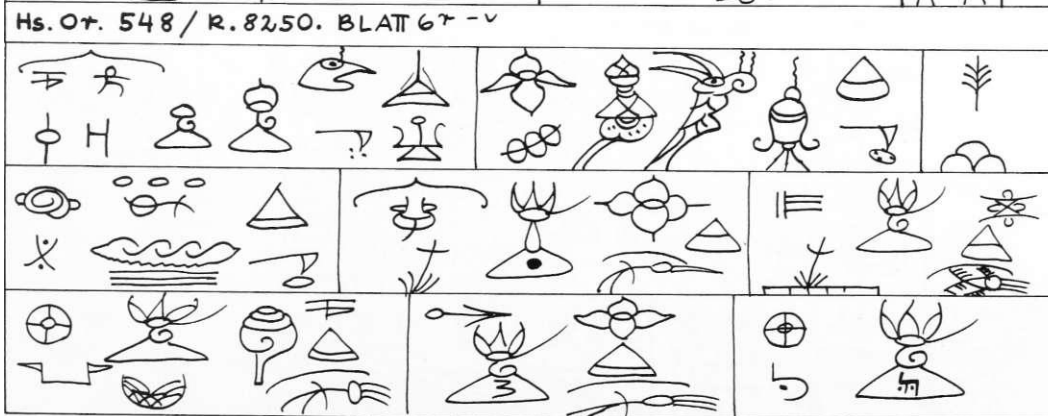
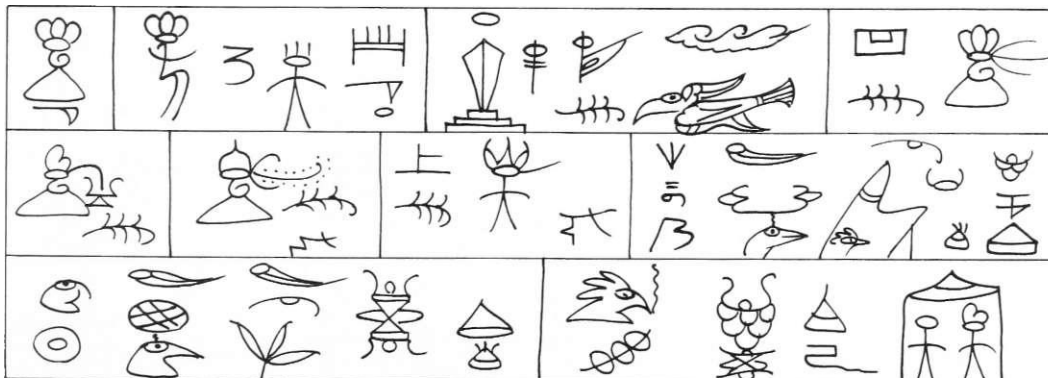
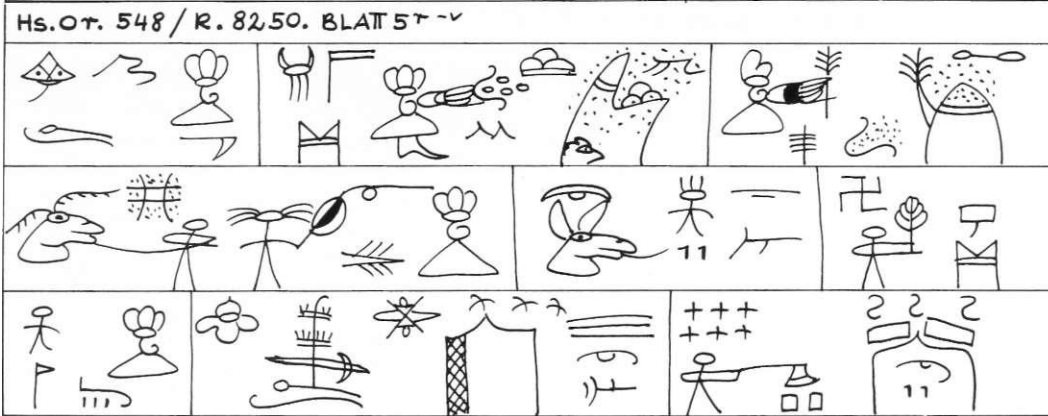

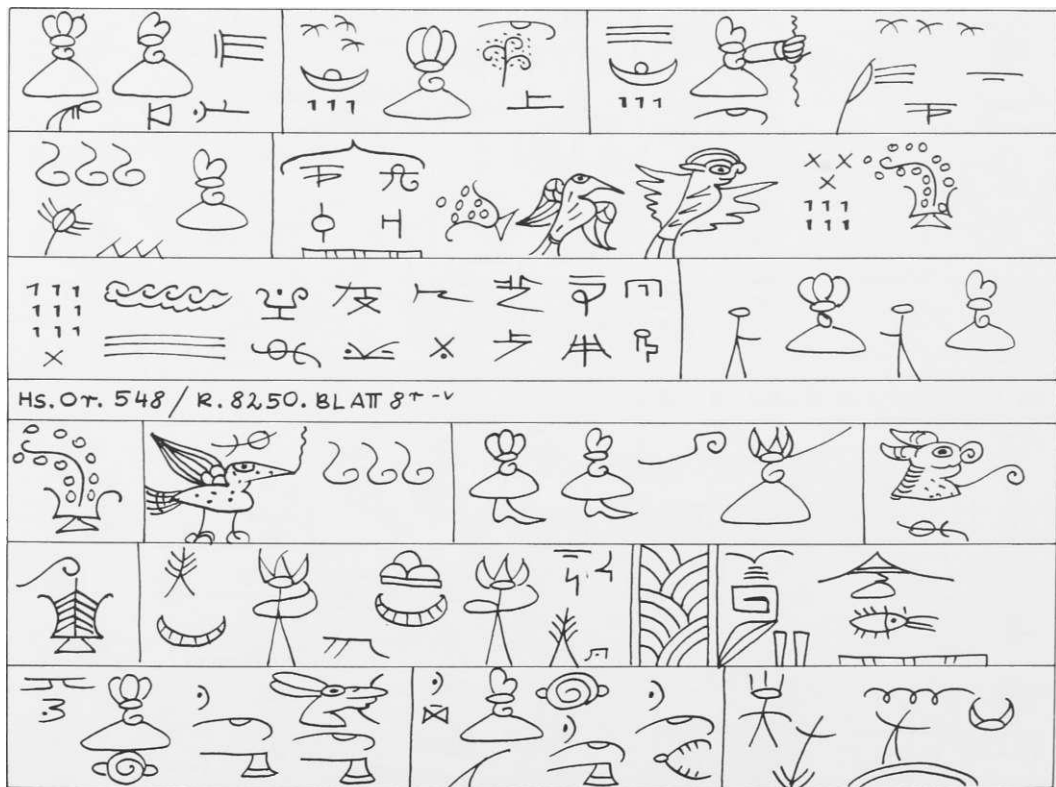
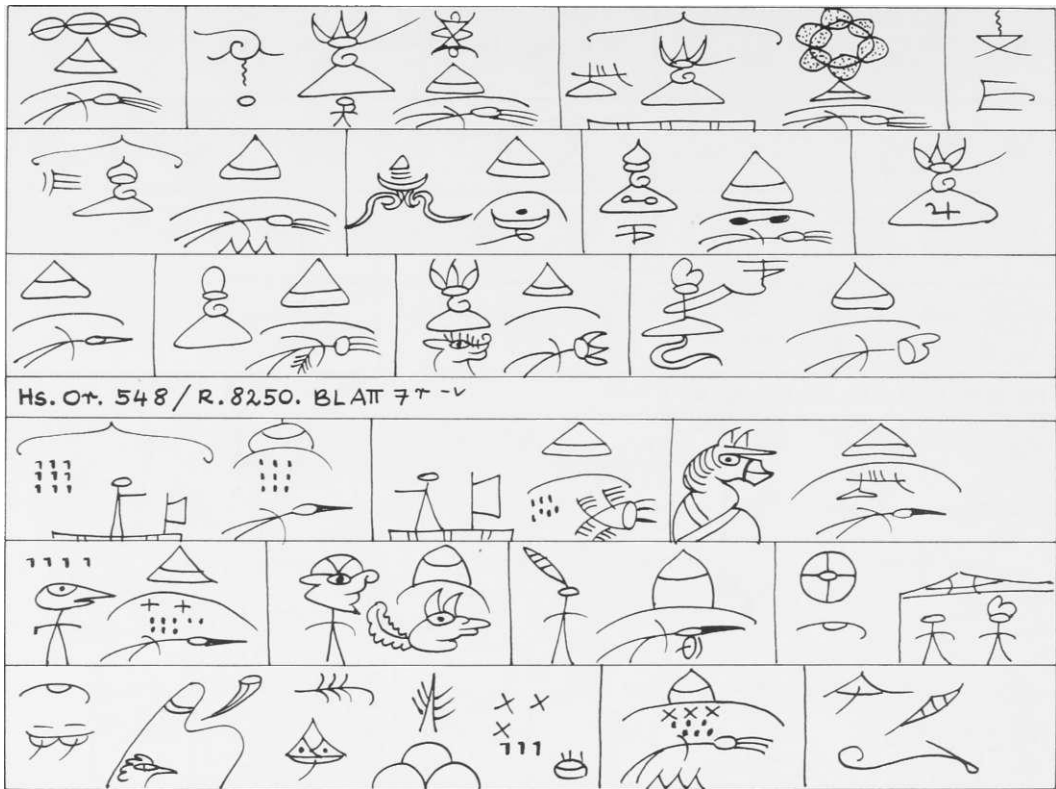

	^ f - * = • ^ H ^
	Y
<i>fr</i> x x	

Hs. Or. 54ff/ie. 8150. BLATT 9^"

2=r...		III CT^O> 111 C^N 111 J

	x	
< > x - > \$		
	Iii x j f f r	
Hs. Or. 54ff/K.8%50. BLATT 10 > ~"		
	@ p / x ' S _	-?r
^ 6 ^ ~ 1 ^	^ Y ^	

*fr**
1 1

	< ^
--	-----

< f > h >

•4r.

CD

0



< 3 >



HS. Ot. 548 / R. 8250. BLATT II**

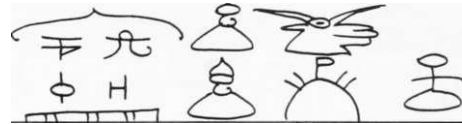

		J i i . x
. 1 — 1 1		

HS. O-h. /K. 8250. BLATT A%-



	^ I
HS. Or. 548/B. £50. BLATT 13^ "	
	FF 4 > ^ _ « -
1 1	177 ^

HS. OT-. 548/e.ff^SO. BLATT1V- -^	

^ L > h) Li ^ "H .) H			
HS. OT. / B. 5X50. BLAT -IS" -Y			
4=7- Lfe i = l			
A •) u	< _ ^ - T 5		1
? ^ % 7 r'	t	» ^o ^ ^ * y -EL "7) u

	n l in X		J F T	~ F "TV
A J . H £			^ F ^	11" TT

HS. Or. 5^8/HZ. 8250. BLATT ""

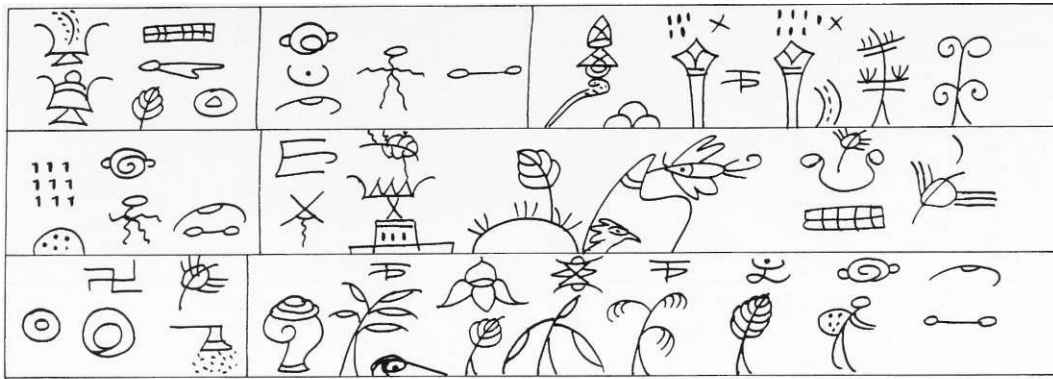

Hs.Or. 548/R. 8250. BLATT 17T-V

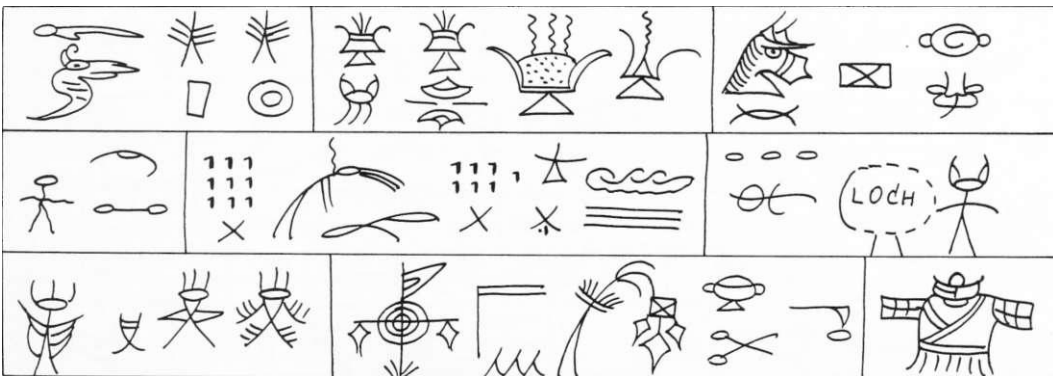
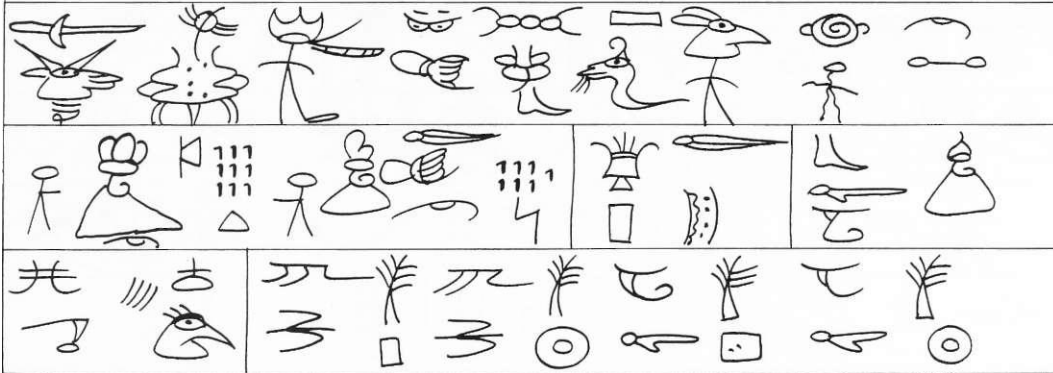

Hs.Or. 5^S/fc. 8250. &LÄTT1\$T-

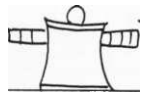

X

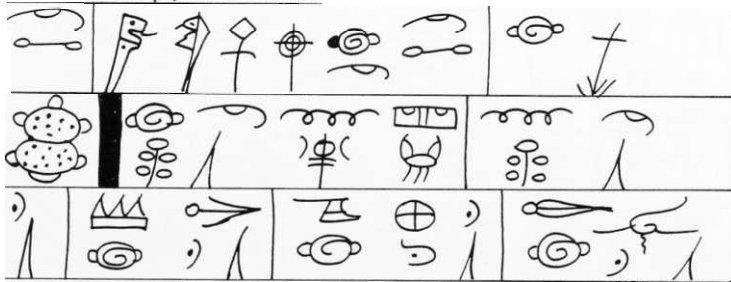

-r y-

AAA		
41? * * m &		
HS.Or. 548/B. 8&50. BLATT 19*r		
		© H
> L0d»A		

		AH
= X	E B B ©	© ~a
tg)	^ m	= 3 5 = Q3? ^)<<
HS. Of- 548/B. 8250. BLATT %07 -V		
v i	

ORJq INALITet- FERUT

x m ^ b - Hs.oT^sim.550/R. 12-45. [Har]ICL-llüfeo.SsüQ-ddo Häshu. BLATT 1^

7 F ^ A/t >

A/ICHT
LCS BAR.

• WICHT
SS/4R.

NICHT
LE4#A*



Hs. or. sim. 550/R. 12,45. BLATT 2/**

@ © >\$C

0Ü7 [gl Lei

< 5

TA

HS. or. sim. 550/B.12,45. BLAT 5

< 5

^ ^ ^ ^ ^ ^ (J ^ ^ ^ ^ / ^ r ^ c ^ r —



X^{s 7} O

HS. or. Sim. 550/R.12^5. 6LATT fe"- v		
		^ 1

l ^ c m ^ ~ ^ ~ < _ J P ^ ! ^ .			
	li Qu X~y		
HS.OT-. Sim. 550/R. 11*45. 6LATT ^T--v			
			** *

	E 3	o ^ ' i "	
Hs. or.sim. S 50/β.		BLATT 5 ^ ^ ^	
ODD	^ -		

		E i " ! ' (3 * ® > \ ^	
R		* ^ I	
		^!///iiii	
Hs. or. Sim. 550/ß.. 12,4 5. BLATT 9 ^ -v			
		DZZO	
	cm ^ -] . :	77 v R ^ « ^ < z ^ R ^ \$ < ® ^	
IS/		⇒ X ^{s 1}	

		D ^ ^ l , * » "XT Ä ^	
Hs.or.sim. 550/R.1ZH5. BLATT 10 >-			
		pT ^ cm Ä •MI IM	

		4 -
ff» W f!i * f		
Hs.or. Sim. 550/B. 12,45. BLATT 13^~v		
	MM MI	
		Mr, Ay
^// IS?		

	*fc — < I A I	MZJH
Hs. or. sim. 550/B. 12,45. BLATT		
FF 0& ^ N ' - s Z = ^		

H T M ^ = _ J h		
Hs. or. sim. 550/R. -12,45". BLATT 15 ^ - *		

7 §3 ^ * BEI		
Hs. or. sim. 550/R. -12/46. BLATT -lfor-v		
	f = - M - ^ E l ^ ~ 3 T ^ %	
4		

		44 ^q ^=' "C's	
Ts---			
ca i t ^		' I S ^ ^ » ^ - S ^ 4+ y	
HS. Or. Sim. 550/R-12.45. BLATT 1^.*.-V			
		CTT~l rrrn j	
		^j ^ [^] Hr- ^ ~ < s - y ? <u>an.fi</u> isa ^	
^ ^ ^ ^		✠ - L F - ^ x h < B - = f	
		= ^ 4 = ^ ^ 4 H " ^ ^ ^ ^ ^ ^	

		\$ X = e i FF	
		jf n v.* ^ ^ - K l 5 ^ 4 - ^ ®	
HSOT- sim. 550/B.-1^45. BLATT IJi'-v			
M			

^ iff M ^			
HS. Or. sim. 550/B. 12,45- BLATT ""			
			2 ^

-# © 'S	7A	OJ 7A
OH		
HS. Or. sim. 550/R. 12,45- BLATTZO^-^		
	e ^ = . ' ^ ^ Ä f 4 ^ ^ an ^	
O « 2 s .	^ " l D oö	D/ #
	W r # l f r	
/T7\ iH 'V X	1 \$ / 4 - ^ f © " -H"	

• S J ^ f o f ^ ^ K s ^ f a n	
Hs.or. sim. 550/R.. 12,45. BLATT 2/1 ^ -'	

	^ \$ £ ^ CID Ä ^ ^
HS. Or. Sim. 550/B,. 12.45. BLATT 2,2, ^ ""	
M ^	
	# ff? > T ^ = ~ ^ r

da Tür >gr-^—?r—*^		OD	<€_>
	V : Ä ®	<<ff 1	
HS. or. sim. 550/R. 1245<< BLATT 23			

n-f^j- ®>	ii S		
		7 A ©<^7A	
		7A <^ © 77\	
Hs. or., sim. 550/R. 1245. BLATT 2,4 "v			
			R
	c 5 ü - ^ 7 //		

Hs. or. sim. 550 / B. 12.45. BLATT 2, T. 1111			
/v; CHT			
• 7A V \leq ^ \ll gf			
		$\hat{f\&B}$	Dun'
LESBAR			

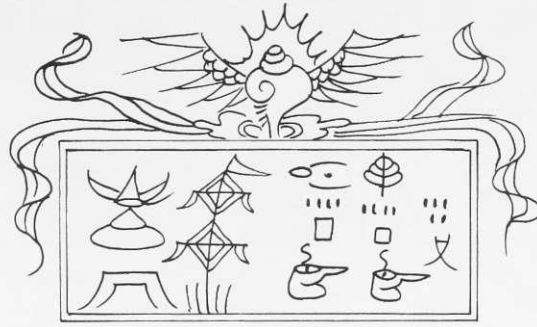

xiii, 97, c - Hs. or. sim. 627/R. 3000. Hä-r la-llü kö, K'aw-zhër dzu. BLATT 1r-v

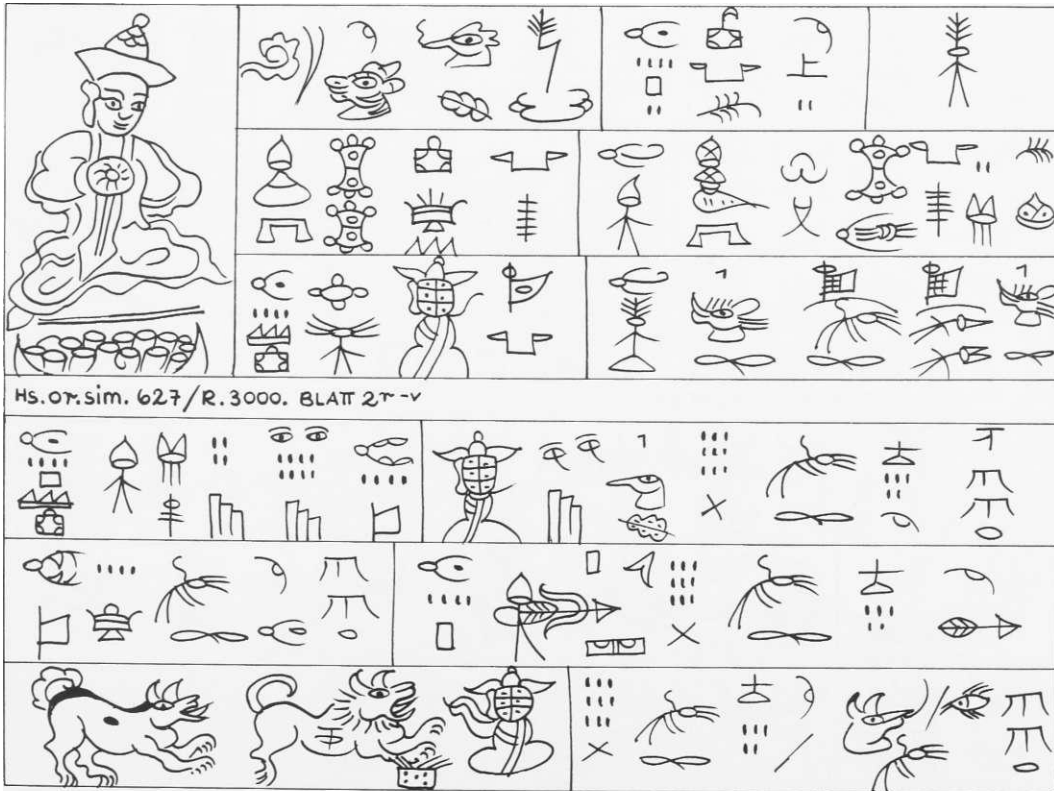
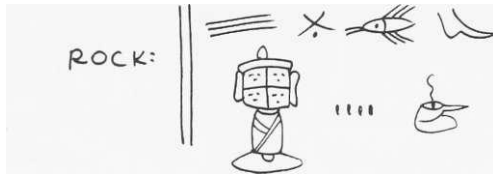

1 - r - fTT) oAo	^ , 3 g ' f (^4 -) - (- ^ 5
^ fei j 7	e s c % ^
HS. or. sim. fc2,7/ie.3ooo. BLATST--*	

"\			
* [®] 1 _{® = CED ~}			
Hs. or. sim. tb2.7-/R. 3ooo. BLATT (b^...)			

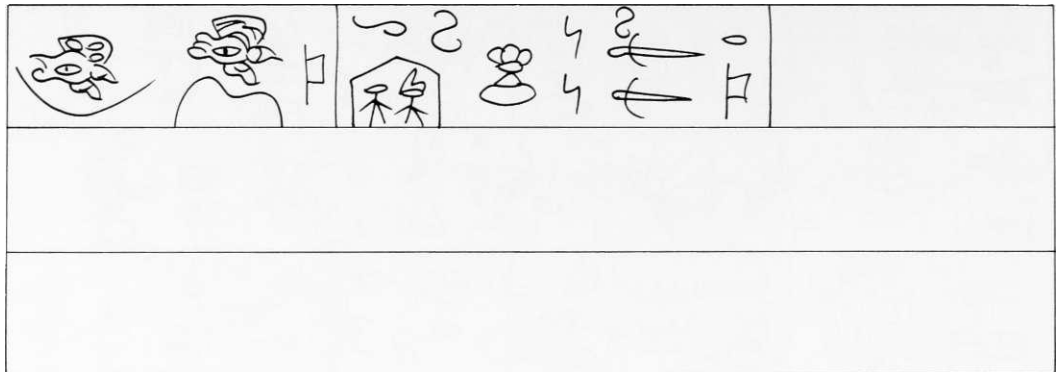

HS. OT.sim. <o2,*/R.. 3000,BLATT -J.T--V

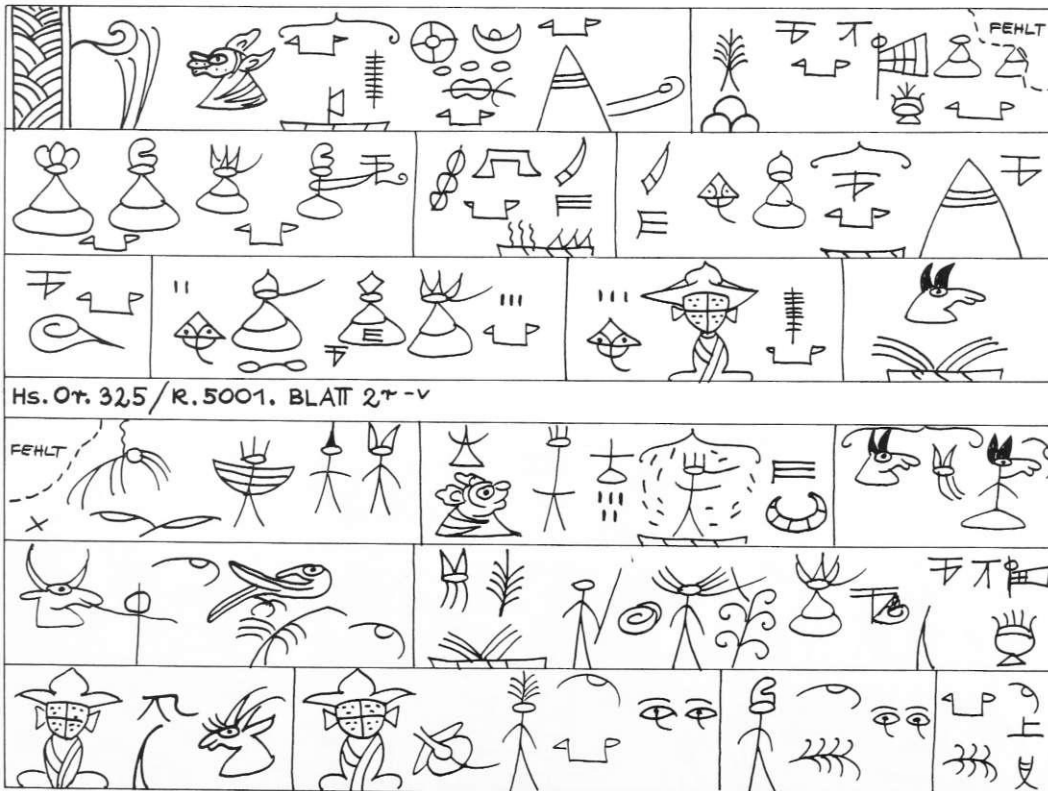
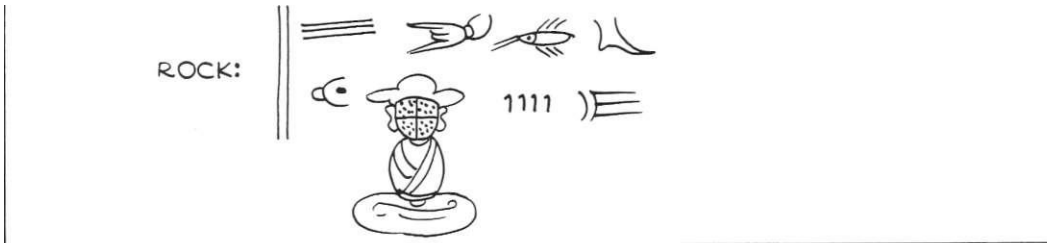
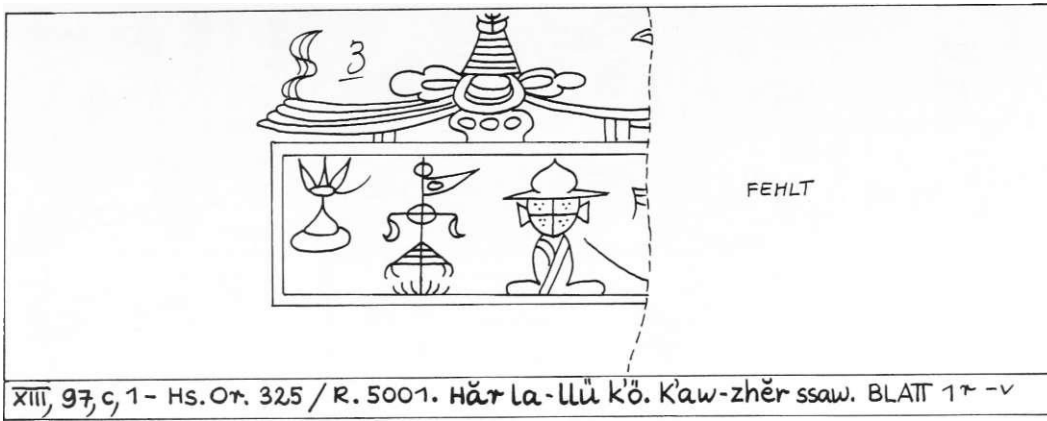

Hs. Or. 325 / R. 5001. BLATT 2r-v

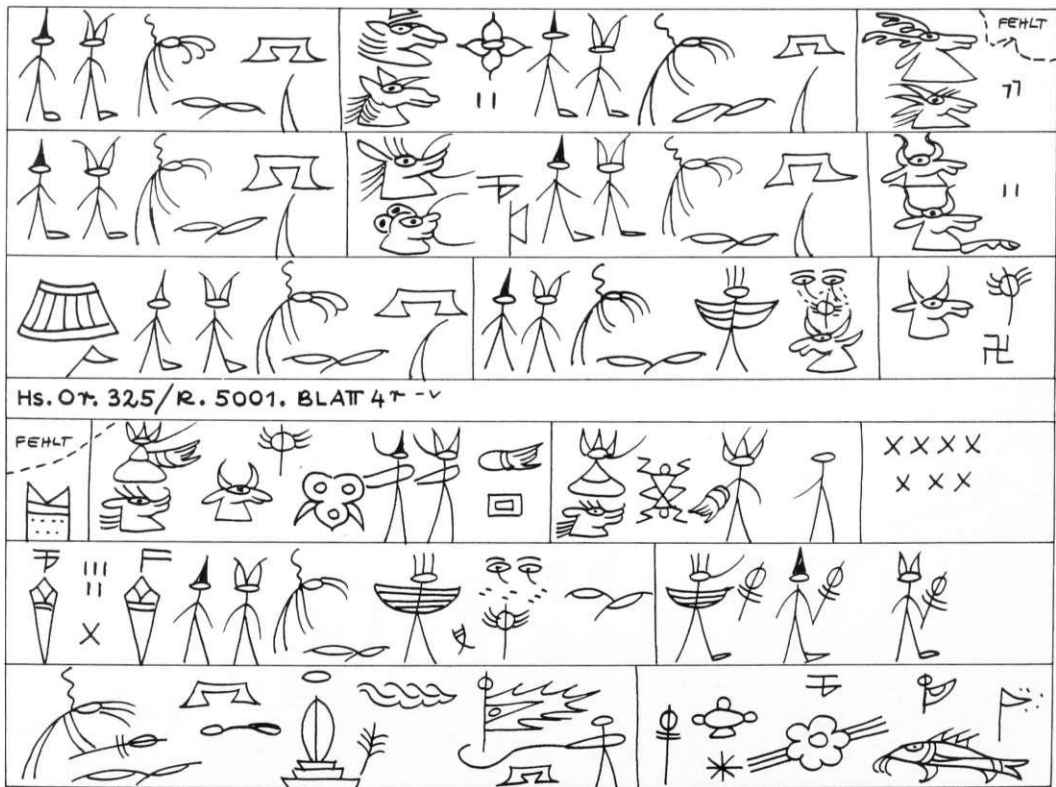
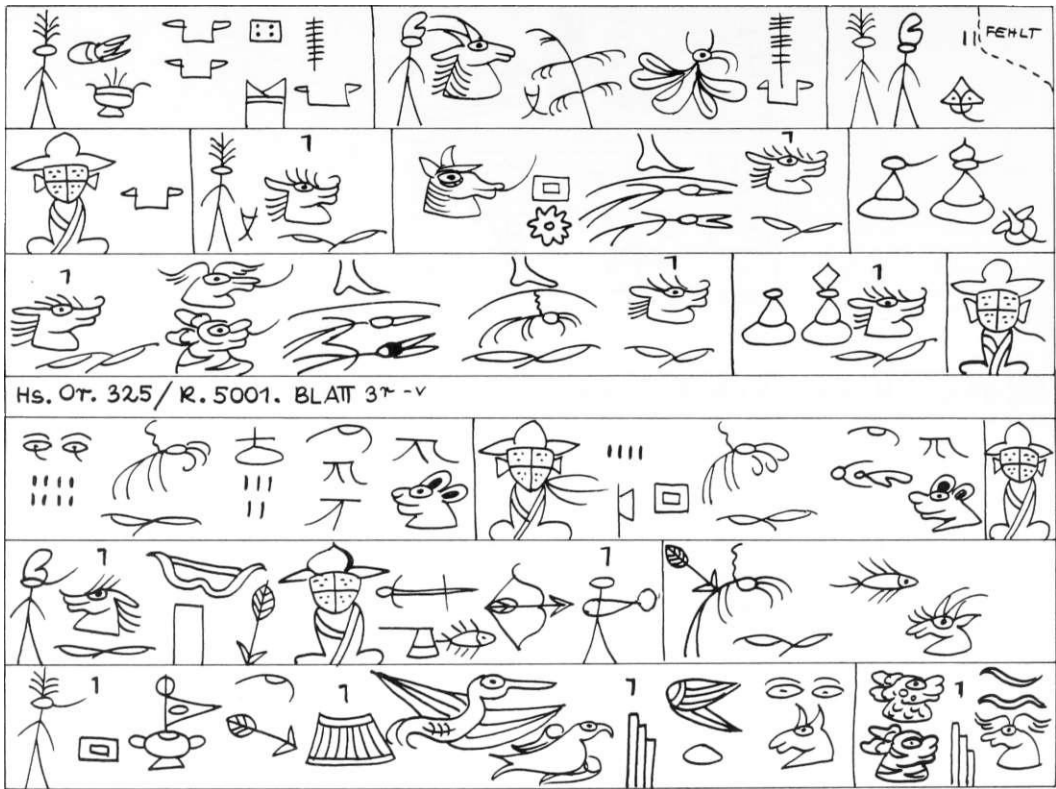

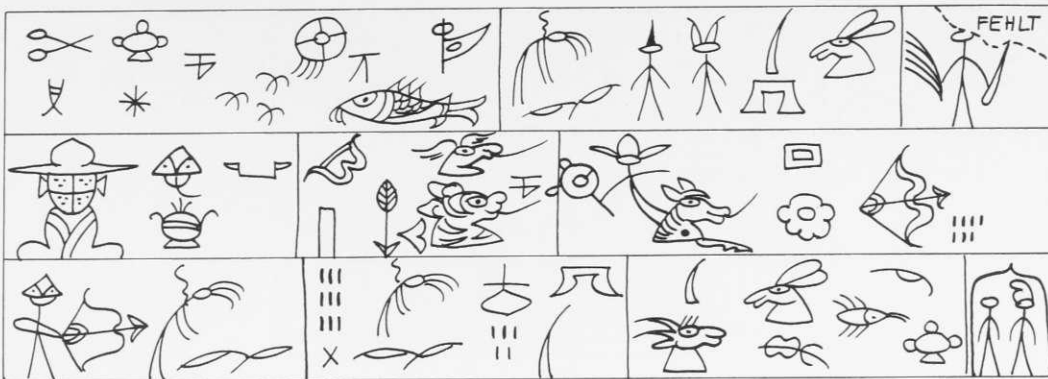

Hs. Or. 325/R. 5001. BLATT 5r-v

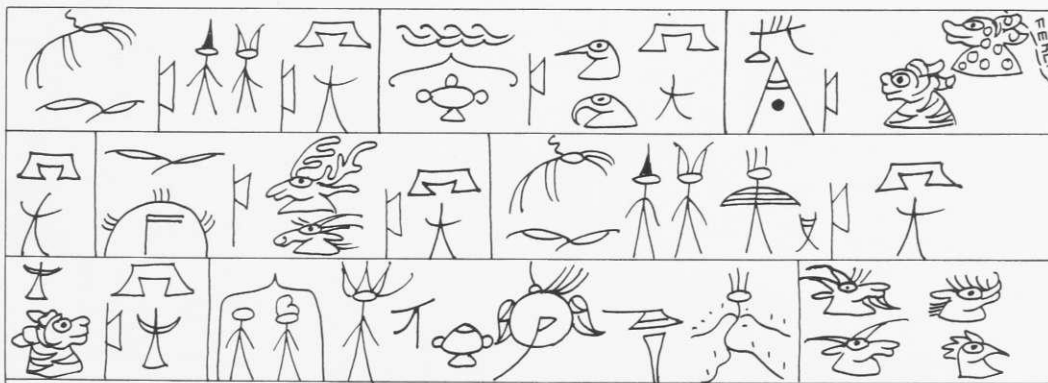
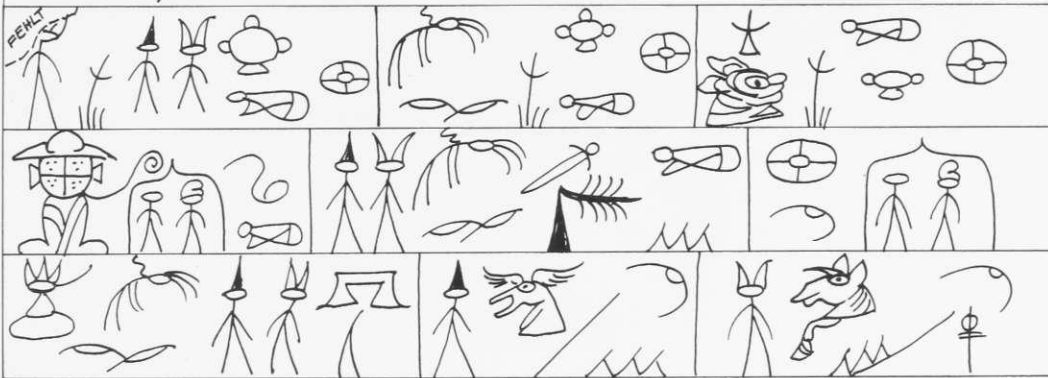

Hs. Or. 325/R. 5001. BLATT 6r-v

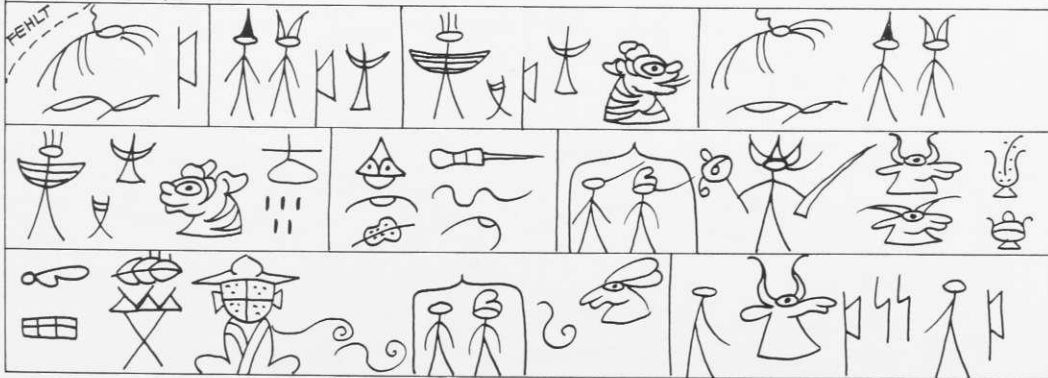

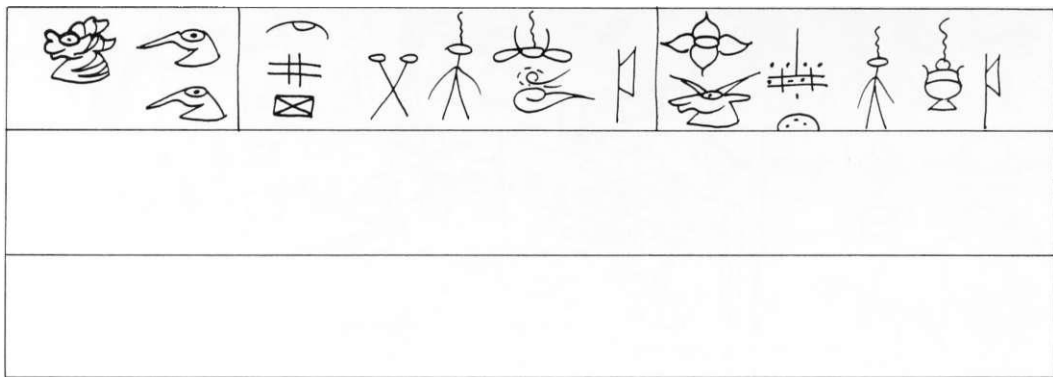

Hs. Or. 325/R. 5001. BLATT 7r -v

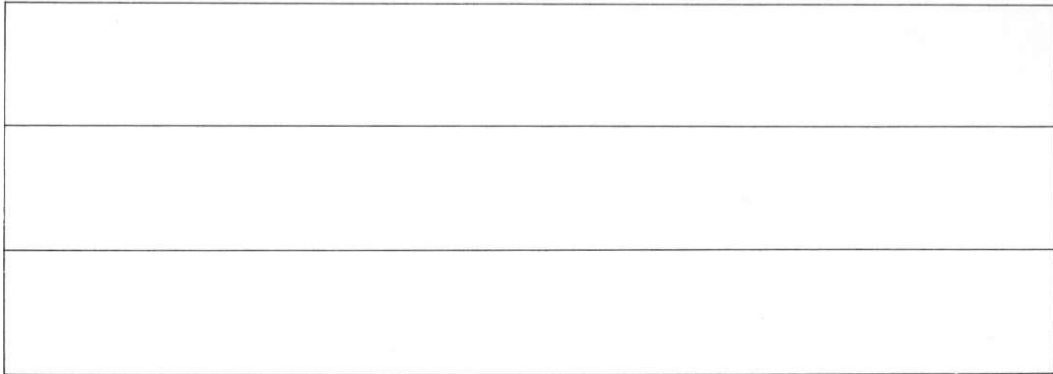

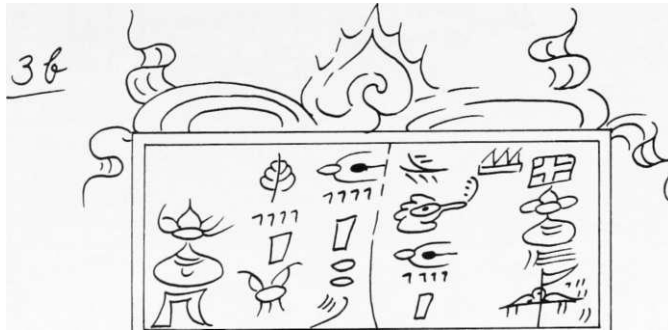

xjj^jfre, Z-Hs.o>. 3U>/R. 500£. HcLr La-lUH ko. KW-Z-her khyu.-z.her* ssa.w.

BLAT 1*--V

ROCK:

£ > i * y ^{2?}

71 < 5 < ^ < j g ^ < t /

HS.OT-, fe. 5002,. ^üAAA BLATT a,"*-"

i l i l flu l ¹¹¹ll

^=0 TP -

"TT : 7 r v

CD

v TT

¹¹¹in x

W.r. £ in B

11

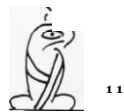

.>i//.. 6 3

	.. w .. a		ft
	- I		
			l i
HS. OT-. 2>Z(o/R.. SOOZ. BLATT 3 ^ - ^			
	- ^ G v - ' ' ' ^ ^ > X , a a		X m i
>iii ^<S.	L X		



Hs.Or. 3Zfc/K. SOOZ. BLAT4 >



1



rrnn

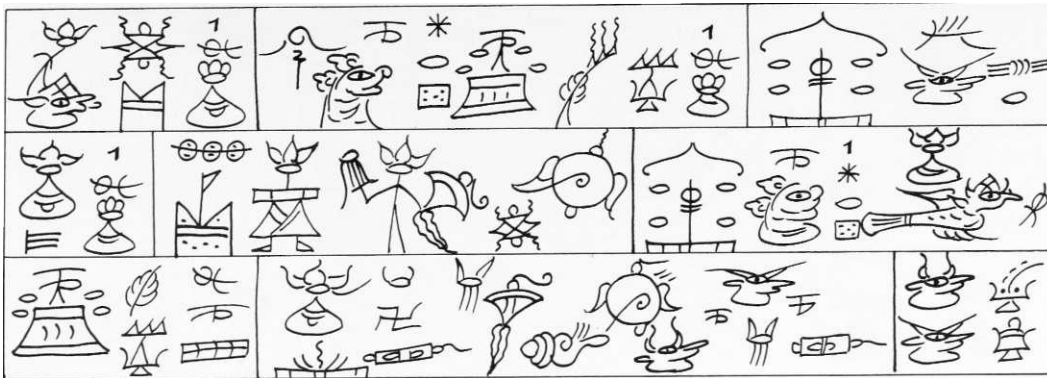

HS. Or. 2>Z<o/B. SOOL. BLATT 5 ~

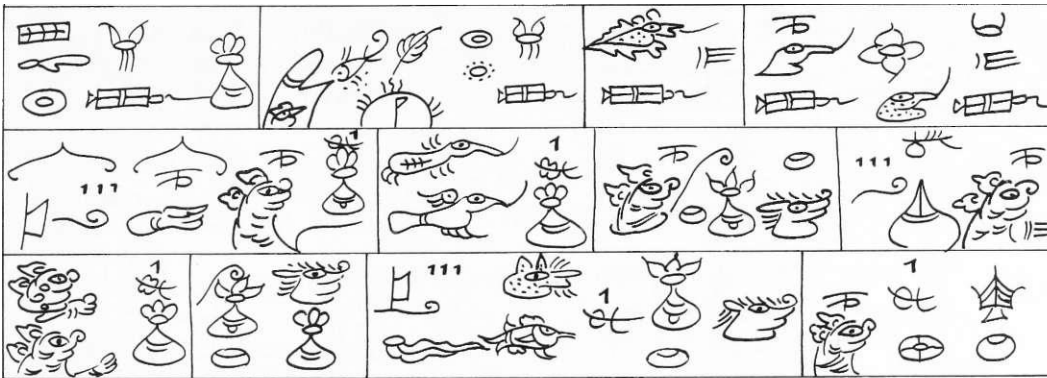

HS.0t. 2>2j<ole. SOOZ. BLATT

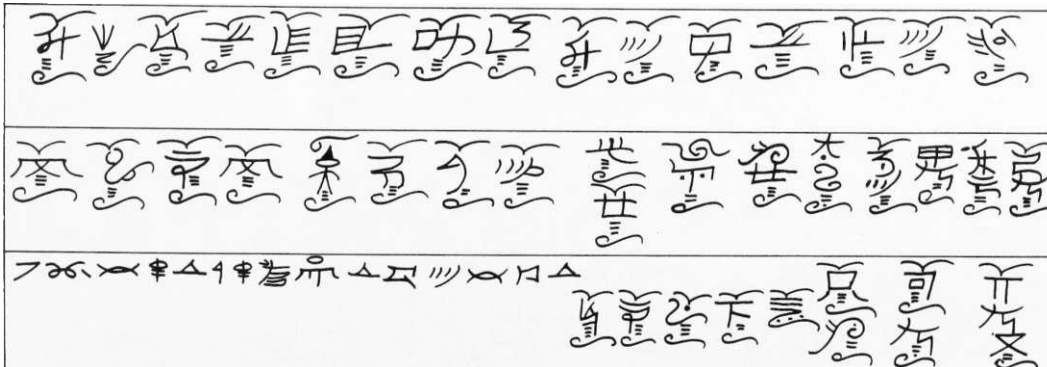

			''''
			17 E 1

Hs.Or; 32,fe/ fc.5002., BLATT [^]-v

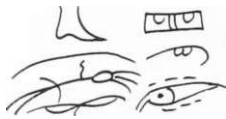

^ - 1

1

''



D dCd ANT



Hs.Or. 326/R. 5002. BLATT 8r - v

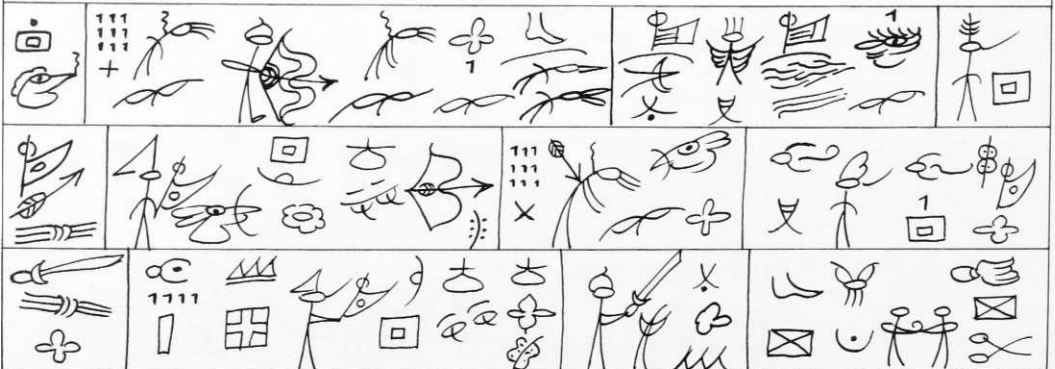

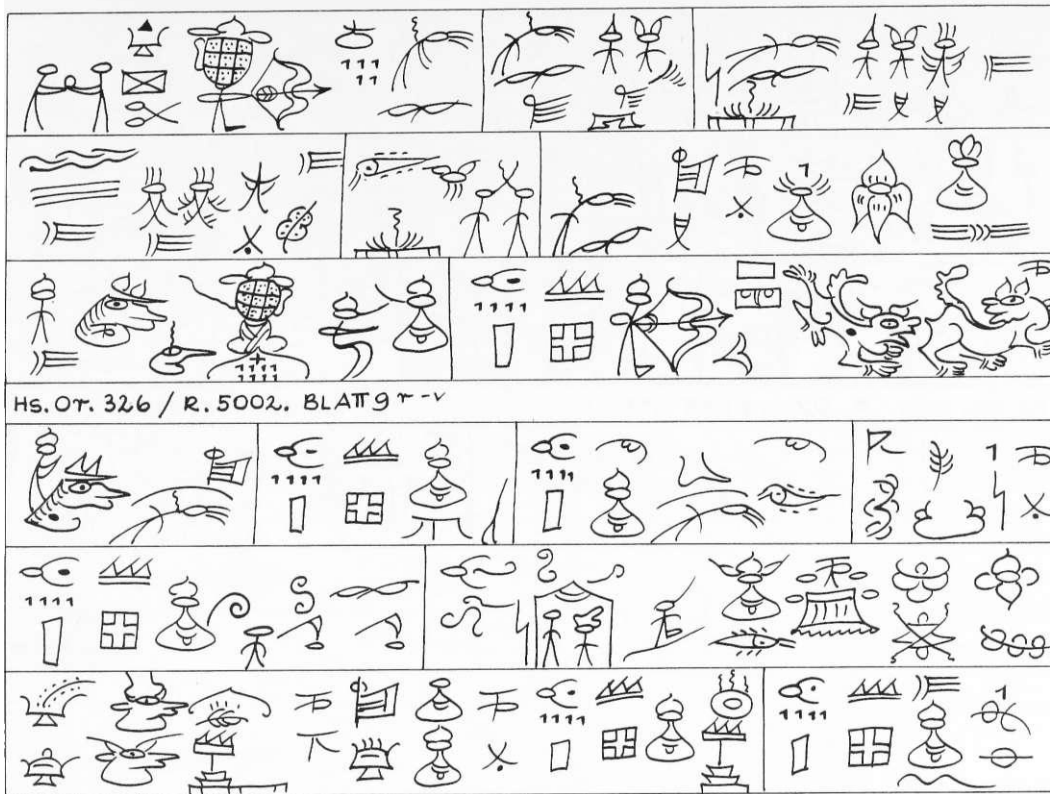

	n 11	-	
		Tin	L L ä " a b -
		... / 111 s + 7	
=C^	6 /	j Ö g ^	
HS. Of. 2>1b/R. 500Z. BLATT 10^" -			
		1111 / Ö S v ^ 1	^
	^	p	

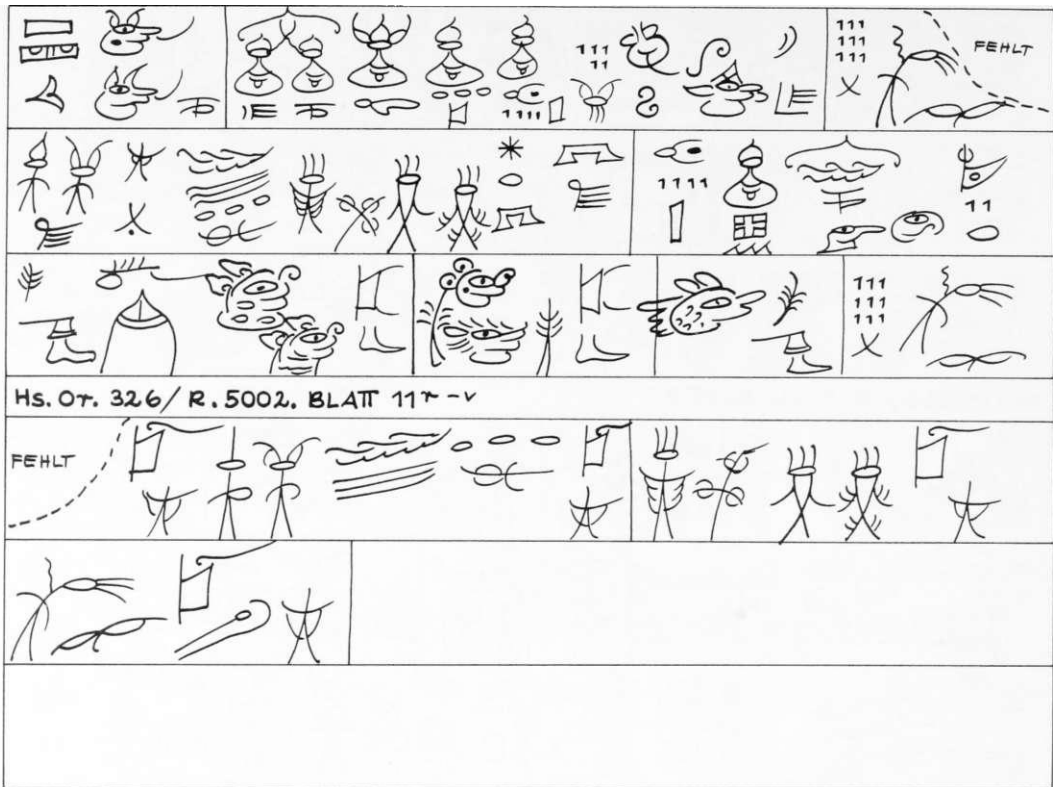

			^	AAA ' tf^
HS. OT. 31fc/B. 500^ . BLATT-1^"*				
Ä \$);)			
111				
h " I i x)3				

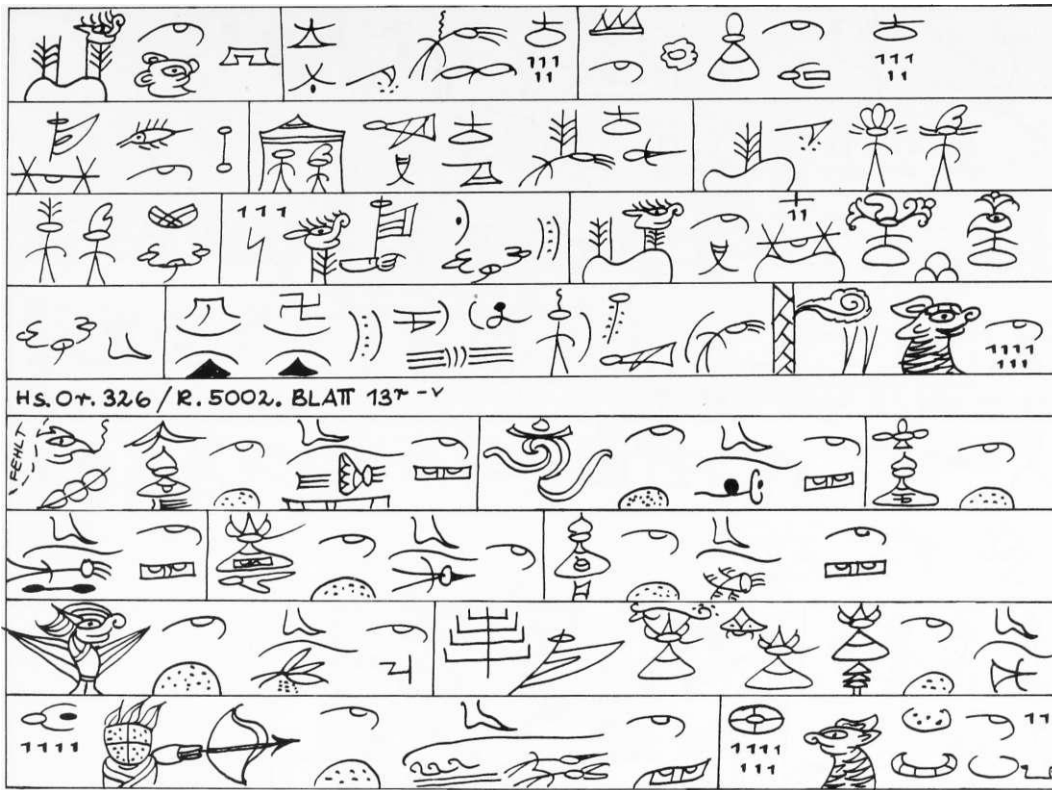

Hs. O+. 326 / R. 5002. BLATT 13^{r-v}

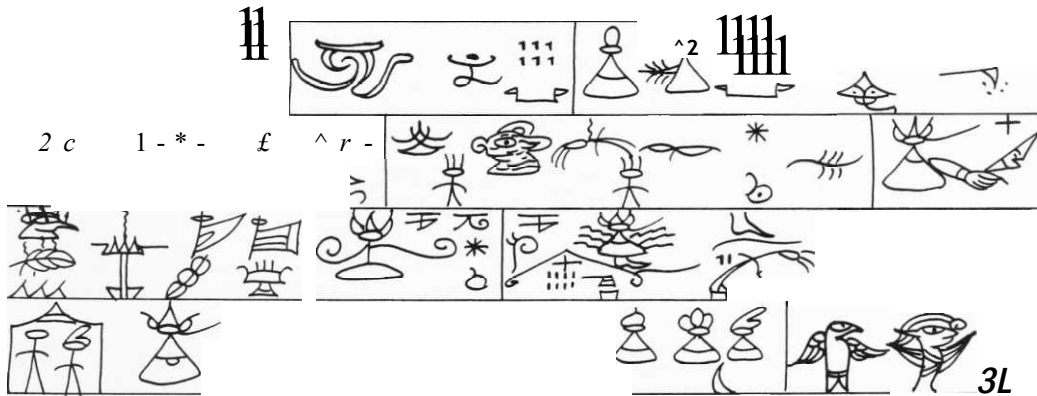

HS. QT-. 32,fc>/ lg. 5QOZ. BLATT 1[^]'''

C 3

* $\alpha C^{\wedge} - III_{dq} im \wedge T^{\wedge} 0$

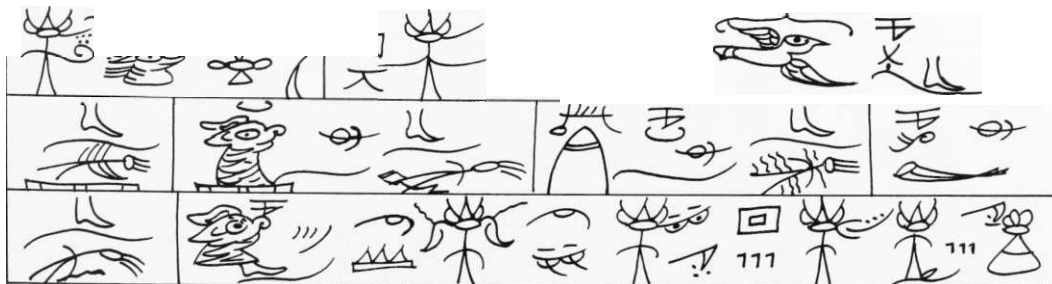

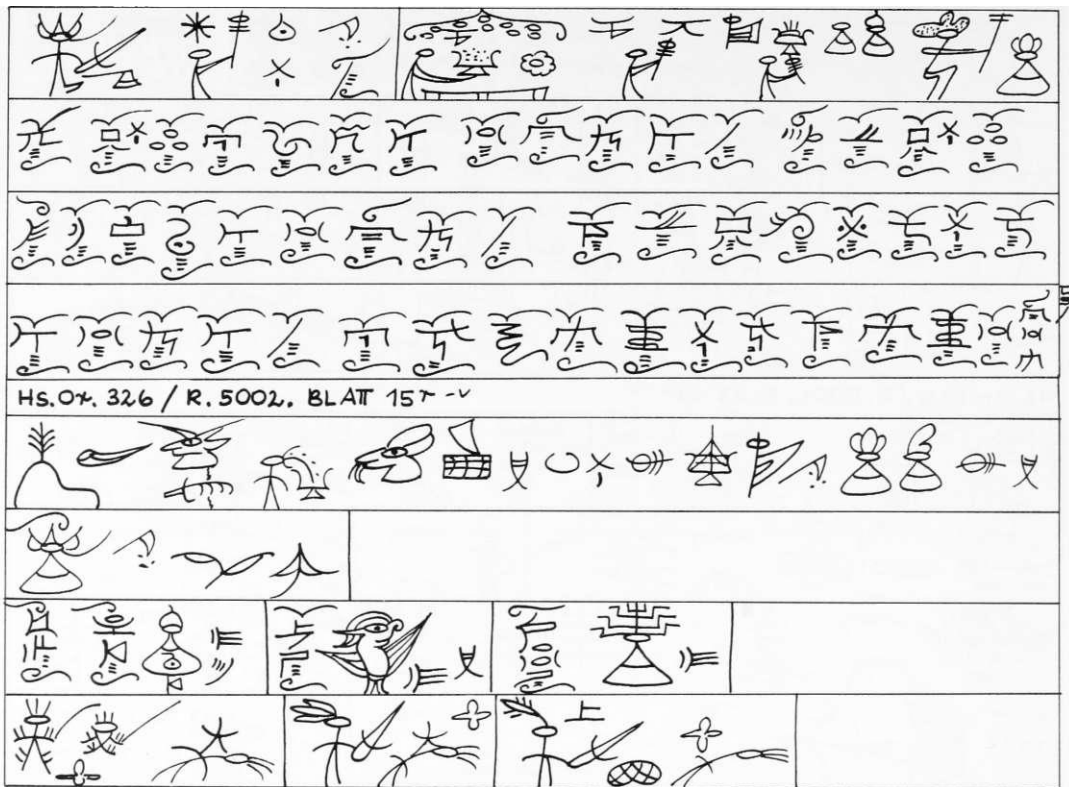

Нѣ. 07. 32,6/К. 5002., BLAT Ab¹⁰ "r



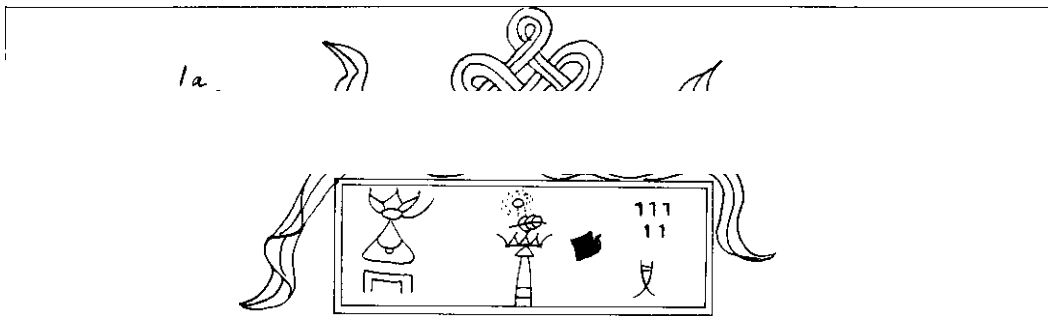

XÜT,9?, d - Hs.Or. 54Aj/ie. 82,39. Hfo-la-UÜ k'Ö.Ch'uncj-bpa n^yi. BLATT IT-

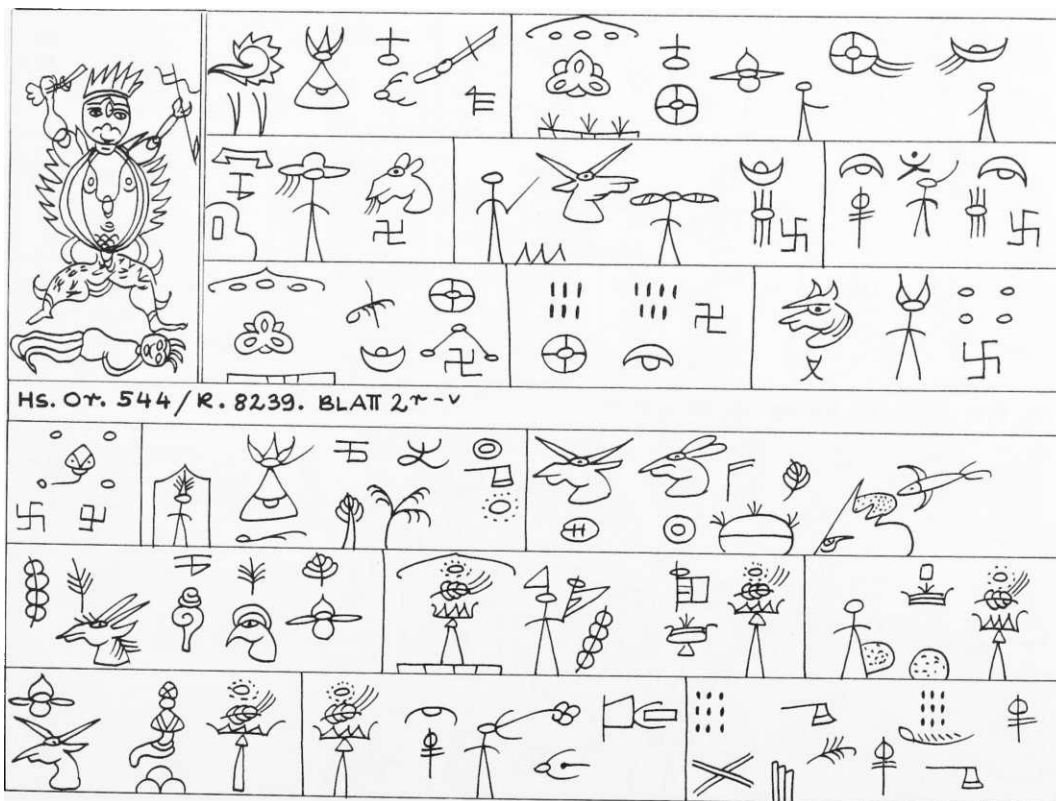

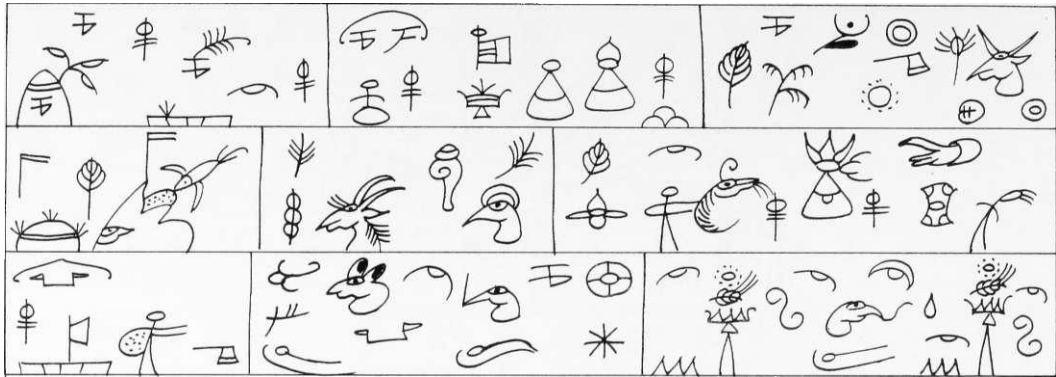

HS. OTT-. 5£f4/ ft. 8%Z9. BLATT -v

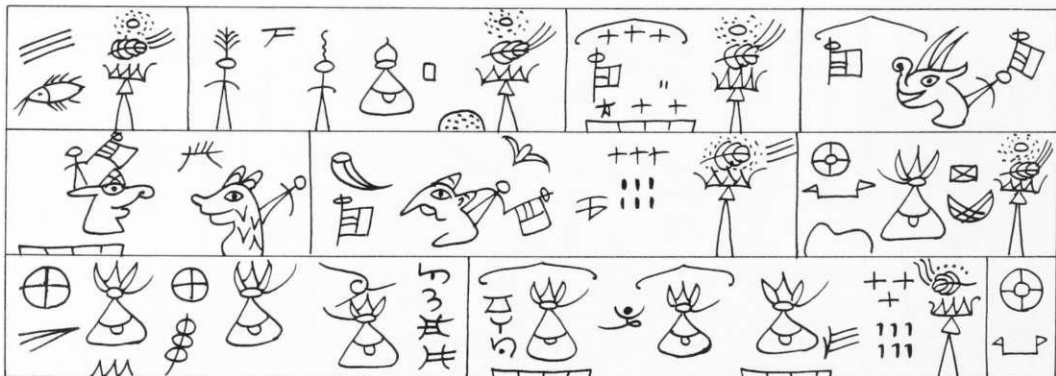
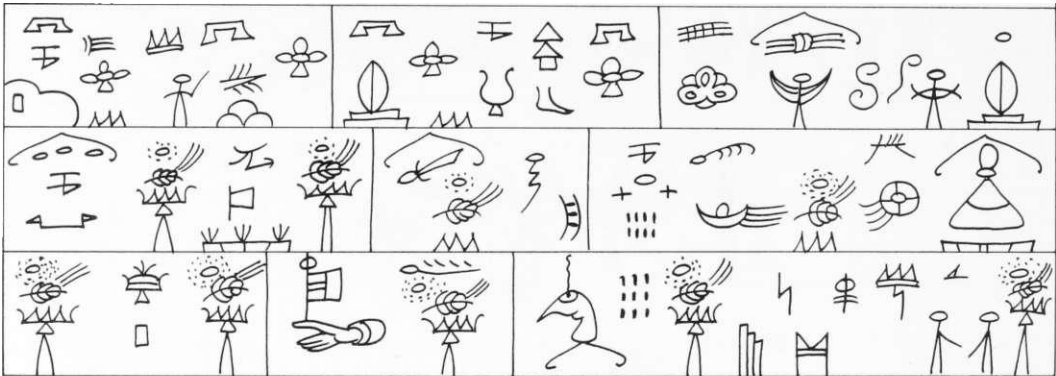

HS. OT-. 54Vie. ^2/39. BLATT 4'''

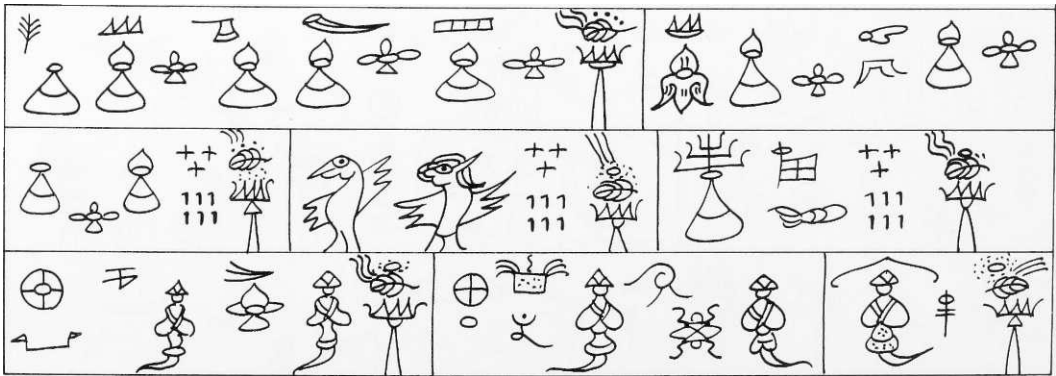

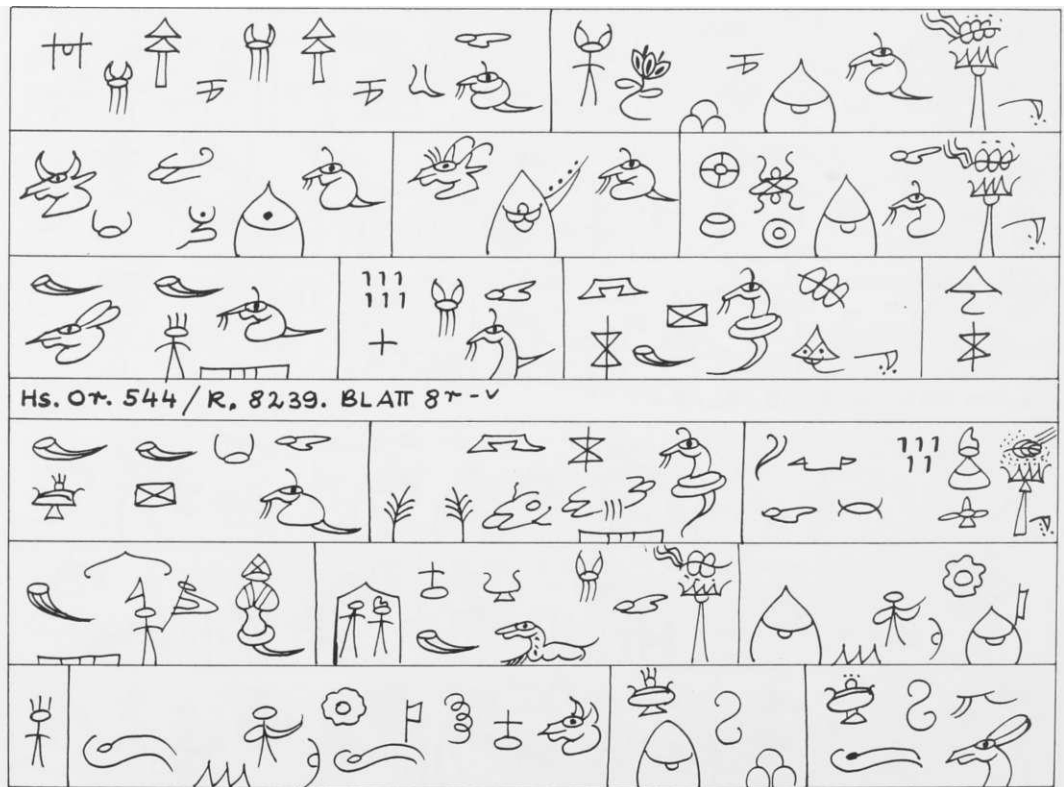
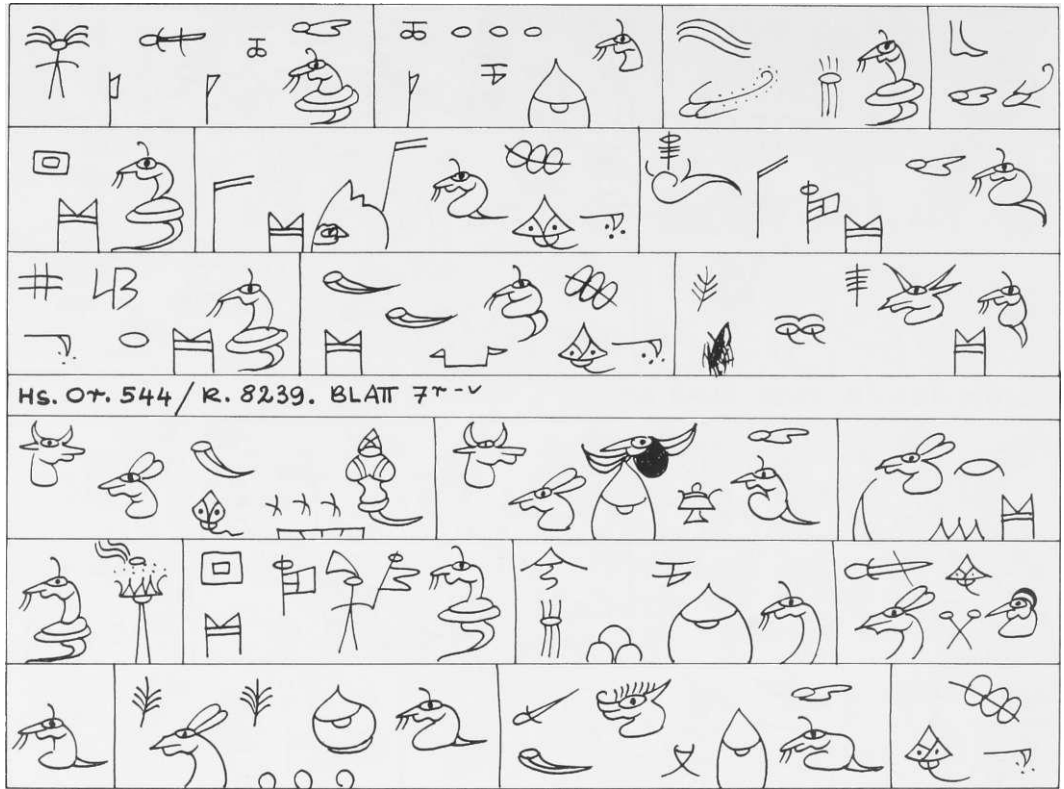

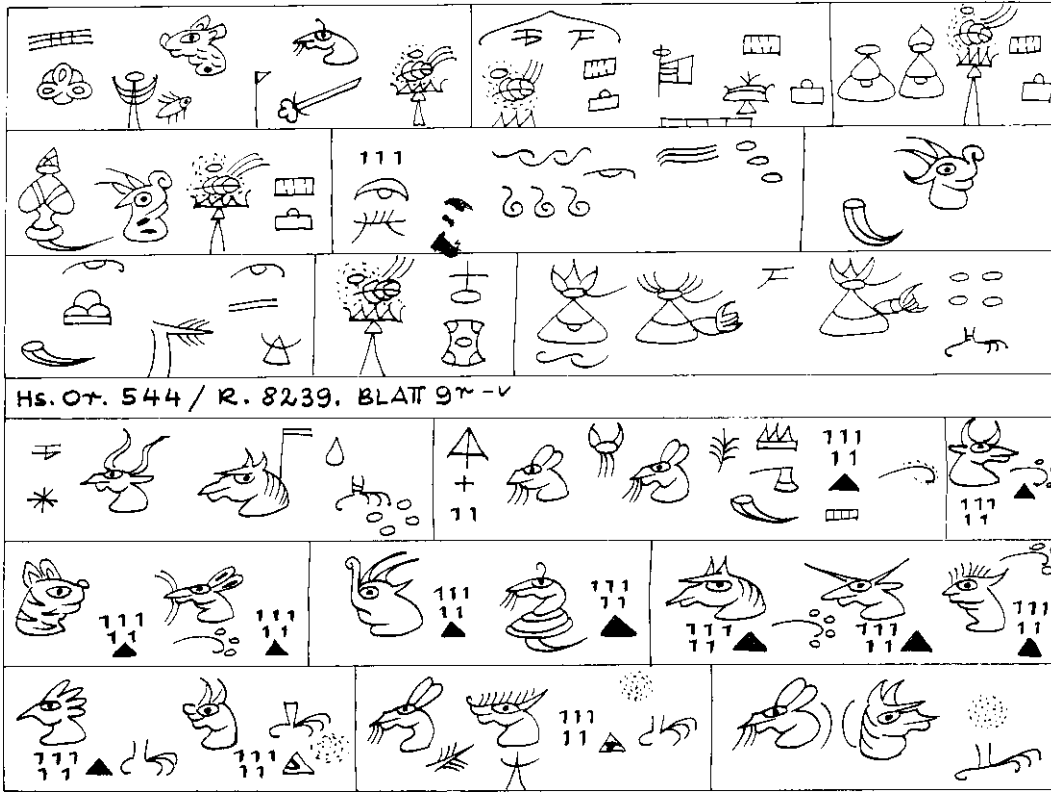

Hs. Or. 544 / R. 8239. BLATT 9^{m-v}

		*4) C ^ ^ P			
				1 1 1 ^T3.L^o ^o	
				^ W A	
HS. onh. 544 / k. s^s9. BLATT 10 ^{m-v}					
i n !	i n 11	i n i n	lit	m i	111 . 664 .
					o o o + + o 1.11
			i g t		l o ^ ^ ^
				f - a . ^	*, ö am
				03=0	ma\ ••

$\text{£ }) \diamond A \triangleleft \text{Ii}^a$		

Hs.Or. S44/fc. £&39. BLATT 13>



	INKS
--	------

SIFT, 9? e - Hs.Or. 49 G / K - S ^ O ^ A . HCLT- IGL-ULL k'o. khyw-zher bpo-mbo ssaio.

BLATT

ROCK:  1 ^ 3 n



77^



7TU

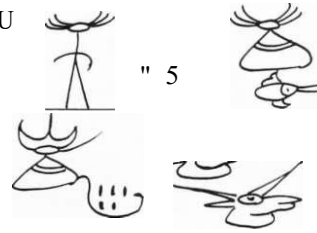

Hs.or. 49fc/ie. ezo/f A. BLAF ^ ^ ^ ^

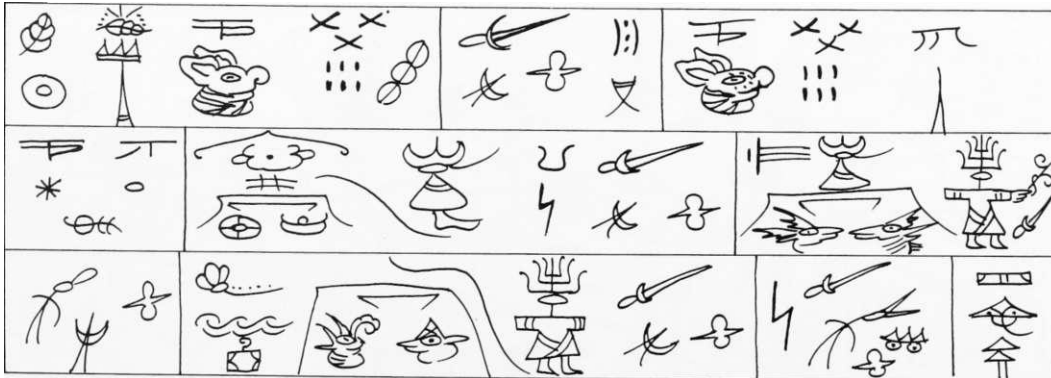

Hs.Or. 49<b/B. 82/04. BLATT 3>-^v		
* o Ä		

		— ©
Hs.Or. 49fc/ft. #2,04 A. BLATT 4[^] "v		

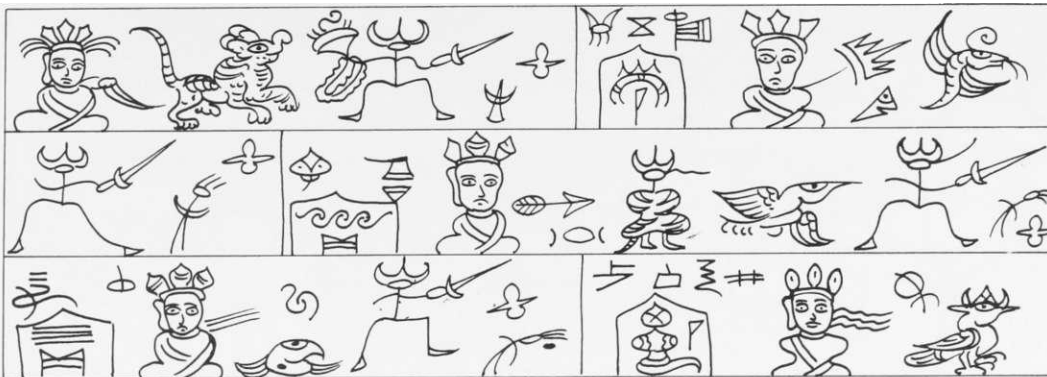

Hs. Or. 496/R. 8204A. BLATT 5r-v

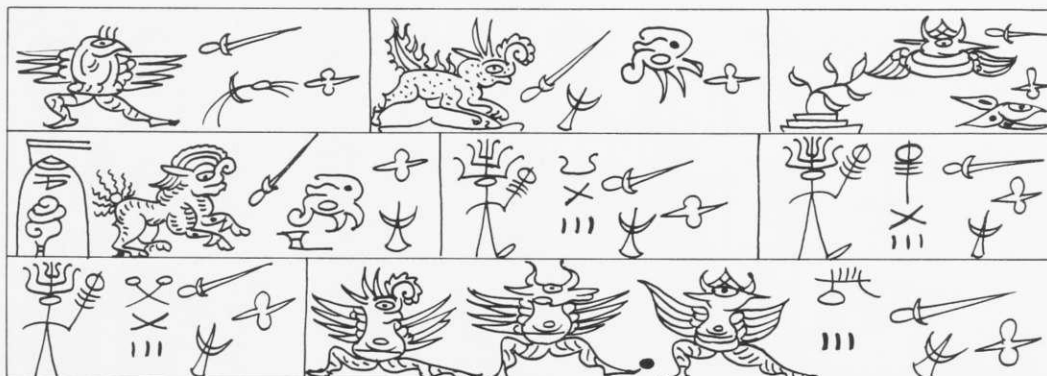
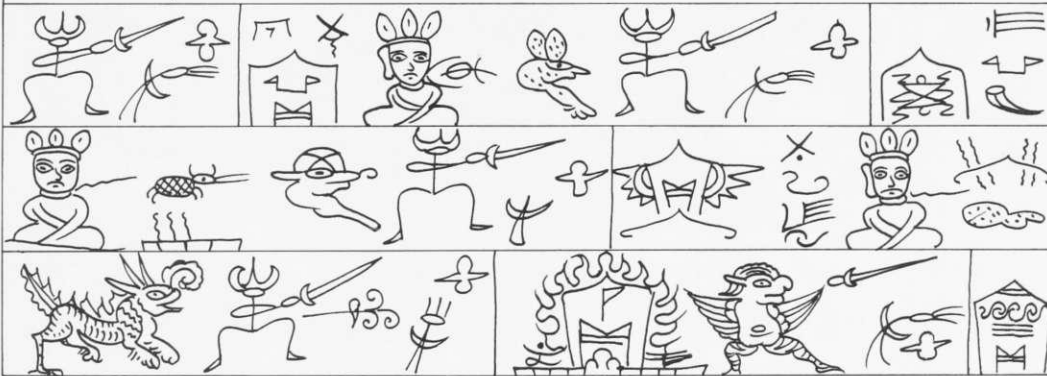

Hs. Or. 496/R. 8204A. BLATT 6r-v

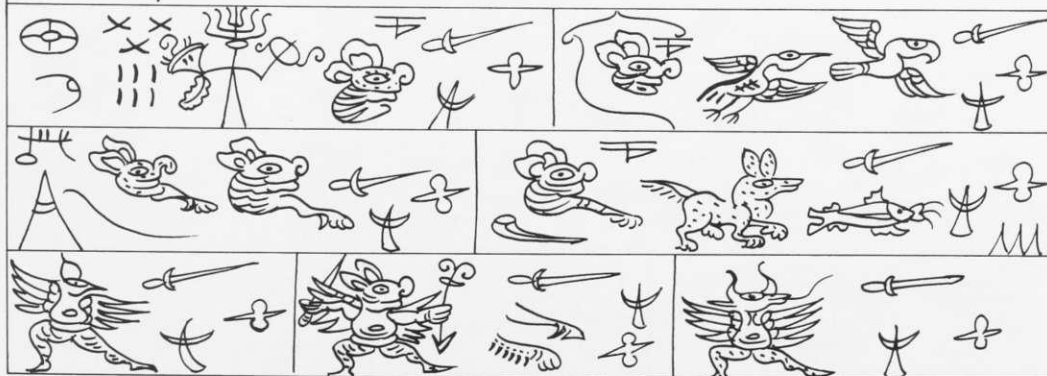

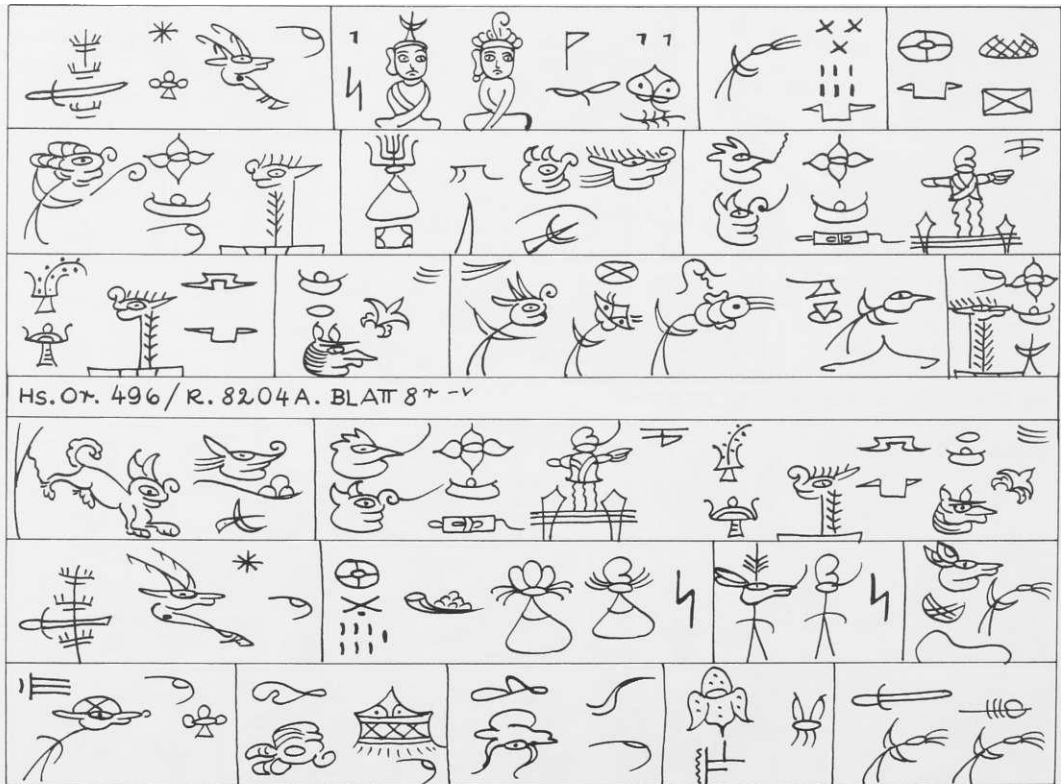
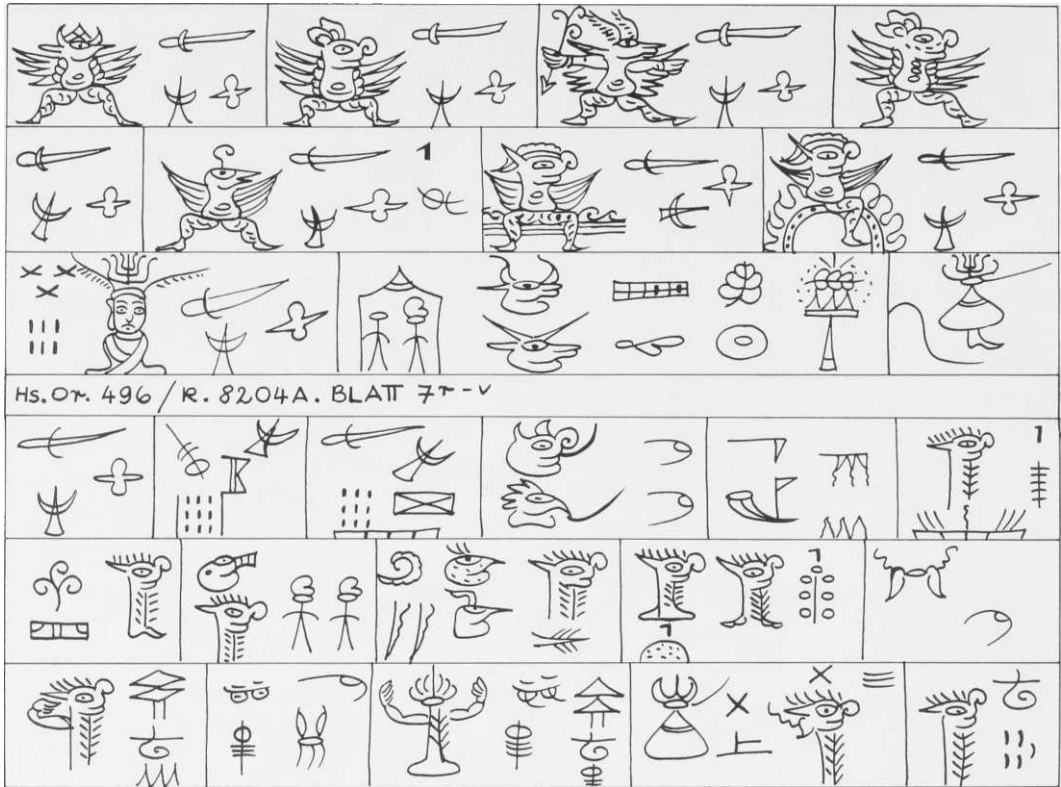

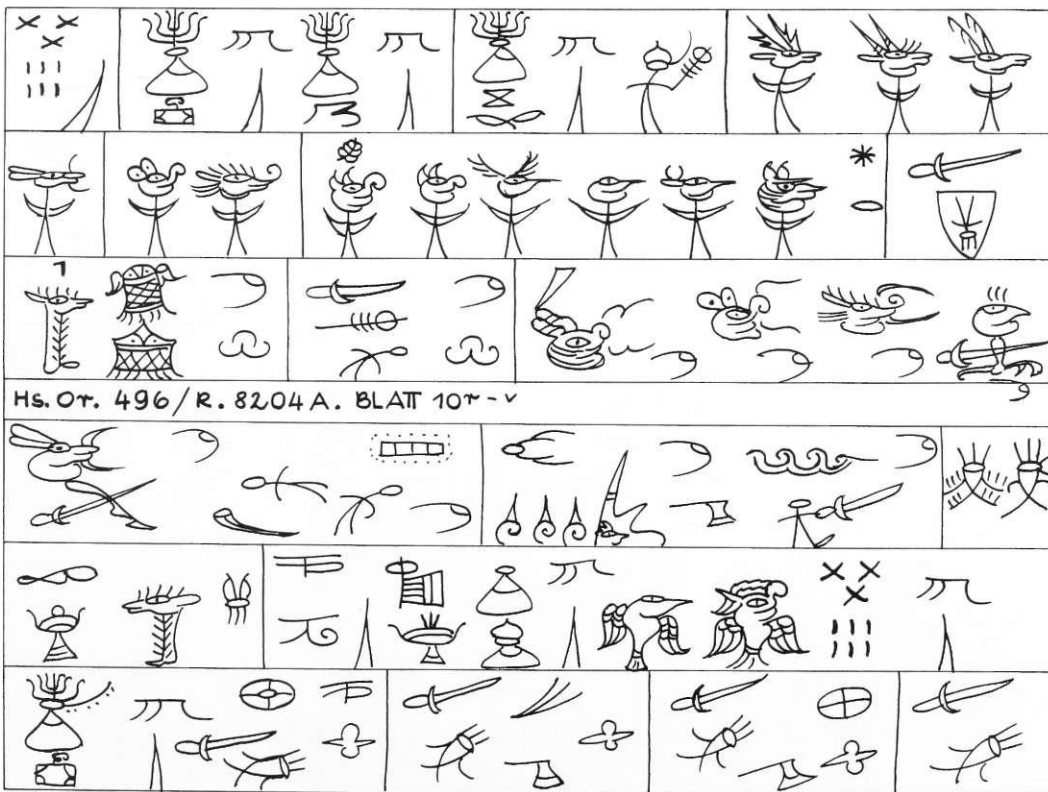
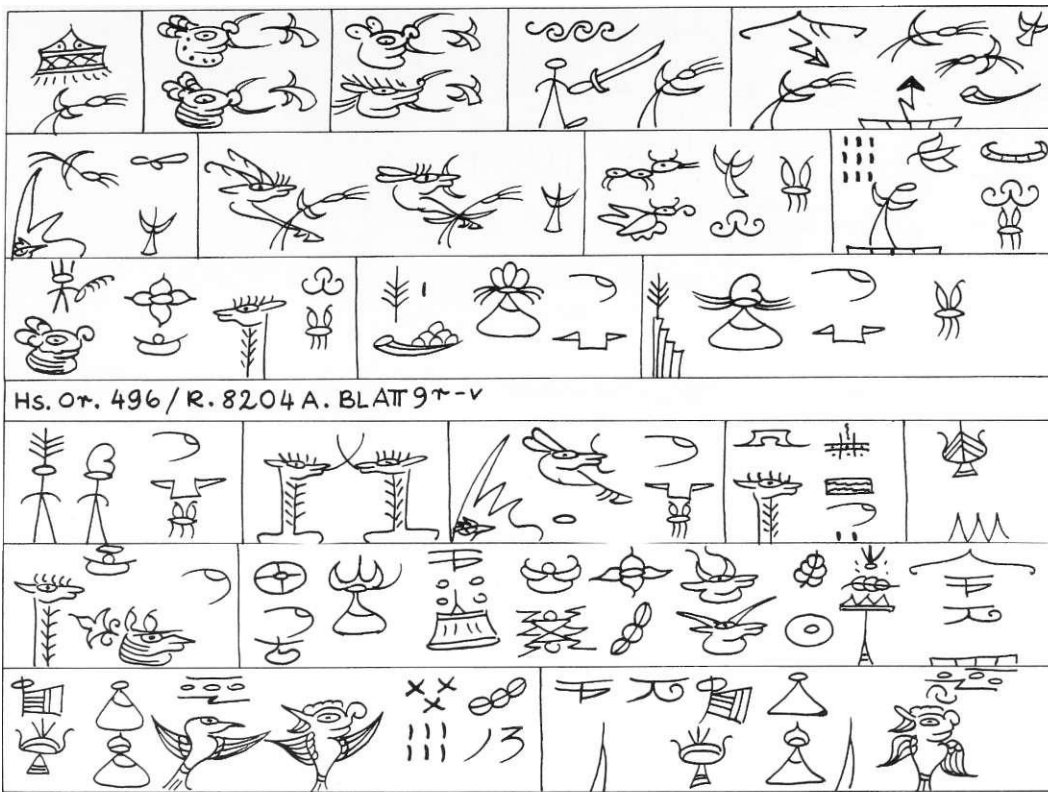

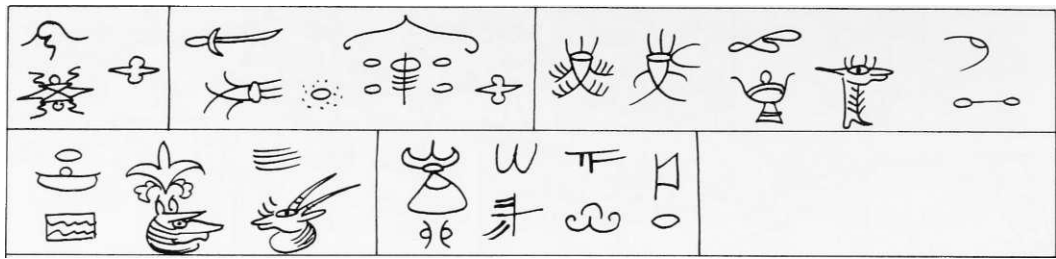

HS. Or. 49fe/B.

A. BLATT

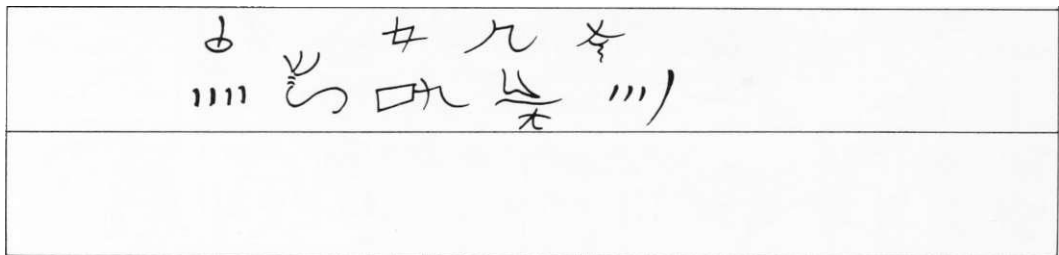

HS. Or. 496/R. 8204A. BLATT 12^{r-v}

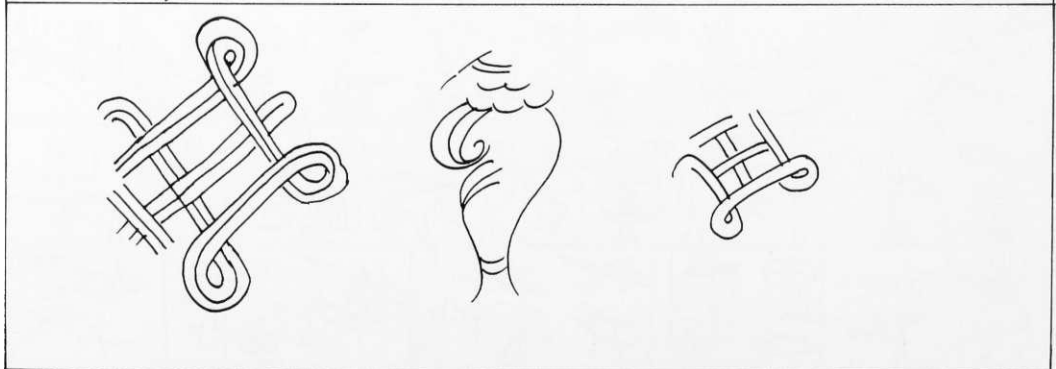

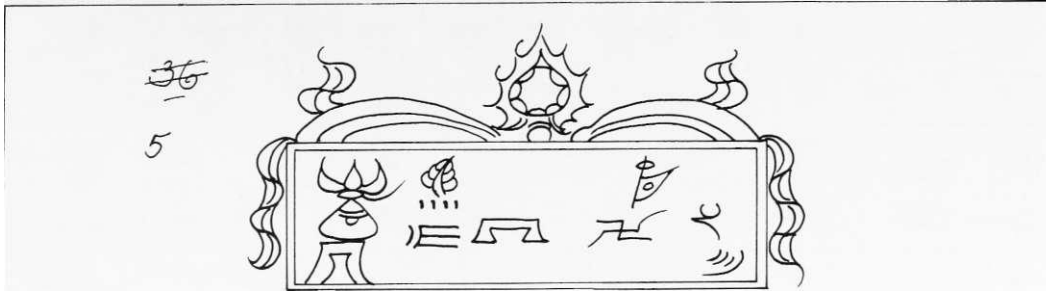

"*nr; - HS.OT-. SOZ/VZ.SZO^B. Hat- la-Uü k'ö. Khya-zher- ssaw 990 t'ä-^hü.gH.

WEISS AUF SCHWARi BLATT T***-

1111

		0	0 TV 7 K

HS.Or 5Q2,/ft.g3,0?B. BLATTE->>'



% 3

V > r -iE?

#~ ^ %\%; ;
 »ff
 0

D



11 >
 IT



1



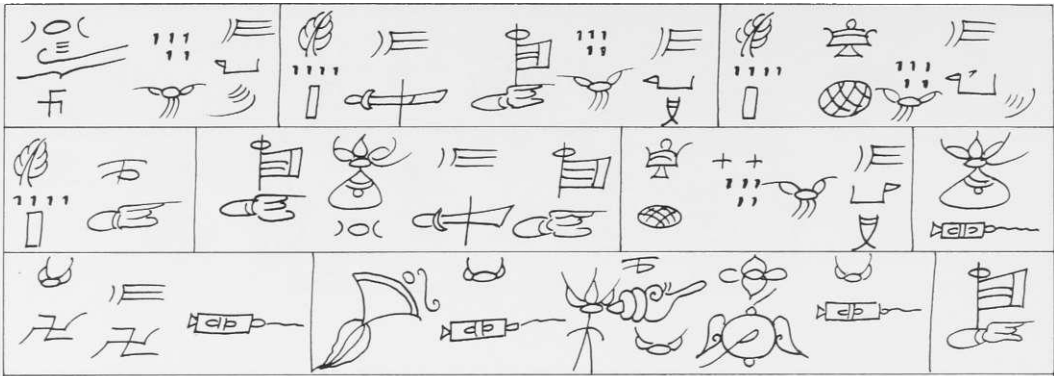

Hs. Or. 502 / R. 8207 B. BLATT 3^{r-v}

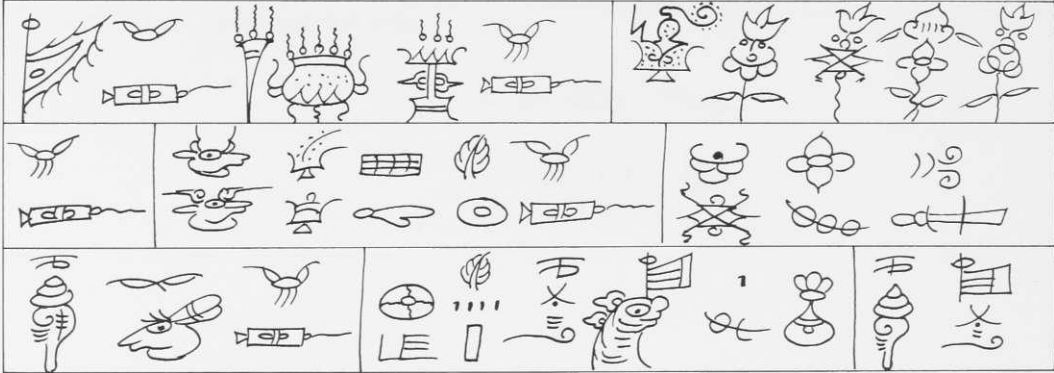

Hs. Or. 502 / R. 8207 B. BLATT 4^{r-v}



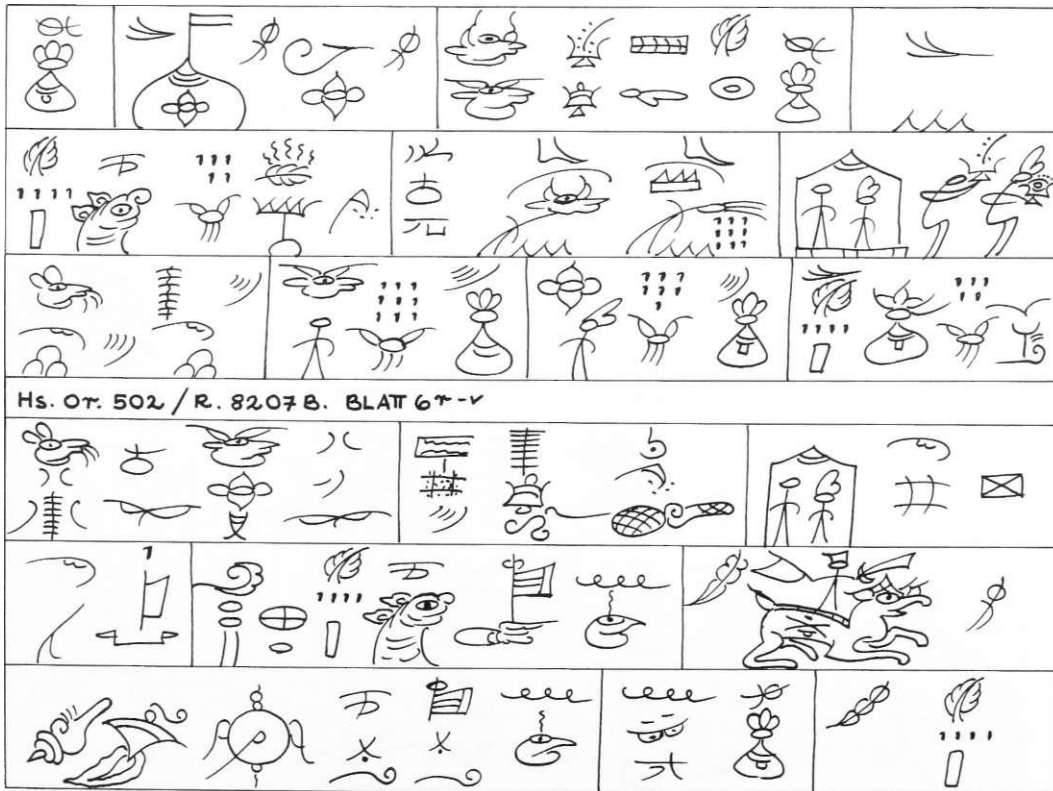
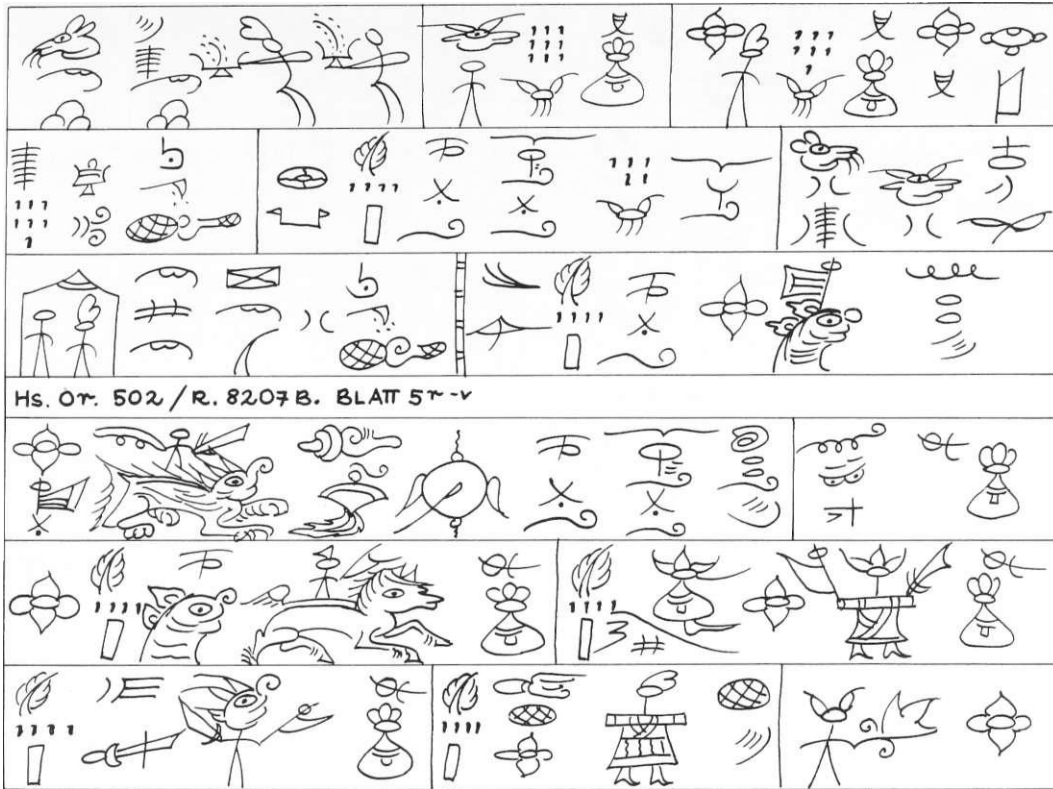

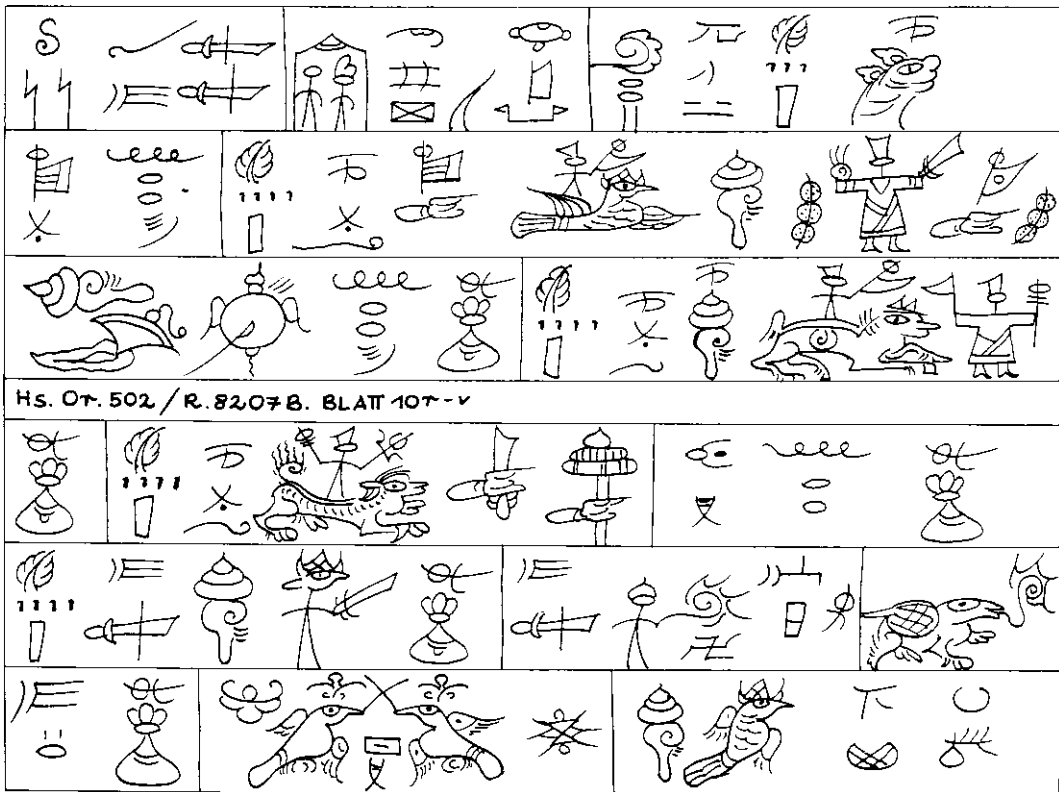
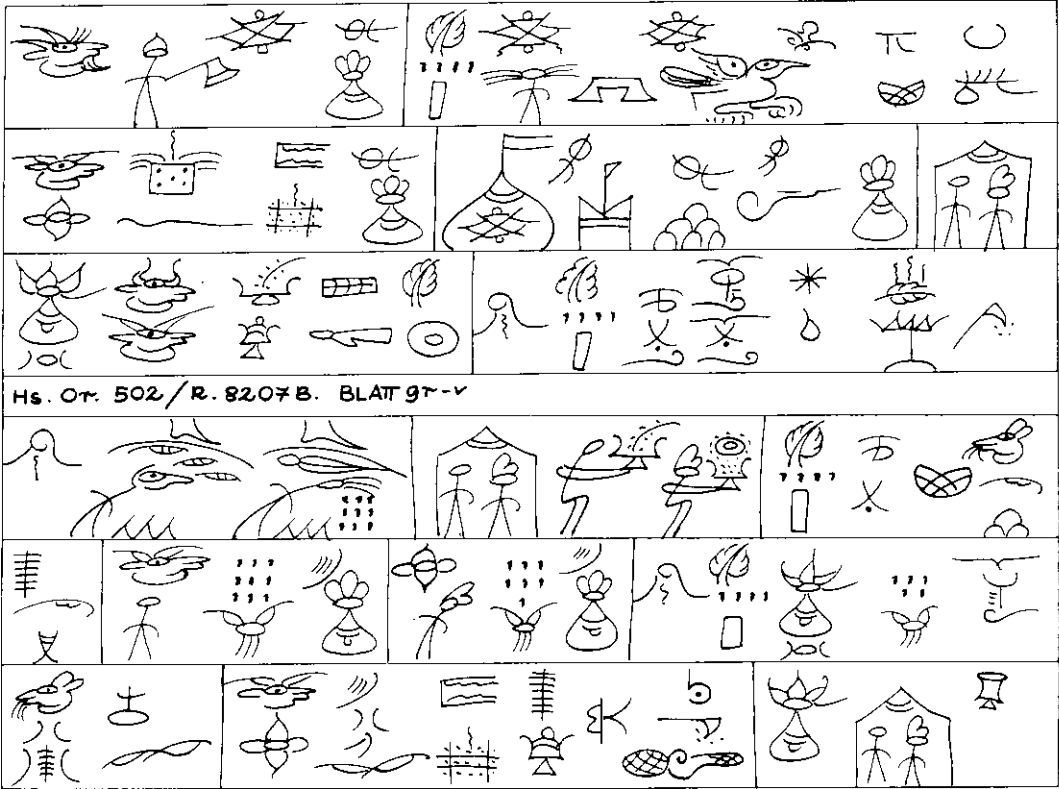



9



7^

__i_n

6

HS.01-. 502//ft.82.0YB. BLAST 11 D-*

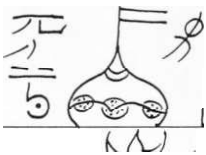

7 a



lii
111



I S I

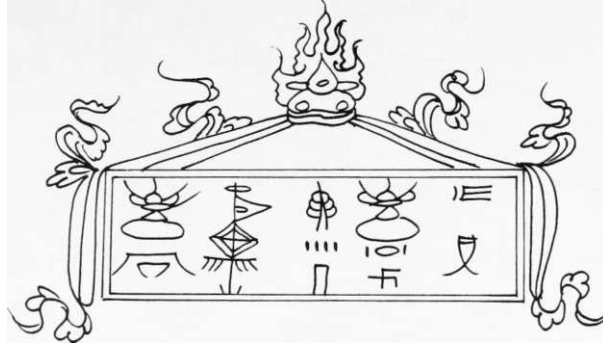

xiii^e - Hs.OT.sim. S ^ / B . ii ^ L Horla-llü. fco. Khya-zher- Bpö-mbö ssaw. BUAT

ß.OC)d:

D •€



Ä L|=f



Hs.or.sim. 584/R.T171. BLATTZ^-v



X
111
11

)i
"

X m

11->

4
-in

| a

irr
11

X

1 1 t) l z — 1		ü w	
			lit/ - I J - 0
HS. Or. Sim. 5 § 4 / R. 11 ^ 1. BLATT S''' •'			
			^ = ^ ^ - o — M T 7

Hs. or. sim. 5S4 / R. H ^ I. BLATT tff-v			
I	ö	l	p # p
			p e s
			(l ^
l g g > ^ ^ ^ ^ < ^ p ^			* &

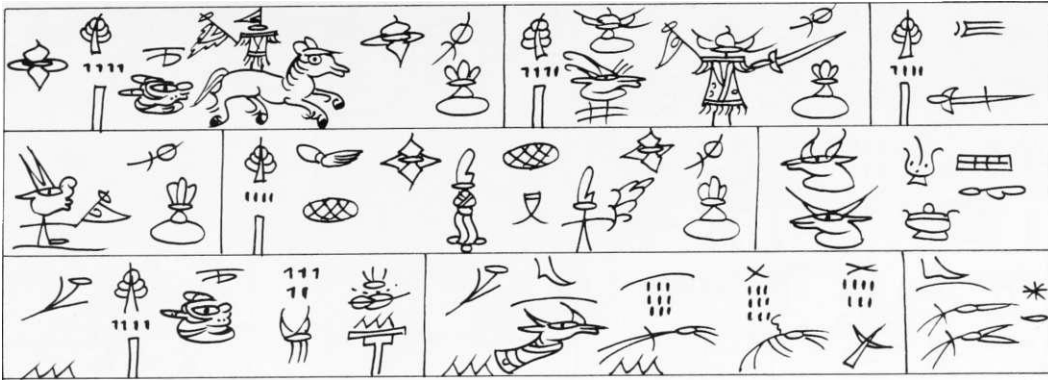

Hs. or. sim. 5 * 4 / (? . B L A T T S T - - *



6h



Jl X y jtllr

i11
in

111
lt.



3 § C

5 5 * "

i

VC



im



TTI crises ^



2 \$



HS. OT. Sim. 5 84/«. 11*1. BLATT fe'

1

•M

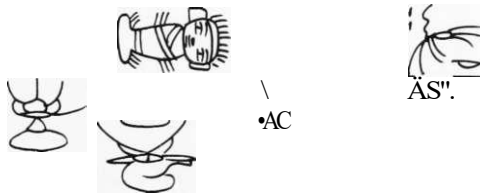

•AC

AS".

9 f ^

-in
11

111
11

>

x



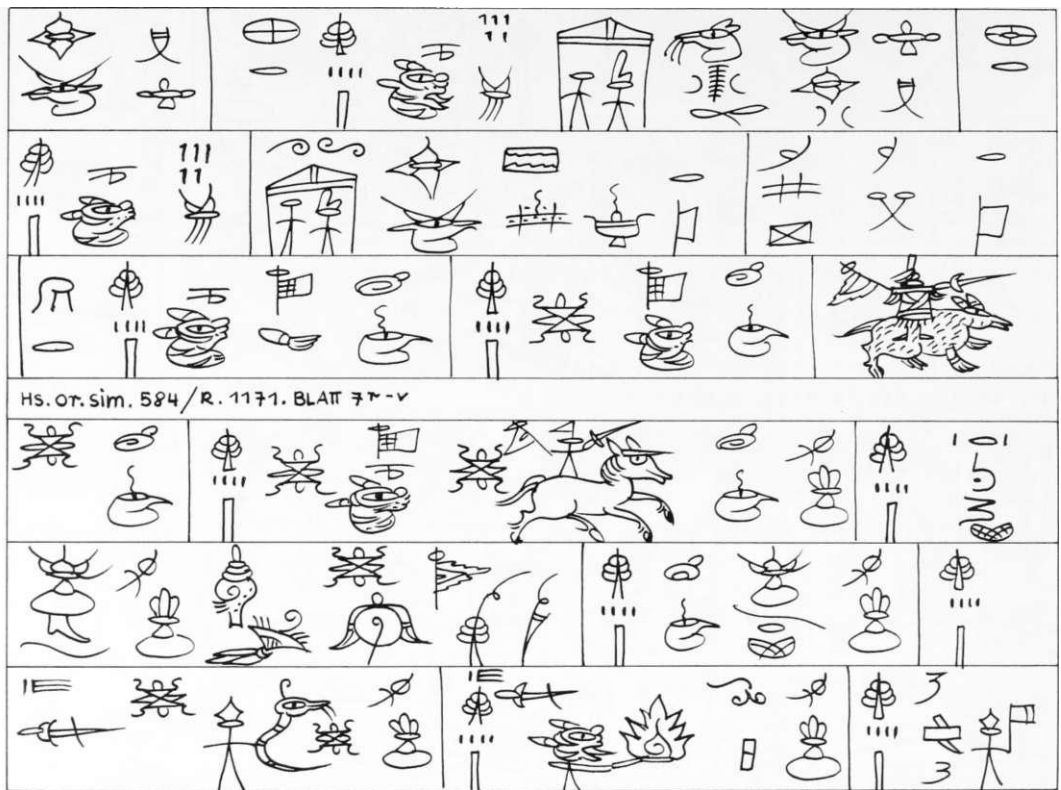

		v i	
		E B B	11,1 fl ^ T
HS. or. sim. 5S*1/β. 1171. BLATT 77-V			
			<i>fit</i>
	i r r	.-x	*

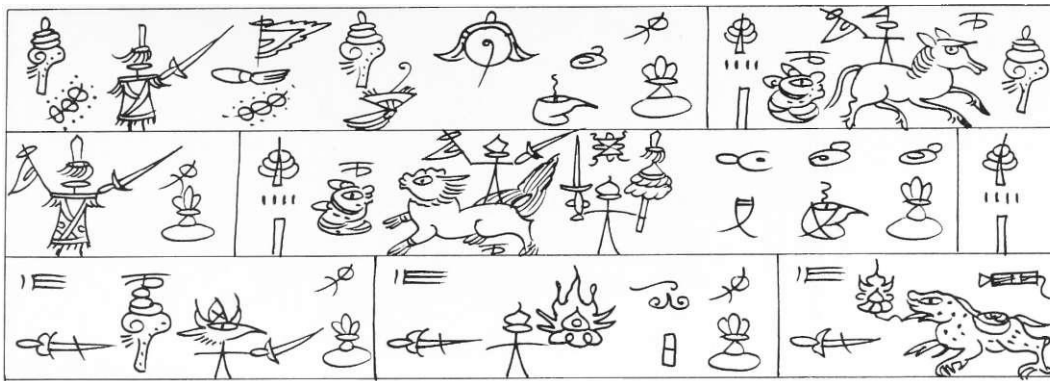

Hs. Or. sim. 584/R.1171. BLATT 9r-v

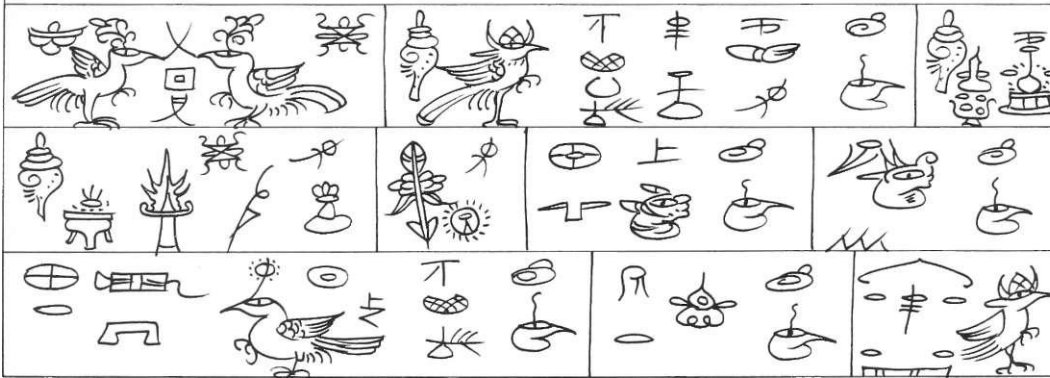

Hs. Or. sim. 584/R.1171. BLATT 10r-v

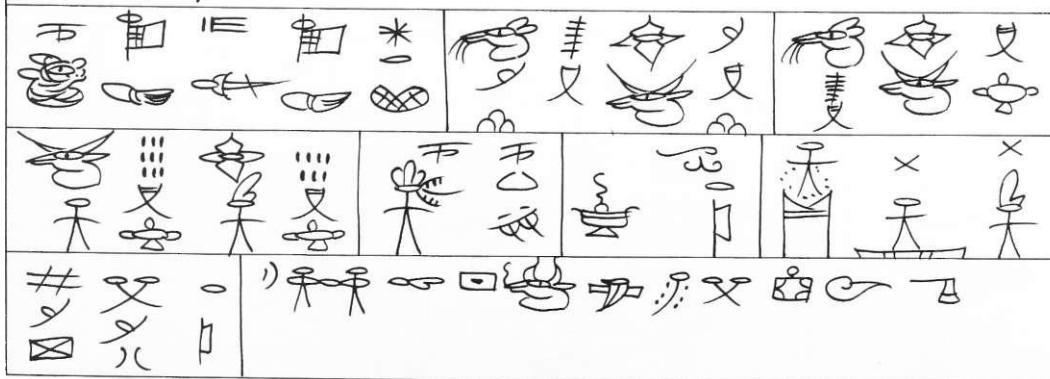



BLATT 11 > *itf*

BLATT UV

Hs.or.sim. *58h/fl."V1*1.* **BLATT 1 1**

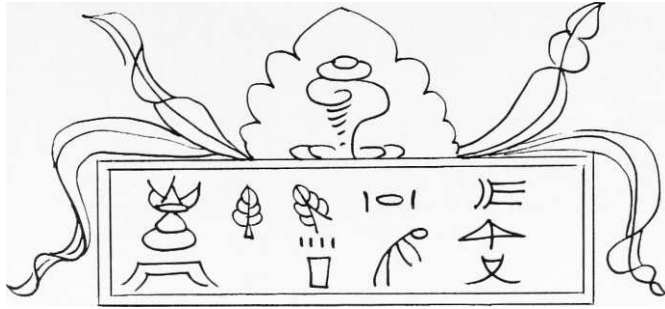

xn, 93, Dp, oder-

XIII, 9?-e - Hs. Or.5Q^/R, 82.i1 A. H&r La-Llü kg, oder.- Dto na Kö. Khyü-zher Bpö-mbö

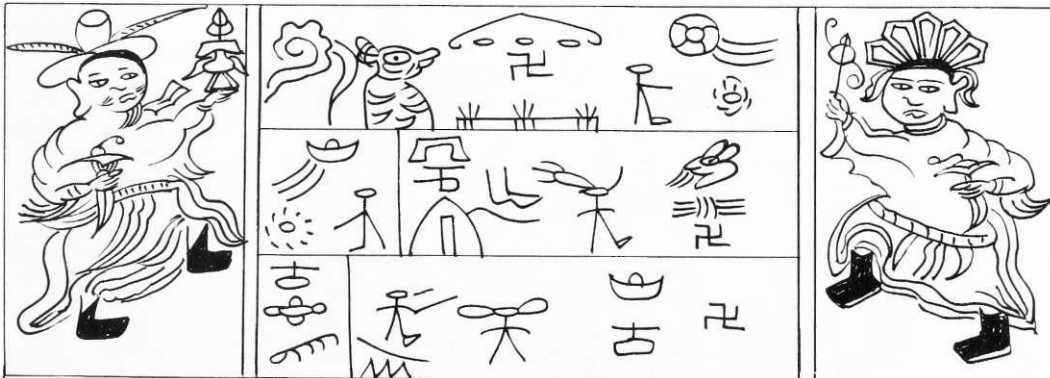
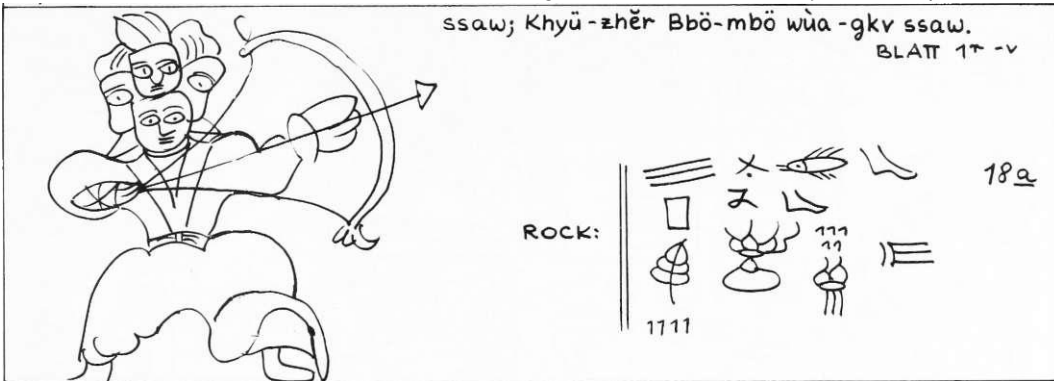

HS.OT.- 50=f/B. ?i,HA. BLATT



-j? >

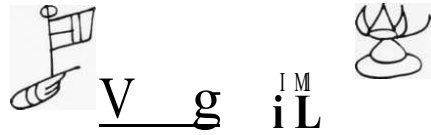

III

V g iL

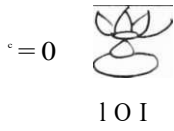

HS. Of. SO^R.. \$2,11 A. 6LATr3''-'

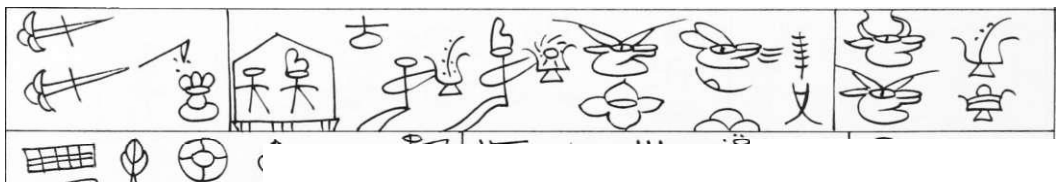
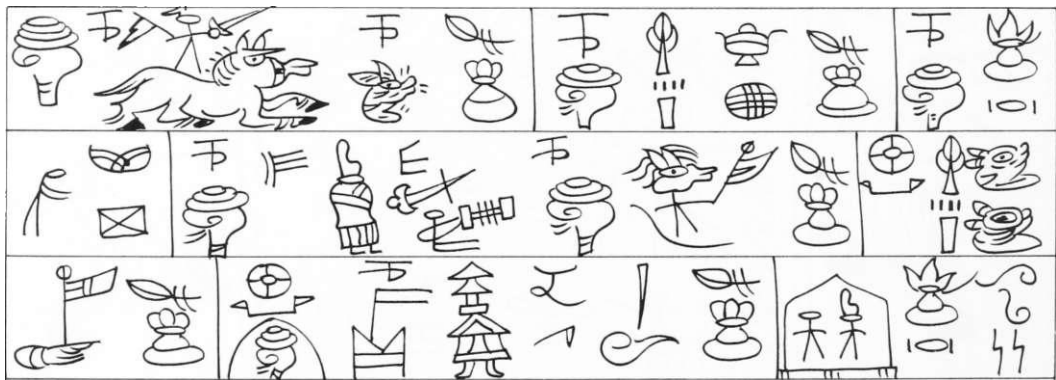
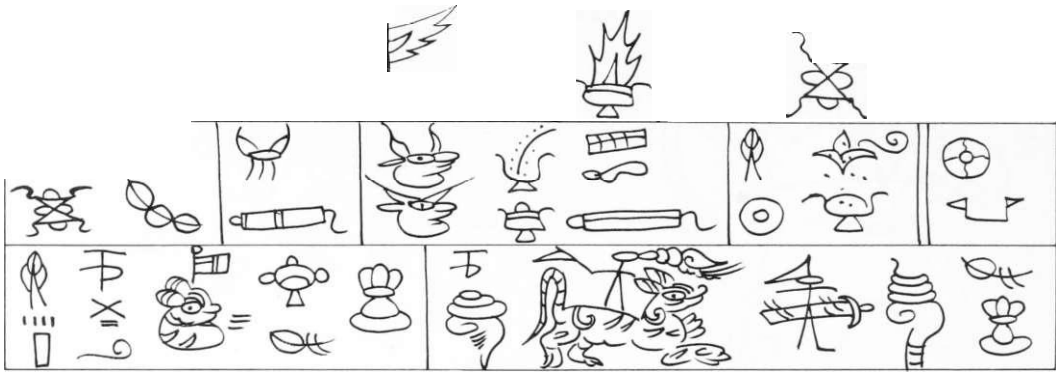

III ^ py

iii
1



Hs. Or.. SOT/R.. 82,11. BLATT 5 ^ - y

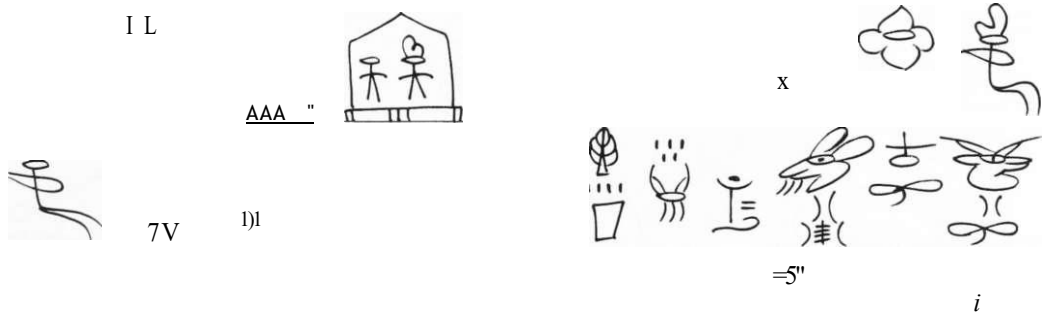

Hs.Or. 50 T / & . 8*2/11. BLATT G ^ ^

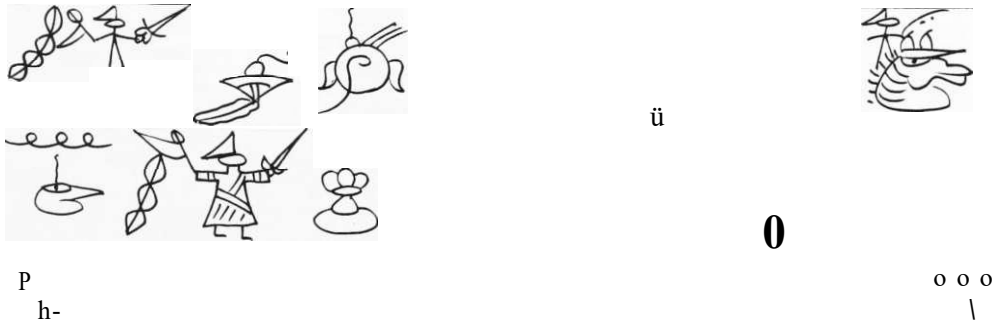

	<i>U</i>	li²-o
		V/t Icrü ^3
HS. Or-. SO ^/B.S-JLH. BLATT		
IHIMII — IIIIII III .		
[^] D	1 *	Mio[^]ii-

		"fj
Hs.Or-. S O r / B . 92.11. BLATTffT--V		
/	1 j!L§5 • (BIS, ° Je	T I ^ -vo**r



IL

IL



• II
• II

7

E I 3> fr p

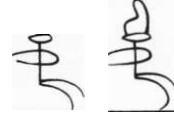

Hs. 0>.50=J-/R. S*2/r1. BUAirgr-'



	f ^ ^ ^ ^
	n
	j ^ ^
HS.OT-. 5 0 ? / B.. M/M. 6LAF '10'' - ^	
f AI	~0. — 4
^ / I M	
T3L7	* & ^ *

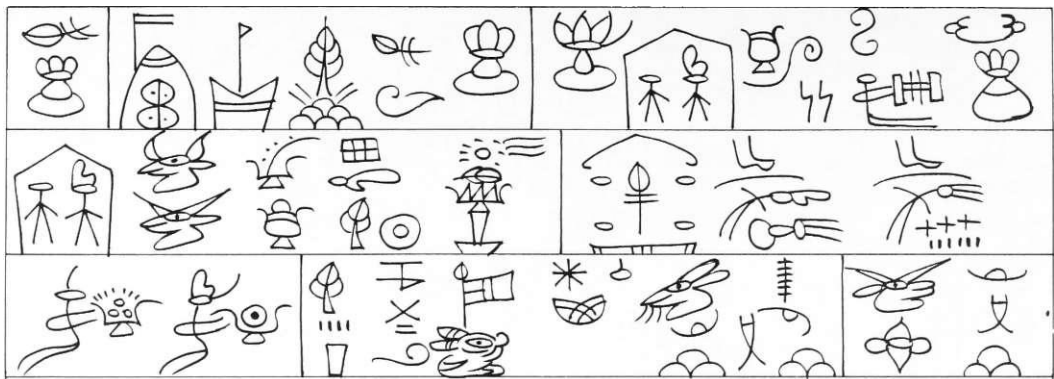

Hs. Or. 507/R. 8211. BLATT 117-v

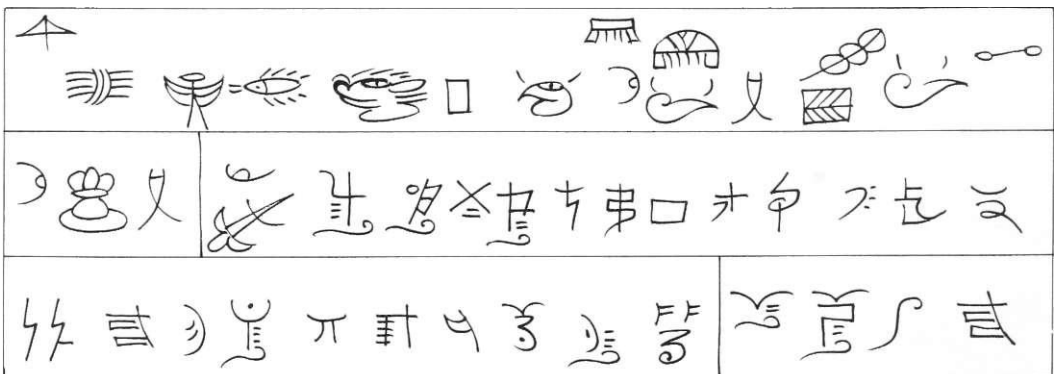
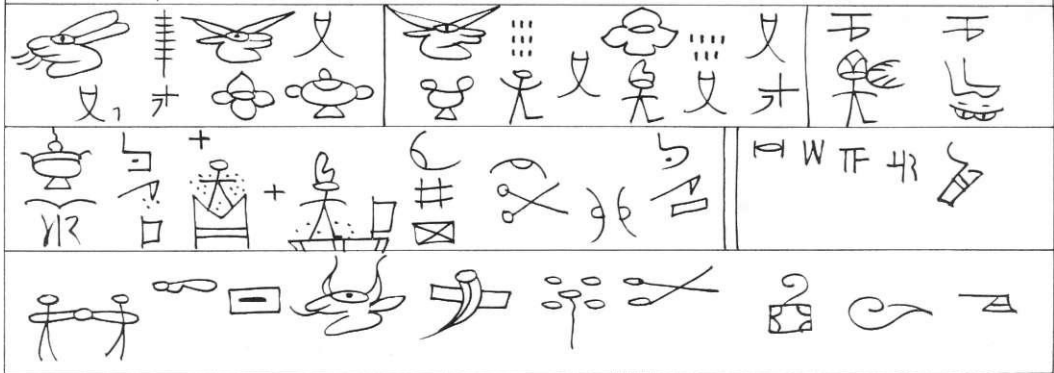

Hs. Or. 507/R. 8211. BLATT 127-v

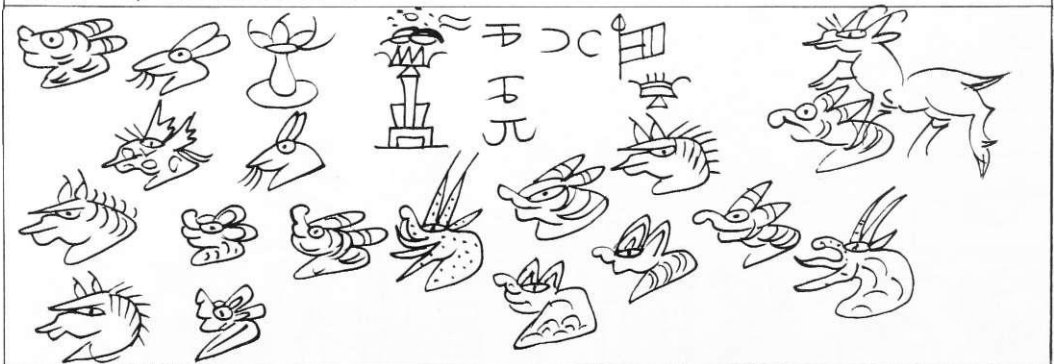

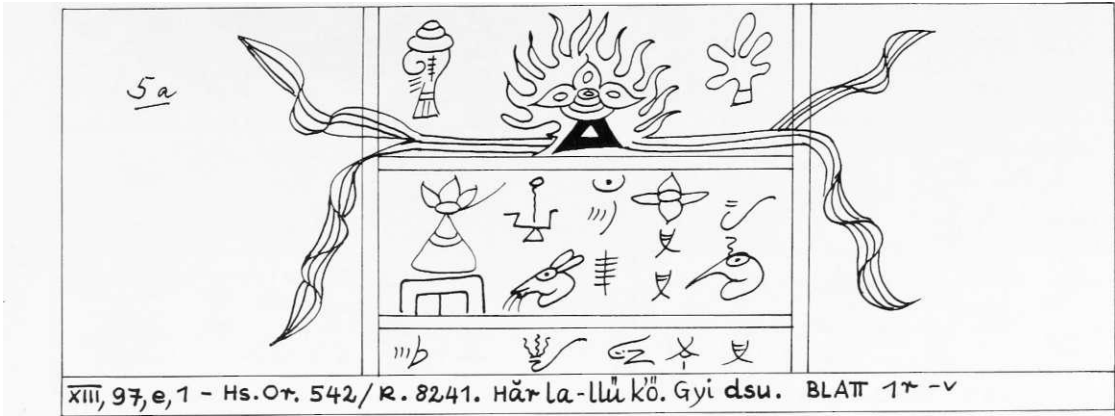

ROCK: ss = c s r p r LL
 B & *

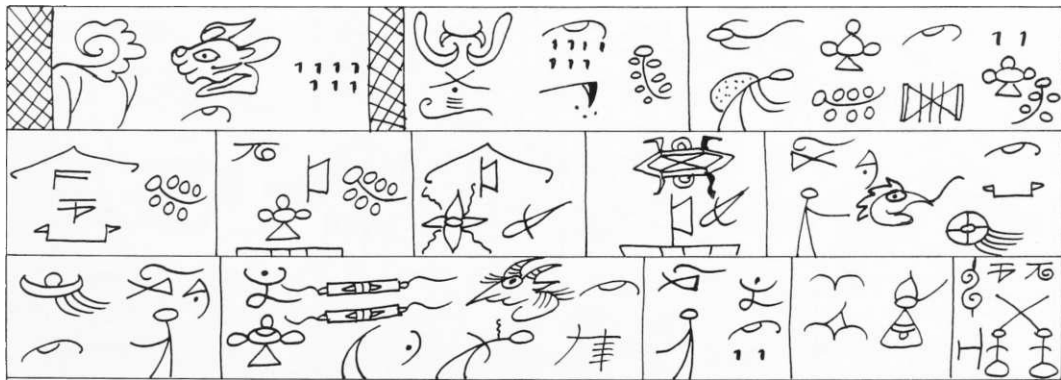

Hs. Or. 5i+Ä/R.. £2,*fl. BLATT



9 - i »l

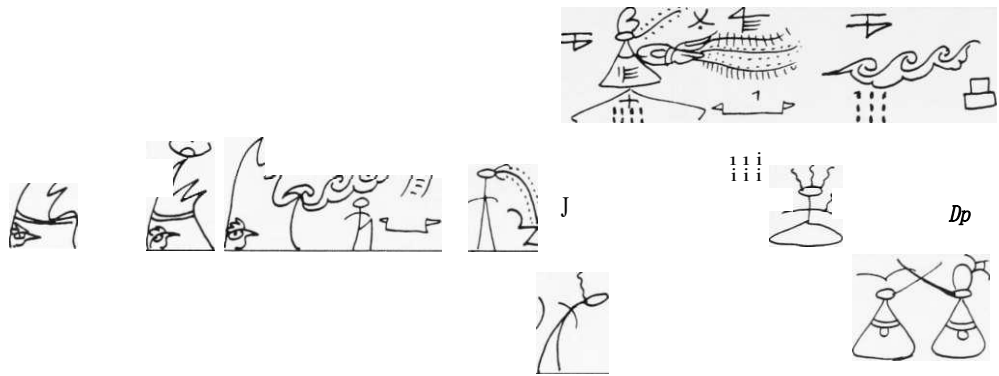

Hs.Oy*. 5*42, /<<. ££41. BLATT

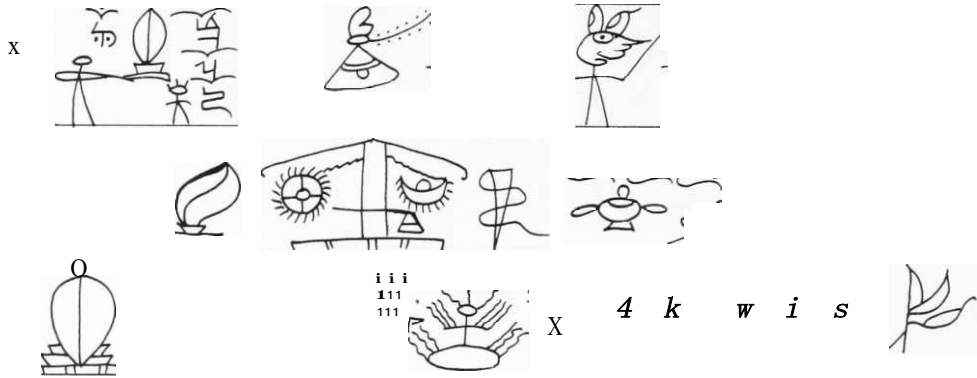

			l v ^ « s

1



Hs. Oy. 542, /fc. 82, 41. BLATT 4 ^ ~

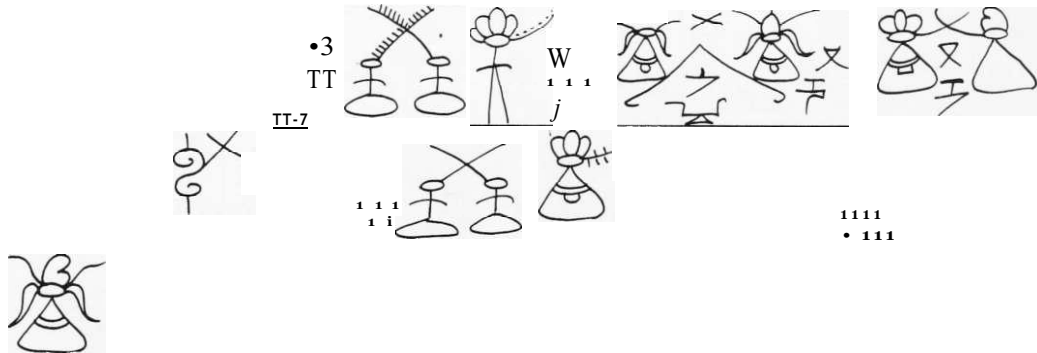

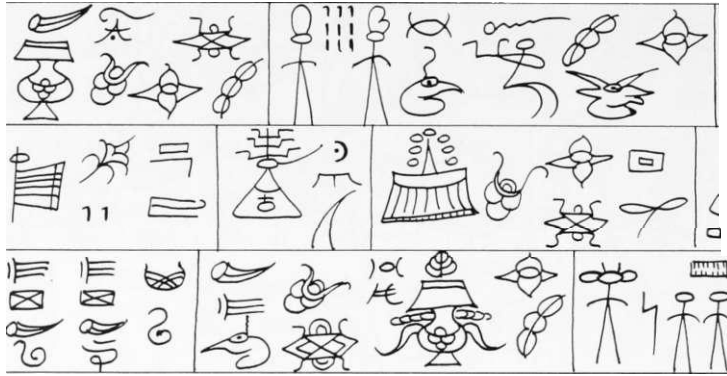

1 1

•v'

TS h

HS. Of. 542, /B.

BLATT 7-v

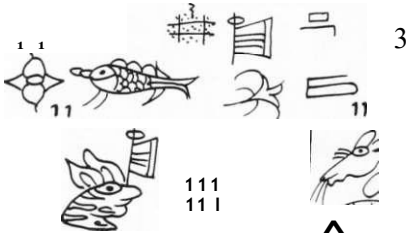
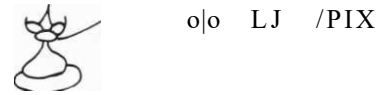

HS. Oh 542/ /•

BLATT 8^



	1	3

HS. Or. 542//B. 8*2/41 • BLATTE ~'

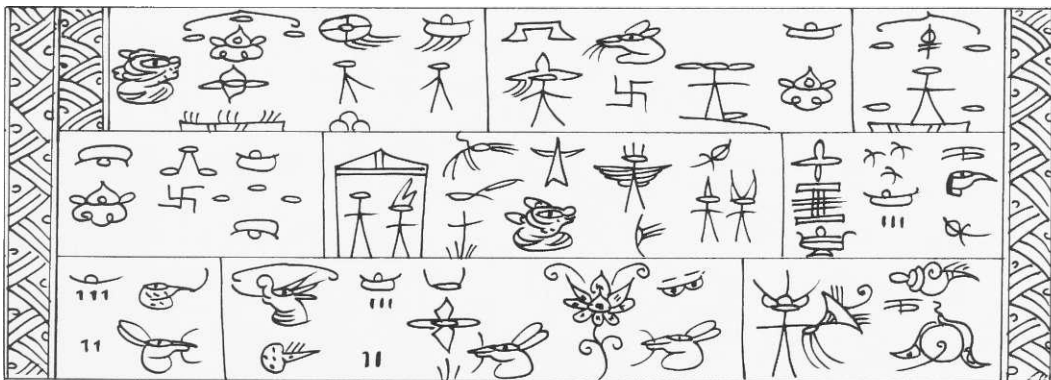
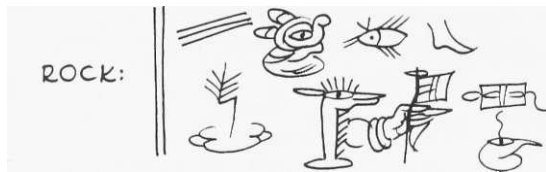
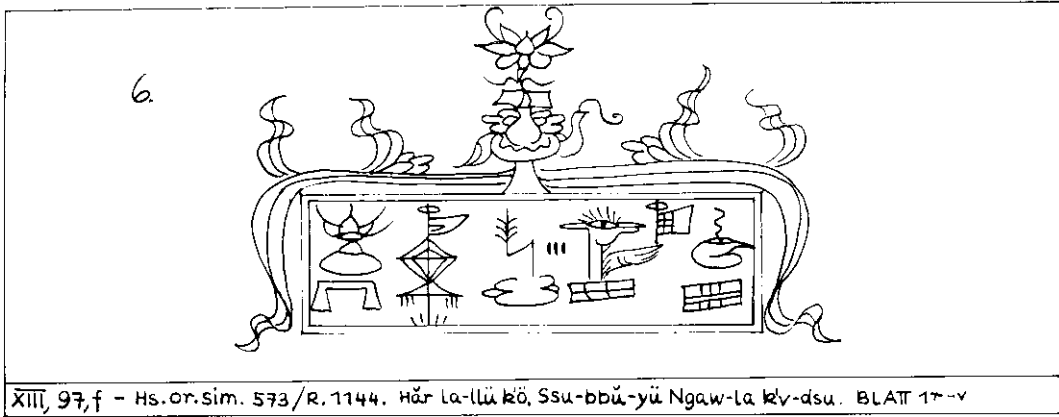

Hs. or. sim. 573/R. 1144. BLAT 27-v

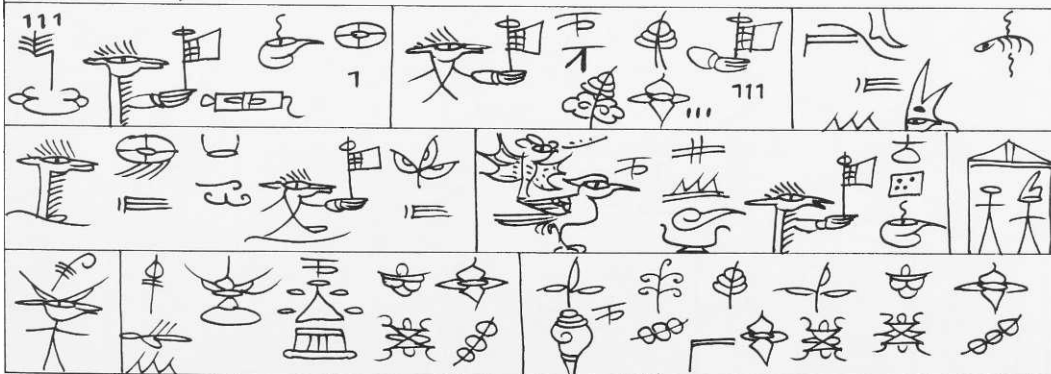

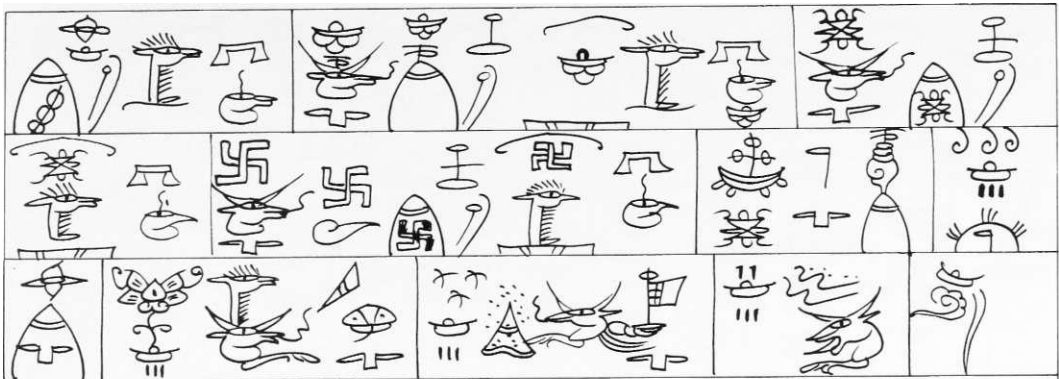

HS. Or. sim. 573/R. 1144. BLATT 57-v

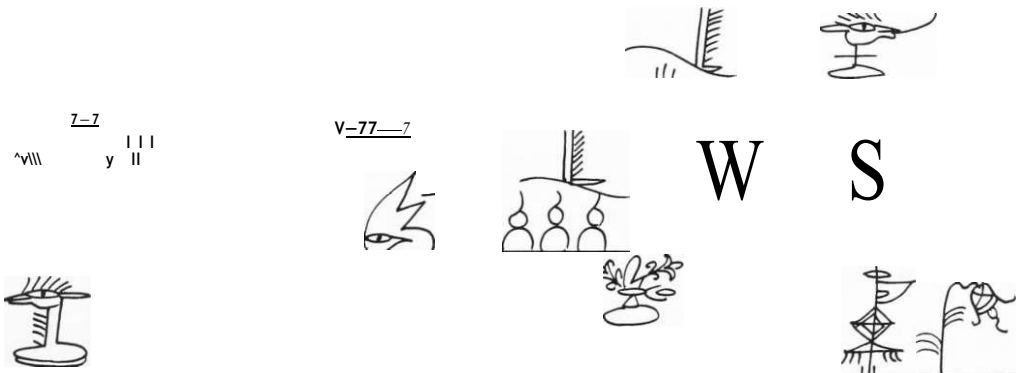
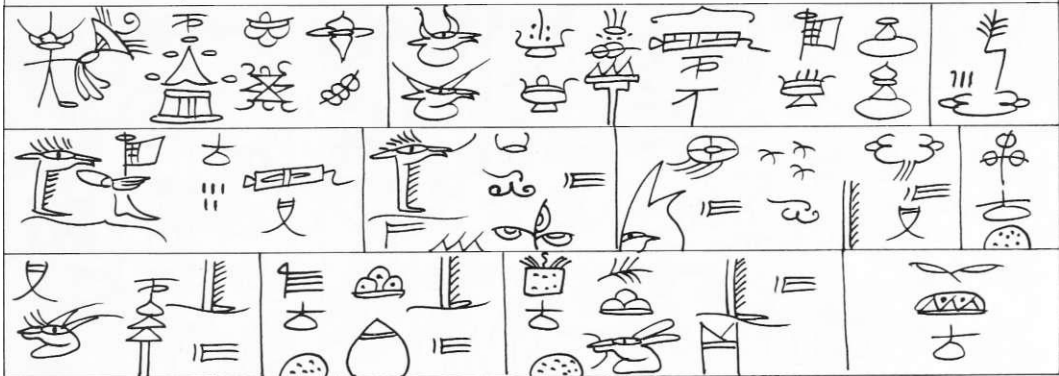

HS. OT. sirin. 5 ? 3/B. 111*4. BLATT <0T"

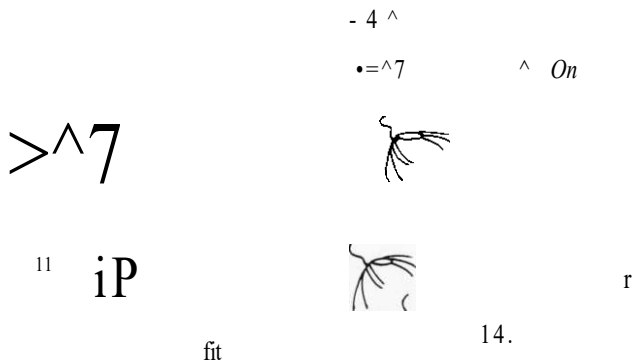
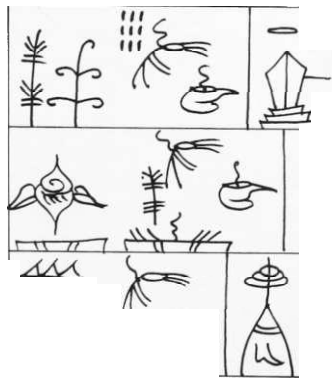

J t #		IM	
li; ^ ' •		^ - T C <i><>ä V^=j	^^^
		1 * : : ^	
l-n-T7-7			
HS. Or.Sim. 5*3 /R. 1144. BLATT ? r - v			
			k ^ > 177t
		1	

<p style="text-align: center;">- <u>P</u> Ä <</p>			<p style="text-align: center;">* TU</p>
Hs.OT-.sim. U M M . BLATT S ^ - V			
		11 / A	
^ JAW : s ? **		t t	1
0 r		v Ä 4 -	



Hs.Or.sim. 5}3/R.114H. BLATT 3f-v

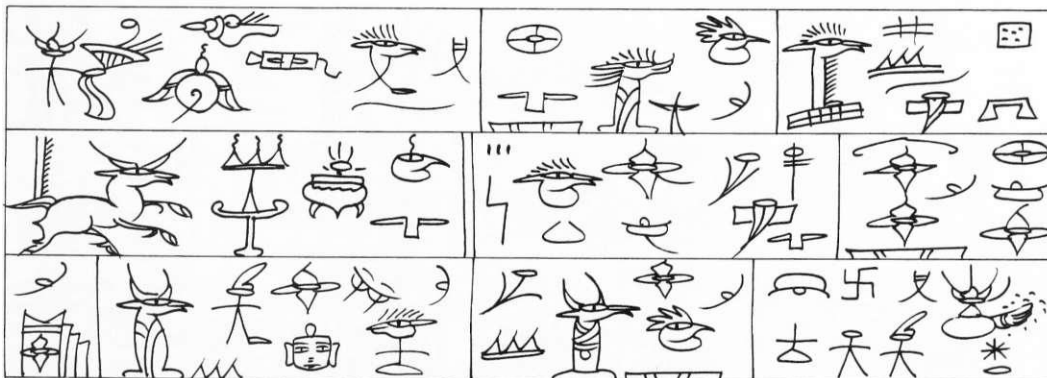
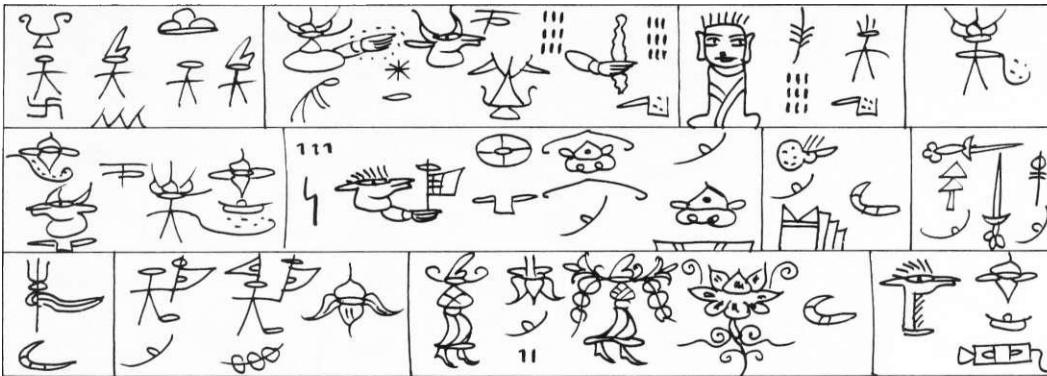

HS. OT-.sim. 5^^3/R.1144. BLATT 10^



IST



y



AM



rr-i

AAA

Hs. or. sim.

BLATT n^



IM
in
in

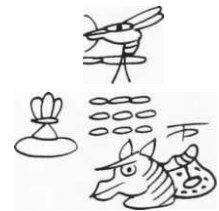

TT-1

rn-77-?



HS. or. sim. 5?3 /R. 1144, BLATT 1^"»--'



III
III
II



m
in
in

in

in
in
in



III

III
IM
III

in
in
in

tu
III * 5

III y y in
II y y III y



IM
M
III

III

III



77-I

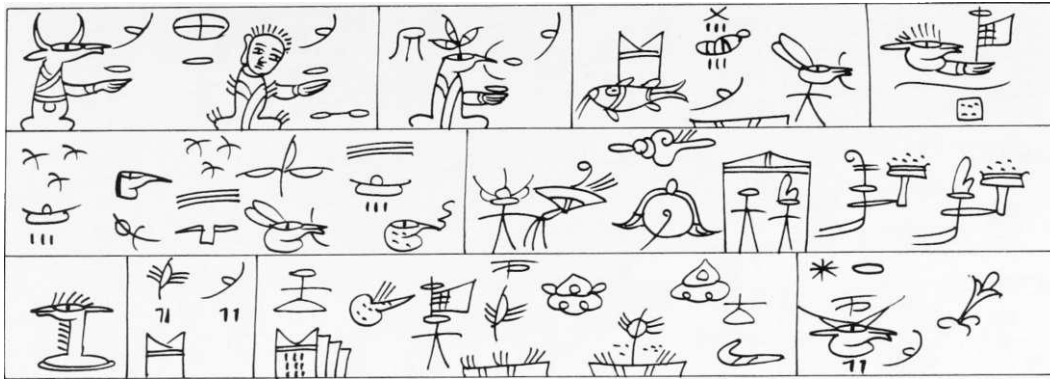

Hs.or-.sim. 5?3/R-1144. BLATT 13'''



1/

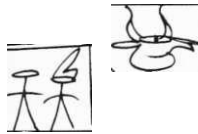

III
II - n

I £SE3-I_-



3 F

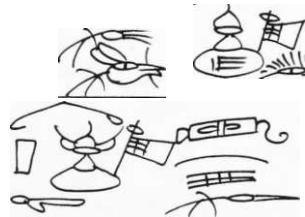

- 4 -

HS. OT.sim. 5T3/R.11H4, BLATT 14 r--V



->ux



"€3



^		®~	
HS. or. sim. 5^3/R. 1144 &LATri5T--v-			
• IM -"	ff	lii	^
			li ^ t-u-
<i>it</i> -®			

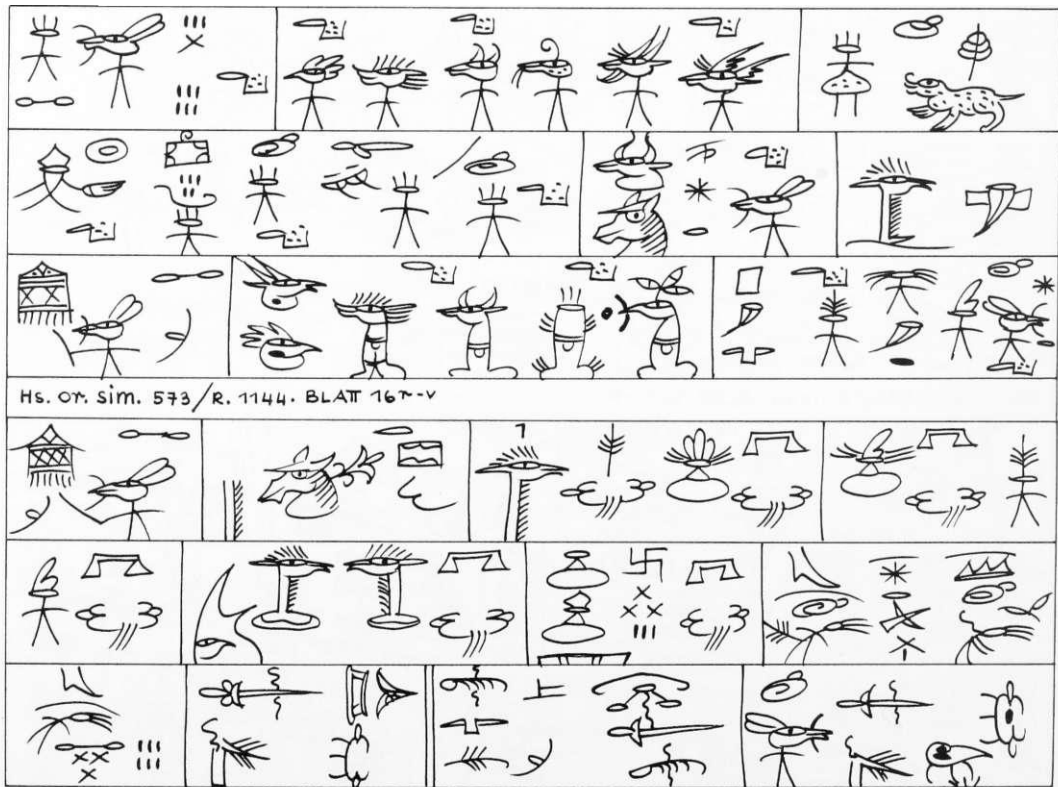

HS. or. sim. 573/R. 1144. BLAT 167-v

U P	<i>l</i>		
	<i>π=77 7</i>		

HS.oT-.sim. e^ä/ß.-iiHH. E>LATT -i**-

ÜR.K5 INAL TITEL FEHLT

Lv-p'er Iv-na p'l. BLATT

ḫTṫy 9?, 9-- Hs.or.sim.51^/B. 50^-5B. Har La-LLü. feo. Lä-ch'ou nolshi; Dtv-dshi ngv-mbu ts'ct;

β-OC k:

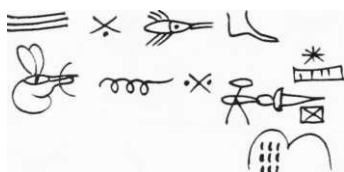

^weiTeß. R.OCKTITEL IH
qiMAL (!)BEie KLEBT UA7D
UAJLESSRÜC4

	Q Uli	3 &	*

hs. OT. &im. 51^/fc. 50^5B. BLATT 2, '-'

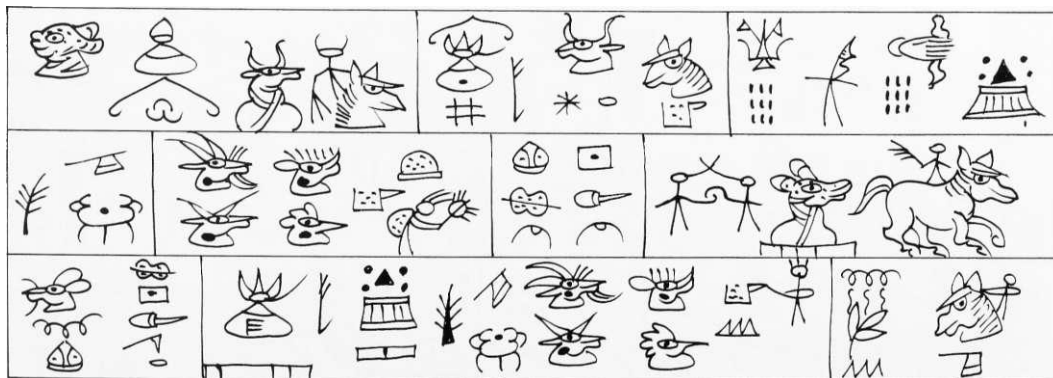

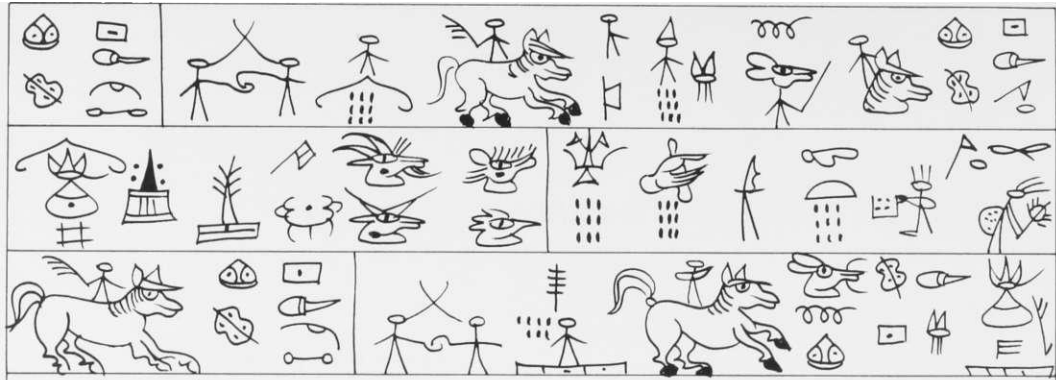

Hs. OT. Sim. 517 / R. 5075 B. BLATT 3r-v

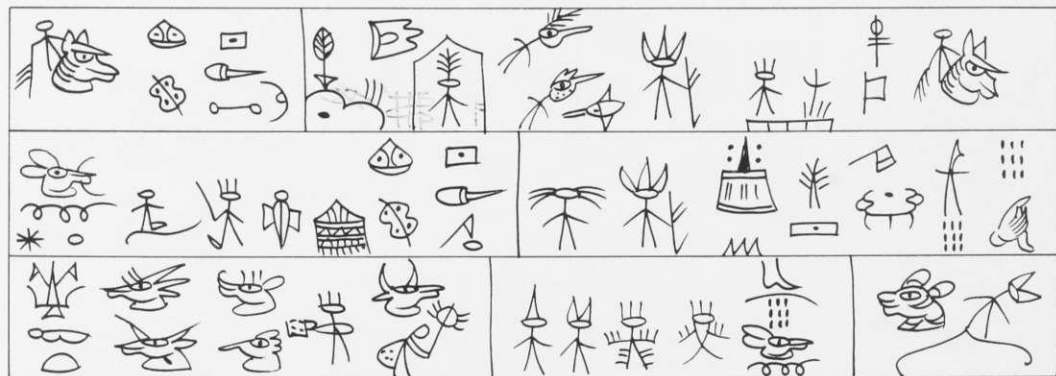

Hs. OT. Sim. 517 / R. 5075 B. BLATT 4r-v

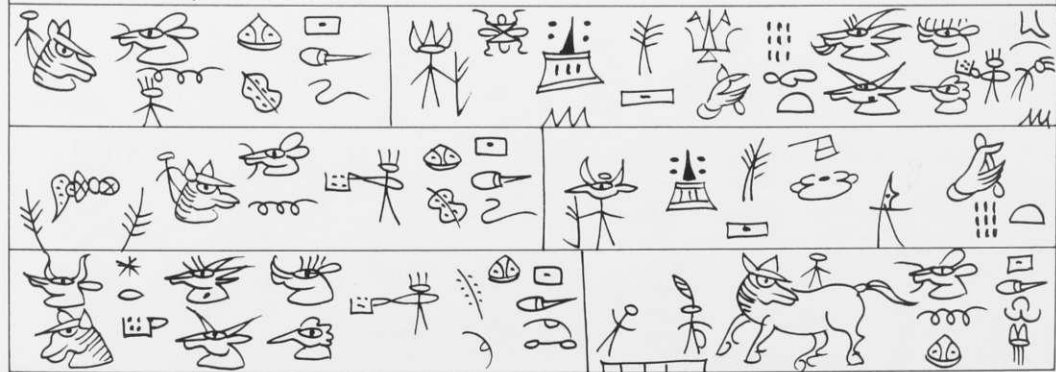

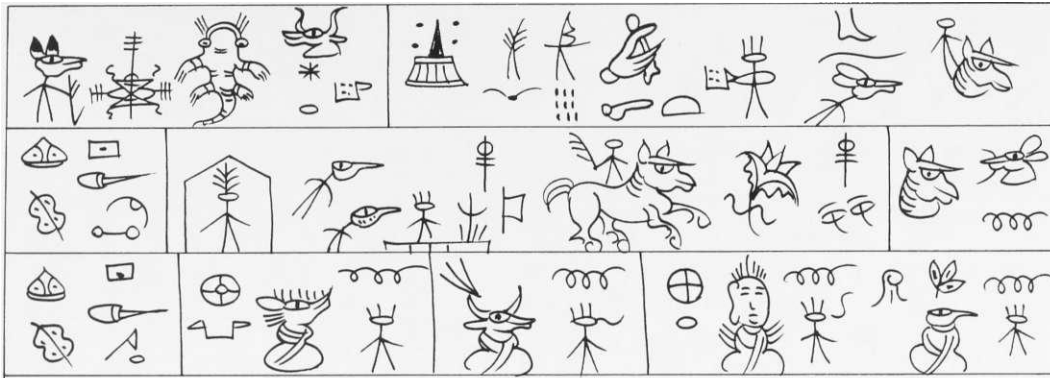

Hs. Or. sim. 517 / R. 5075 B. BLAT 5^{r-v}

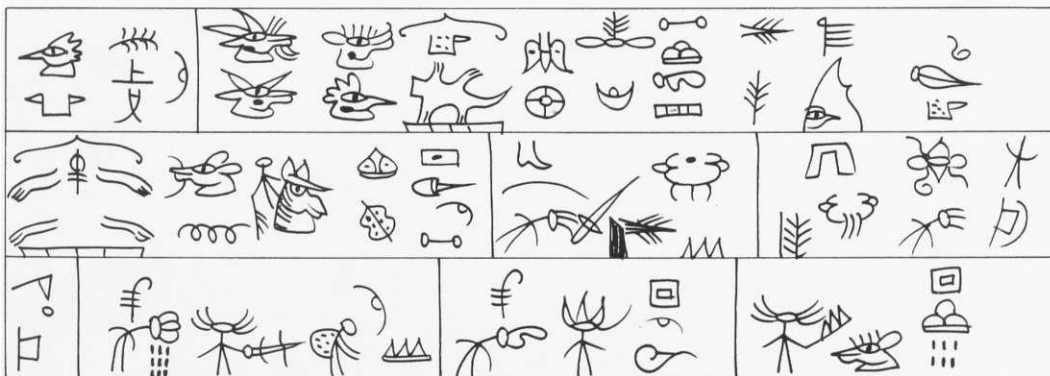
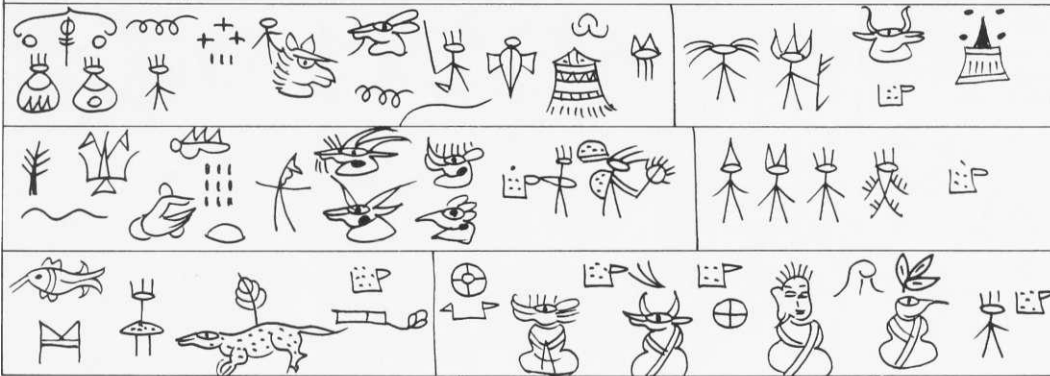

Hs. Or. sim. 517 / R. 5075 B. BLAT 6^{r-v}

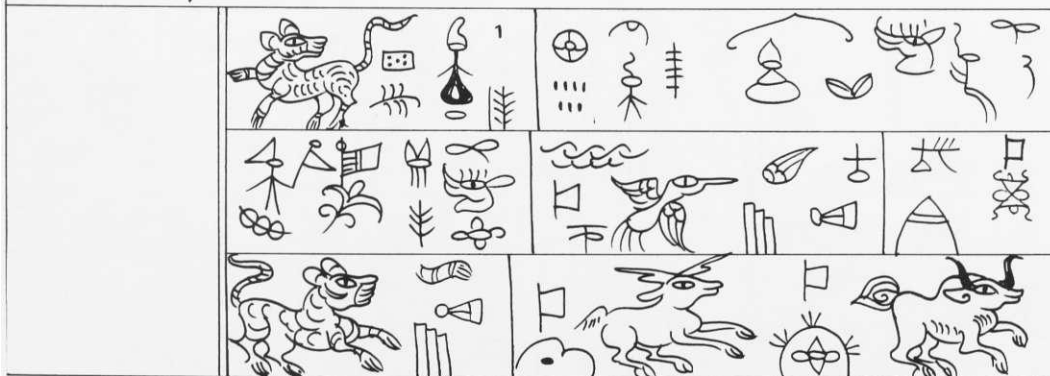

ZrH

66

Mil
I II

/ T 35E.

MIL

3 t

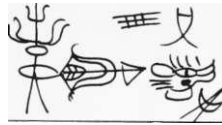

-T--T-
|||
||.

S3



ir'

^ 7 = ———— 7 ^ = ———— 7 ~ Hs. or. sim. 51 > / R. 50 ^ 58. E > .Airs*—*					
1	Vi	<i>fa</i>		4A	XX ^

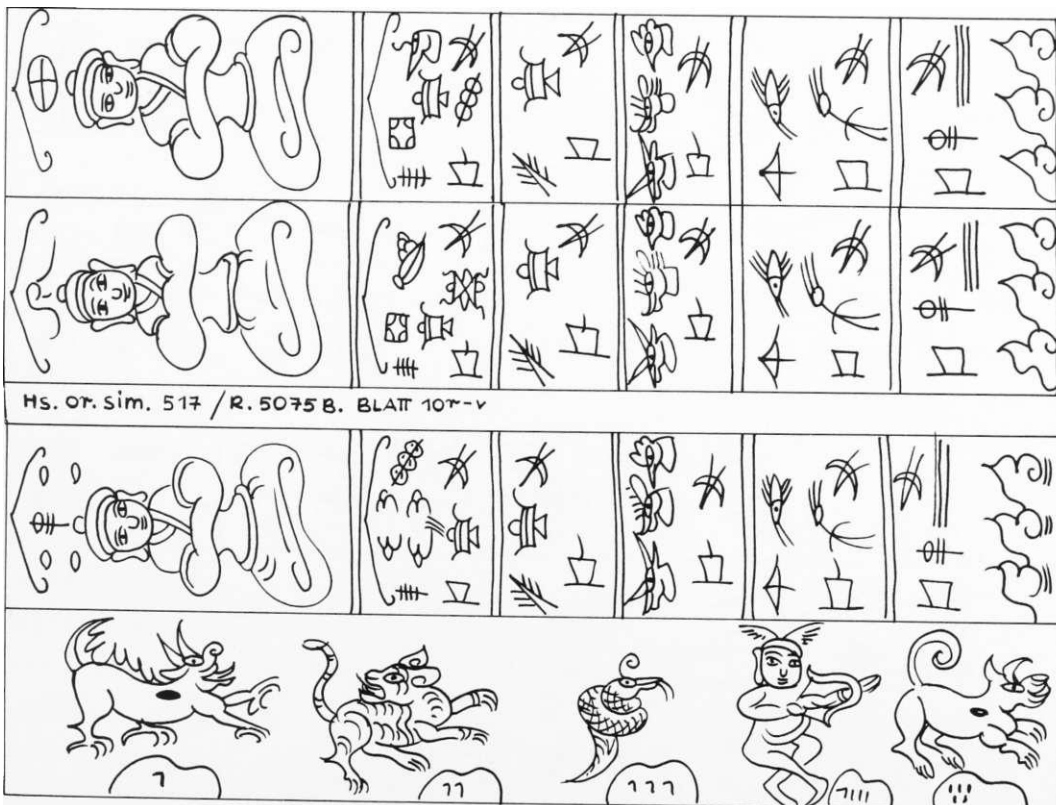

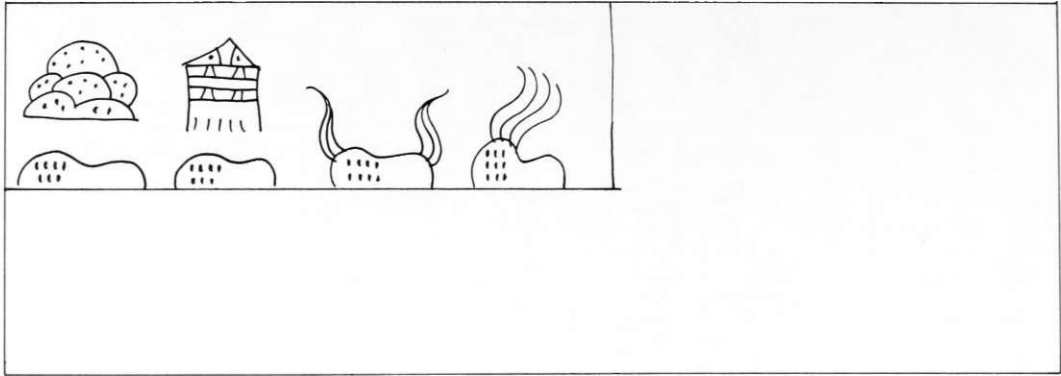

Hs. Or. sim. 517/R. 5075 B. BLAT 11^r

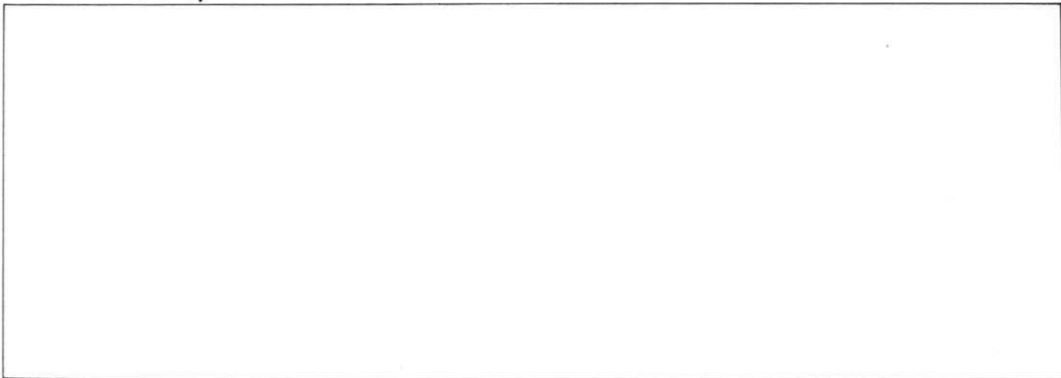

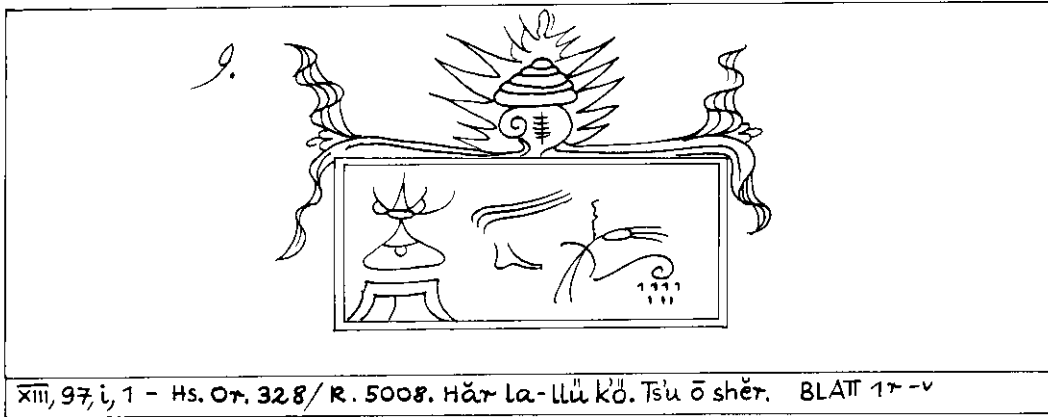

XIII, 97, i, 1 - Hs. O.T. 328/R. 5008. Hãr la-llü k'ò. Tsü õ shër. BLATT 17-v

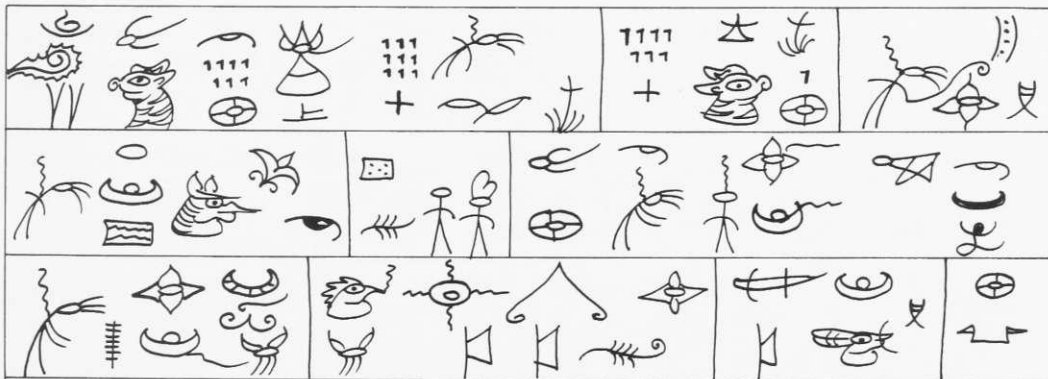

Hs. O.T. 328/R. 5008. BLATT 27-v

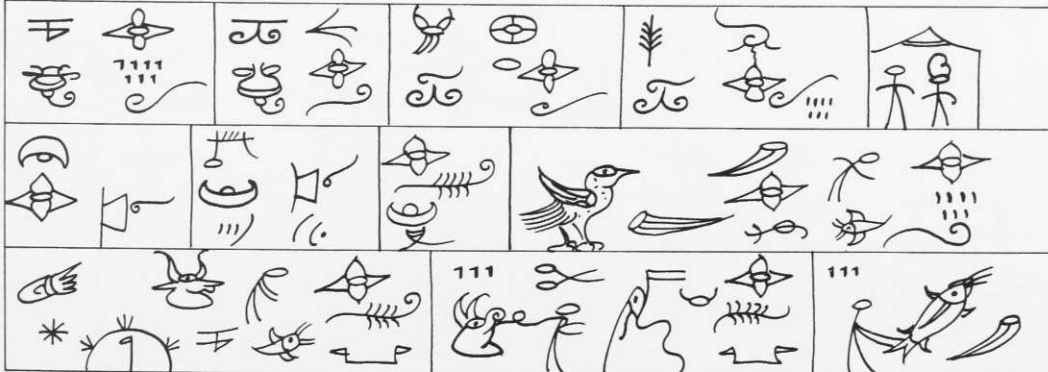

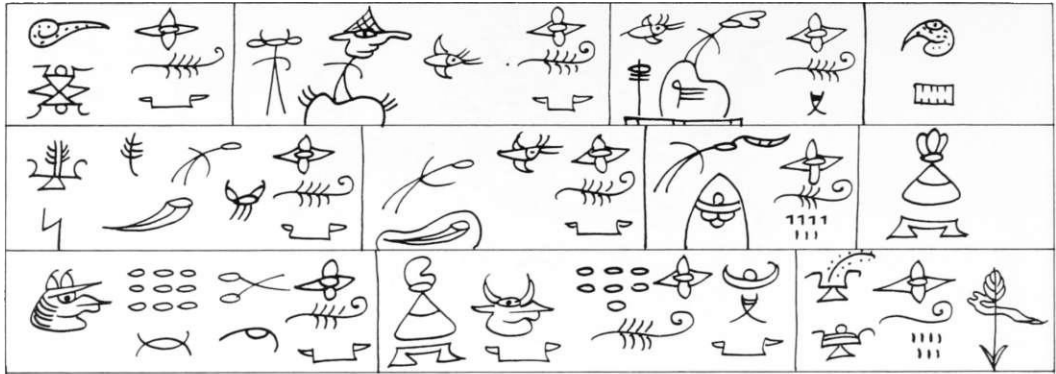

Hs. Or. 328 / R. 5008. BLATT 3^{r-v}

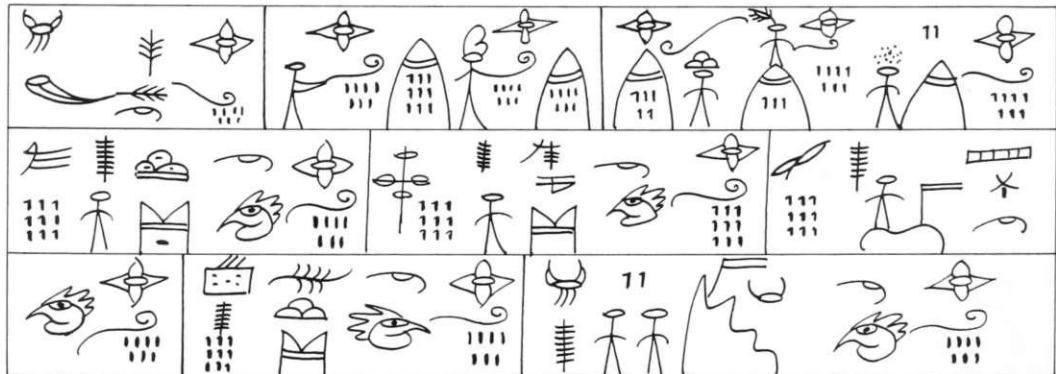
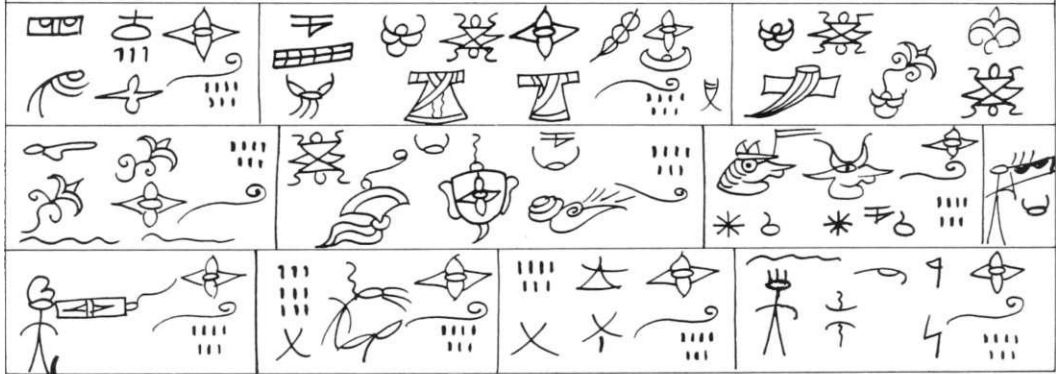

Hs. Or. 328 / R. 5008. BLATT 4^{r-v}

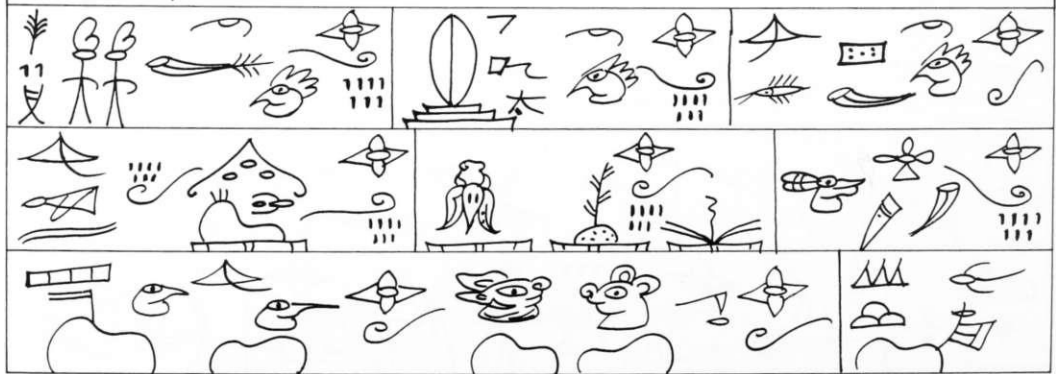

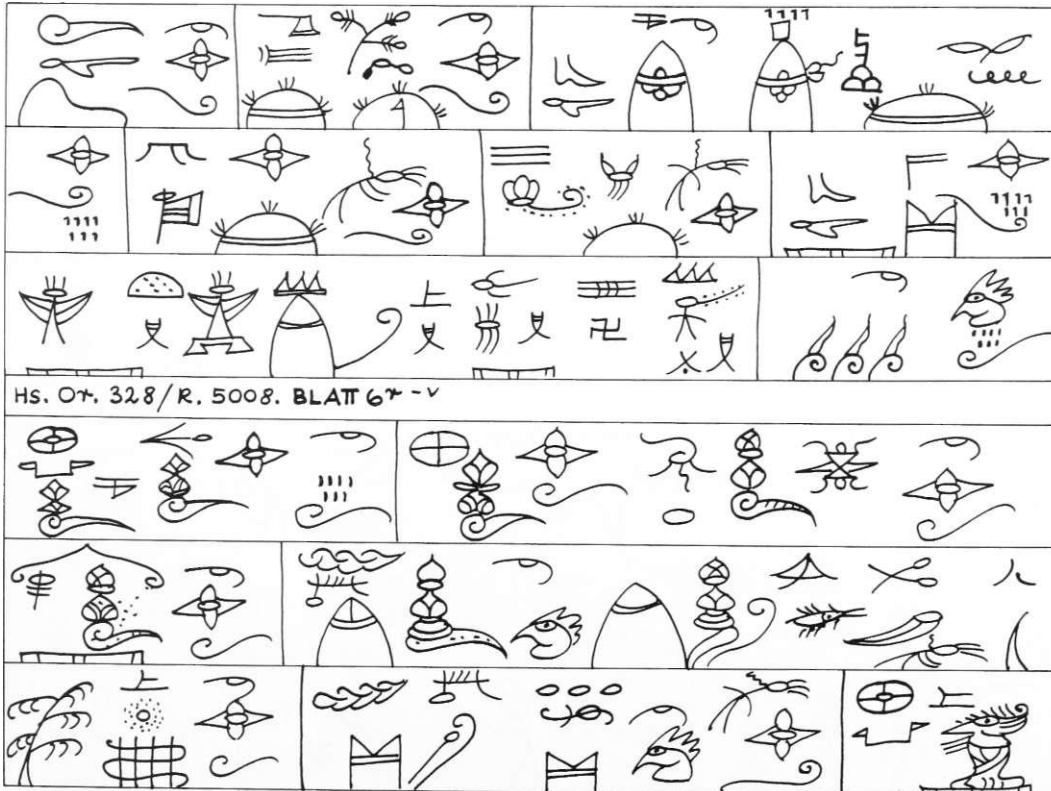
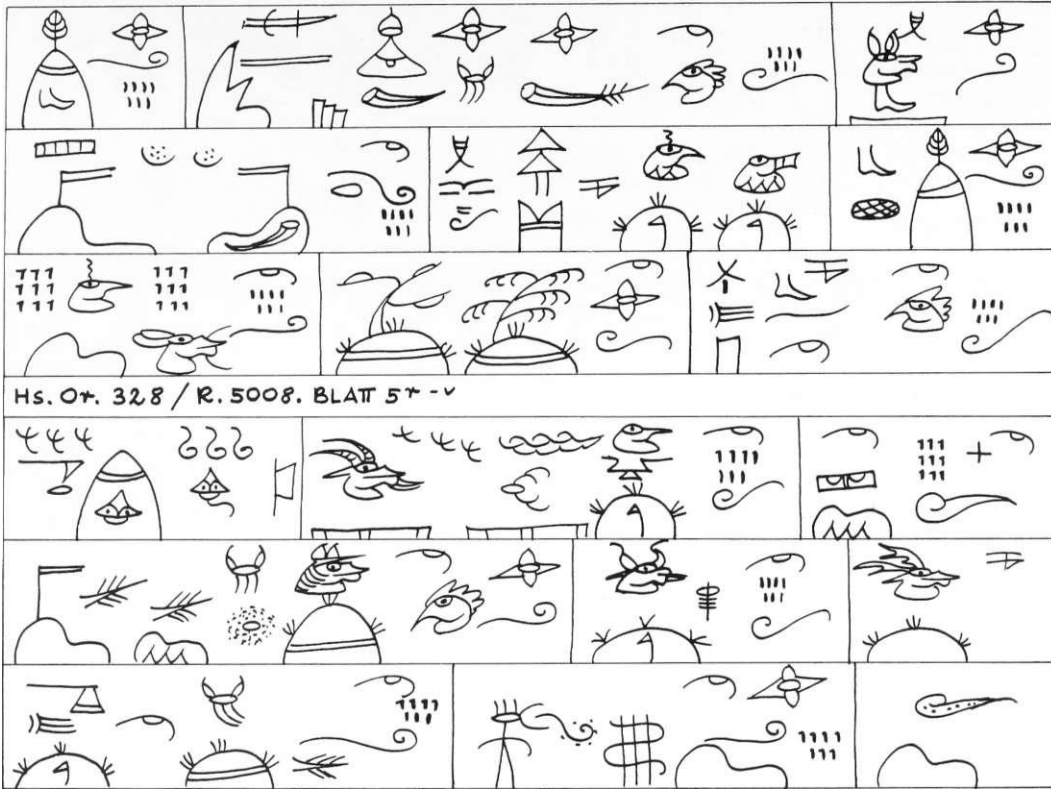

OB. I' ^ 1 hJAL TITEL. FEHLT

x-n ^ 9 ? ^ , 1 - Hs.or. sim. 5-ifo/R. 50 ^ 4-A. Ho.r la-llü feo.Ts'u ö sher. BLATT -I»-V

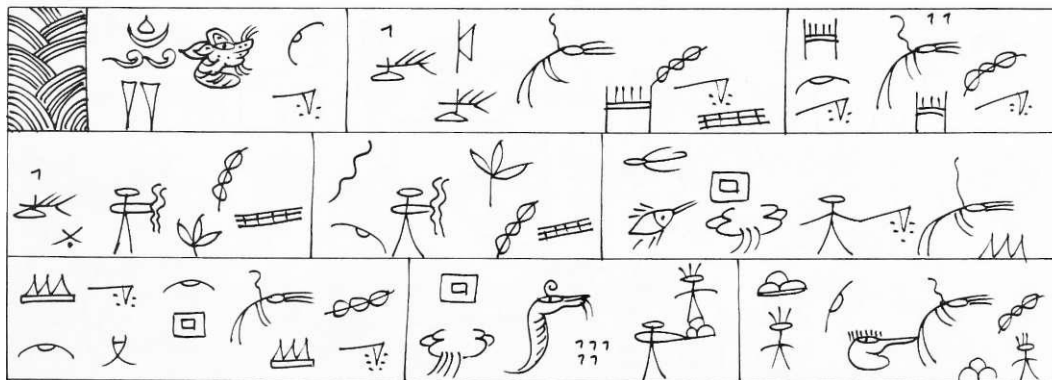
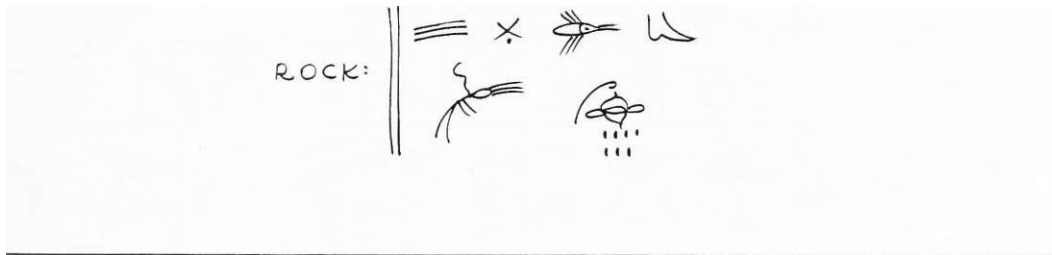

HS.OT. Sim. 51 < o/R.50?4 A. BLATT i r - v

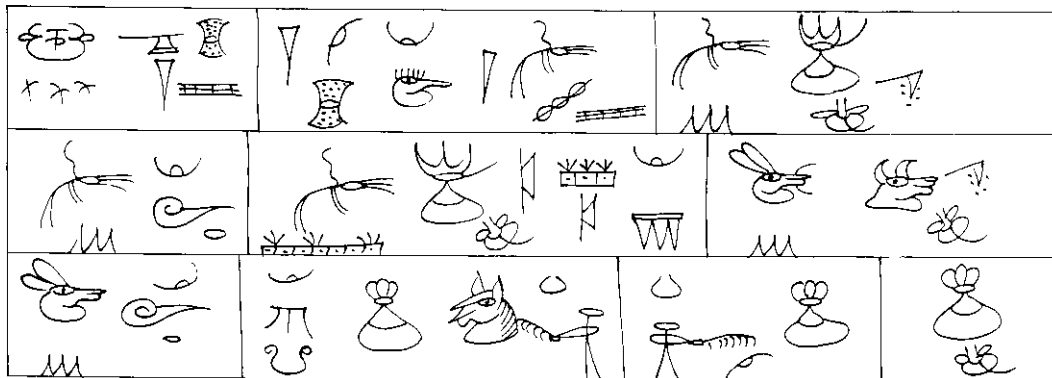

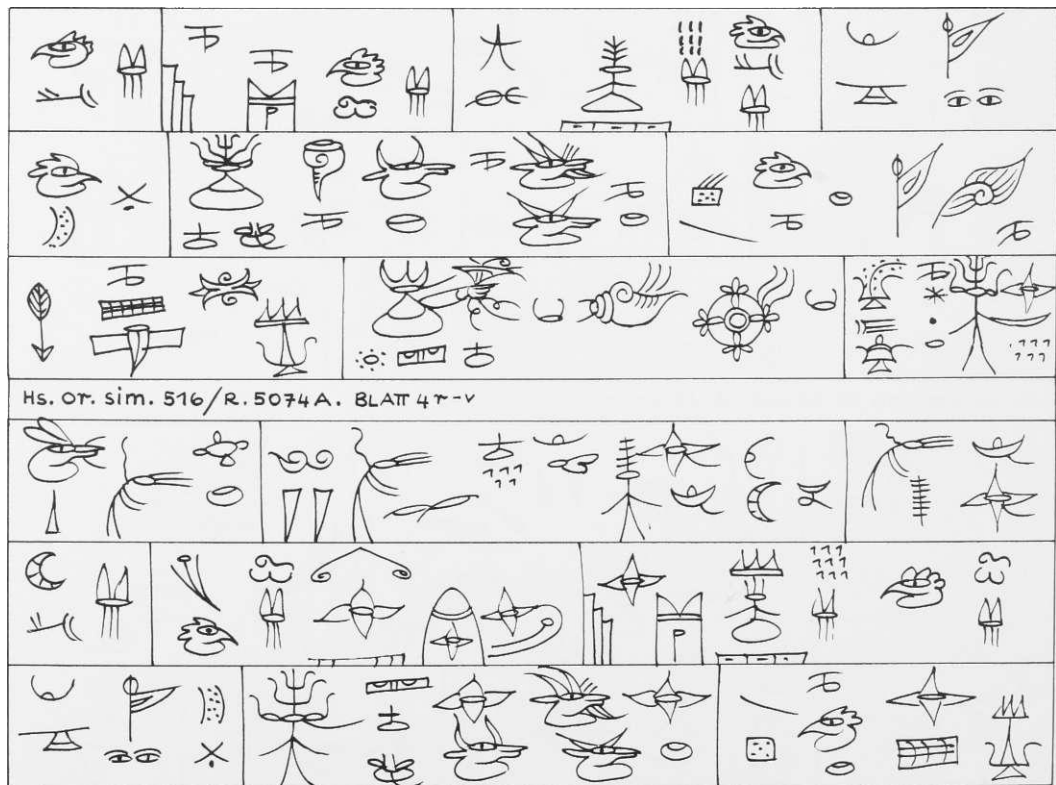
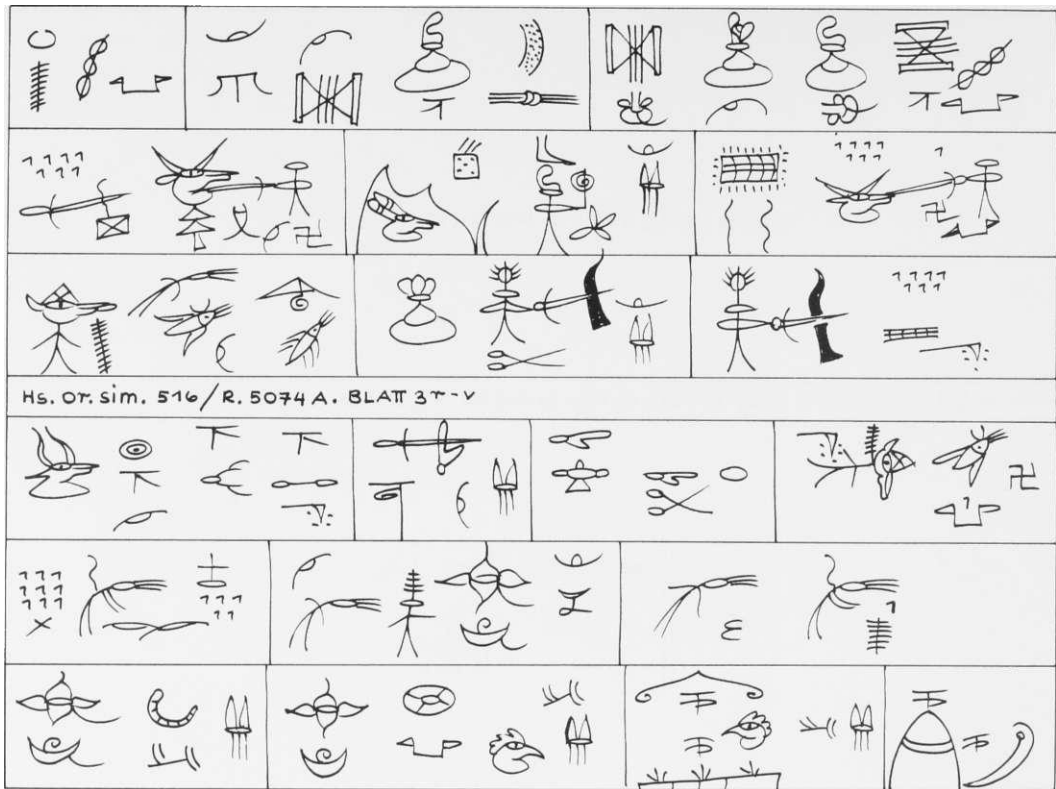

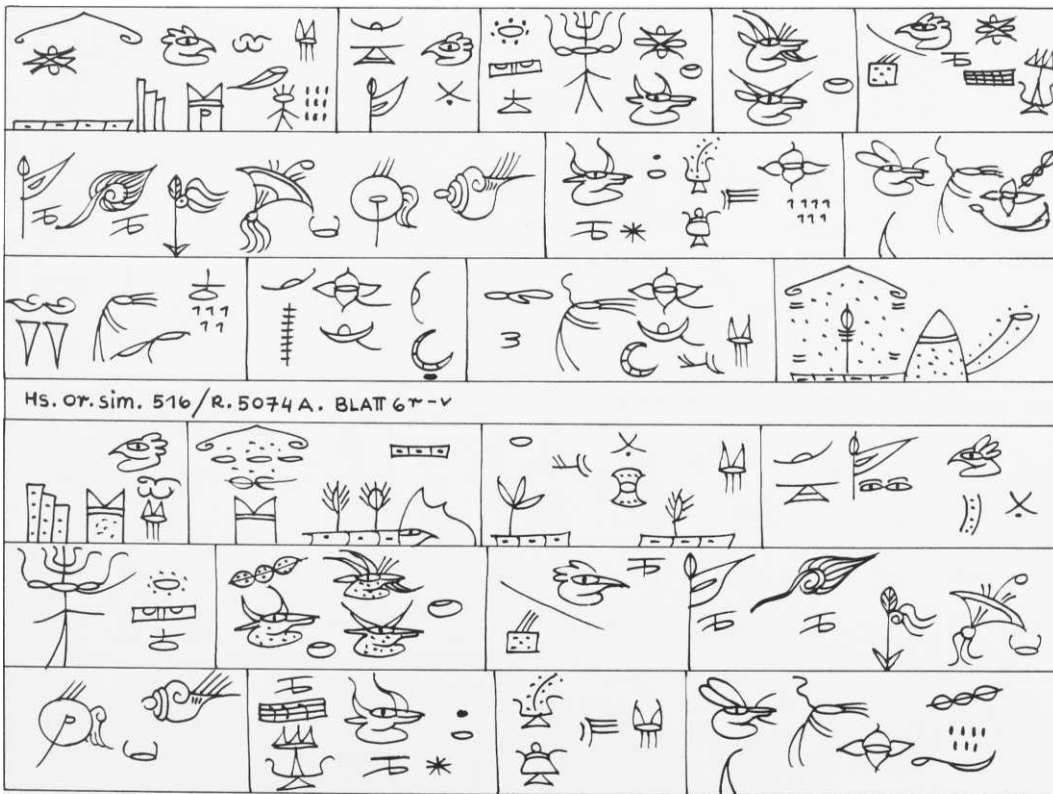
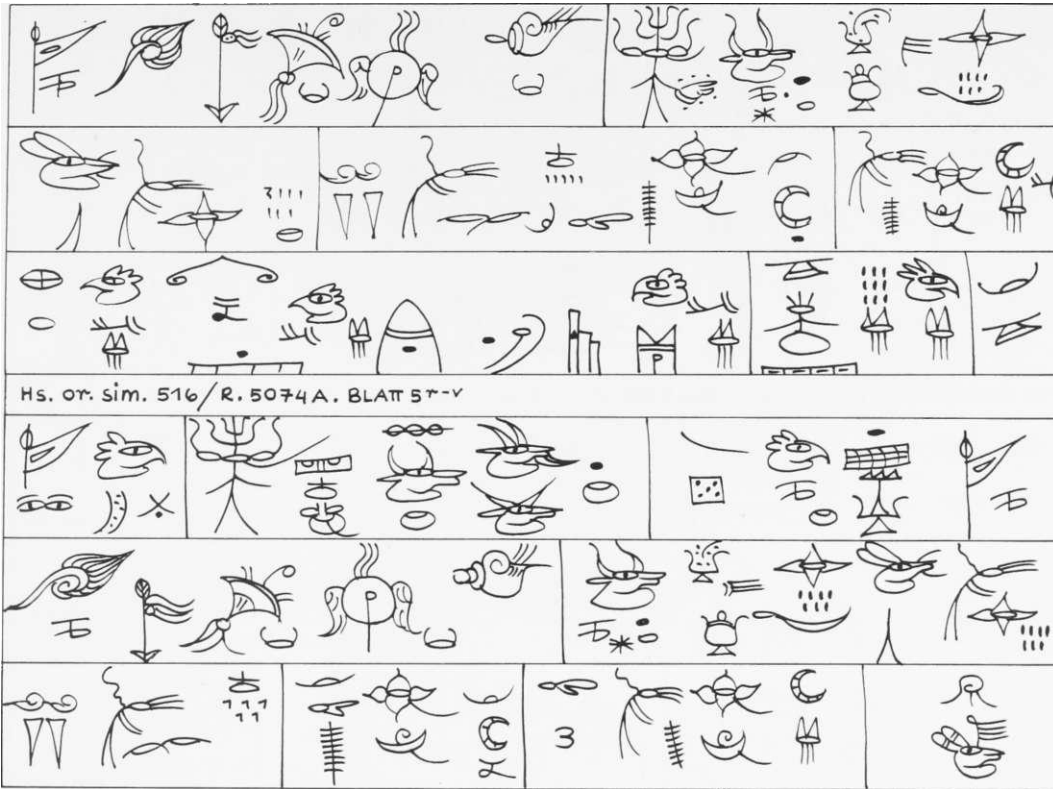

			1-1 -1-1 1-1 & ©
HS. Or. Sim. 5-1 (<i>offi.</i> 50^4 A. BLATT ?r--v			
	< 3 ^ W 3		

	I S	C2>

HS. OY-, sirn. 51fe/R. 50T4 A. BLATT 5^V

OR.?qfNAuTireu FEHLT

XIU, 9%Z - Hs.or.sim. 540/R..5108. Har La-LLü. te'ö.TVu. k'vj ö-sher. BLATT 1'

^0=

111

I i i / * » *
111

H U

X

111
11



^

»li-



- 5

fe

7 *

^

3 ° v ° V Ä J



2=D 3

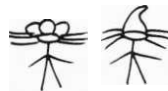

m i
111

Hs. Or. sim. St+o/ß. 510*. BLATT &r - v



S V

^4



% A

t u

Hs.or.sim. 540/B.. 510?. BLATT 3T--v	
	in

^ " Ä		S		
		0 ↕	r>^fe	A ^ Y
MS. or.sim. 540/«. 5-105. BLATT 4 ^ - ^				
			ill fe^ ' £ T "	' AAA
" AM ©		'AA/V\ fj: © * =		

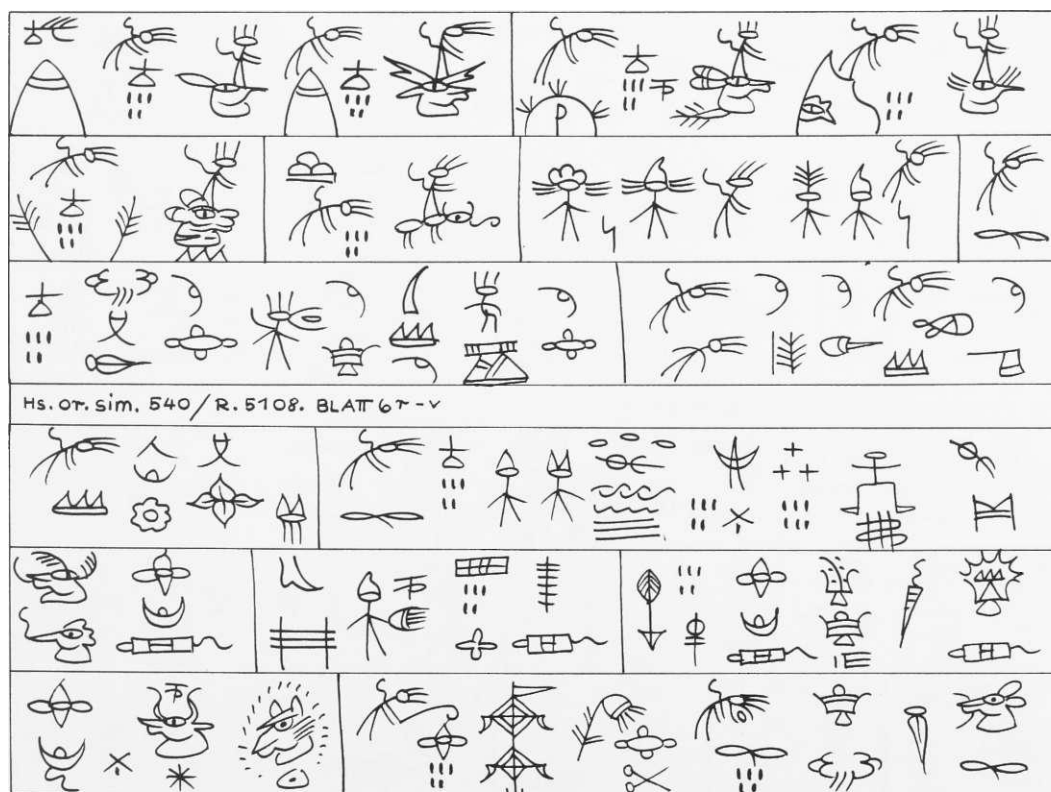
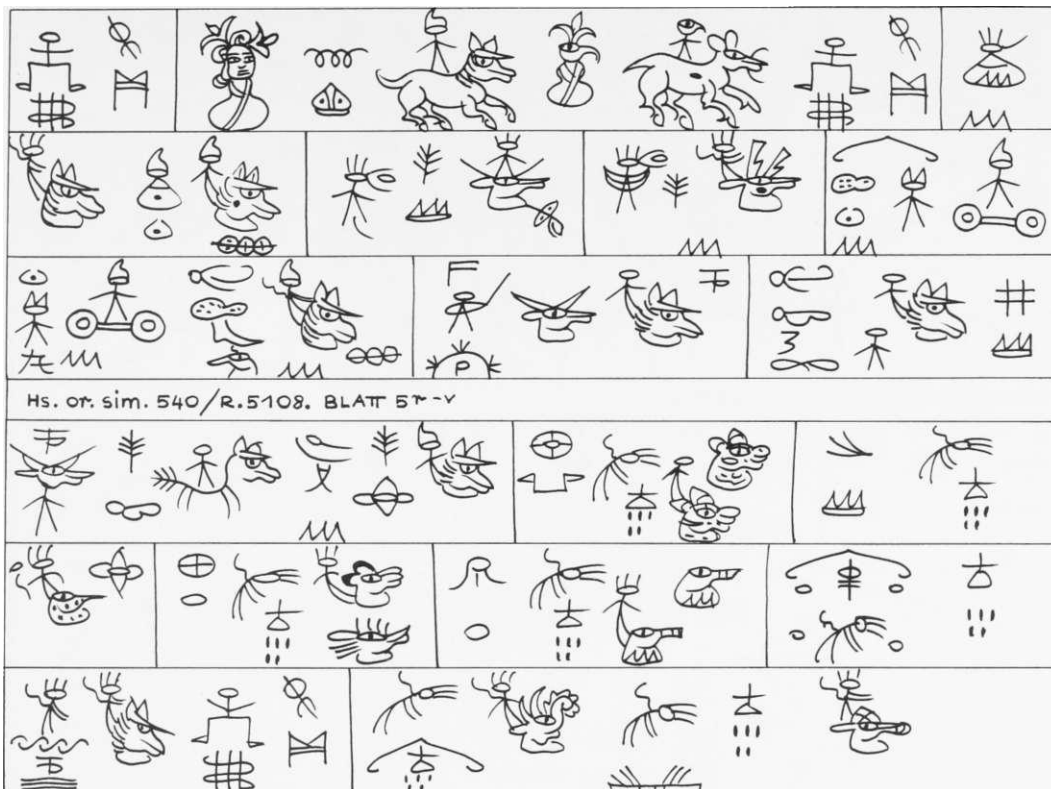

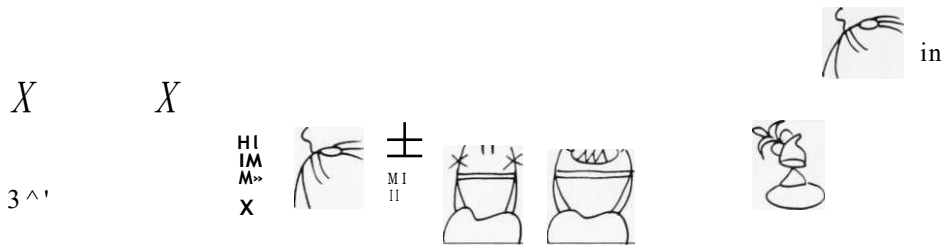

r 3

Hs. or. si*m. 540^XR. 510S. BLATT v

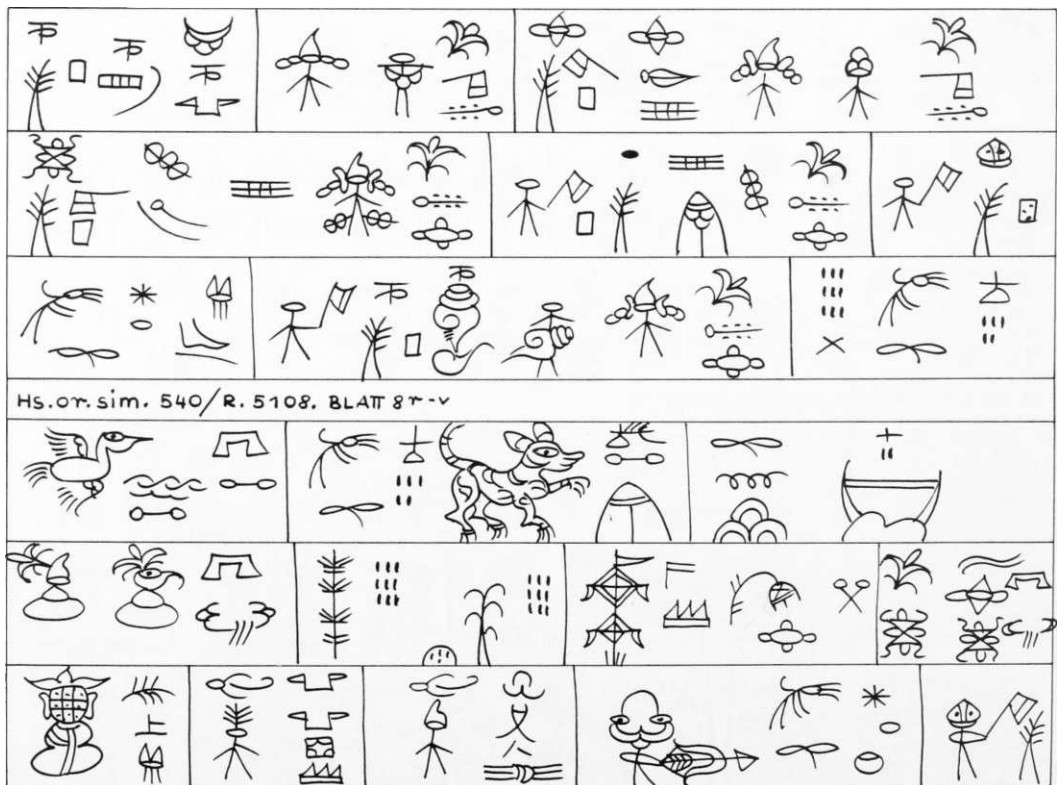
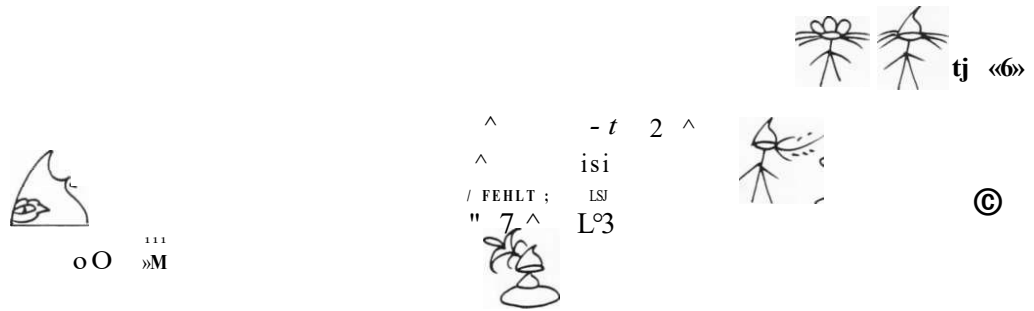

- S P ← ○ ○ ○ ○ ©			
^ R ^ A H		r / n fl ^ ^	

HS. oir. si"m. 540 /R. 510*. 8LATT 9^ - v

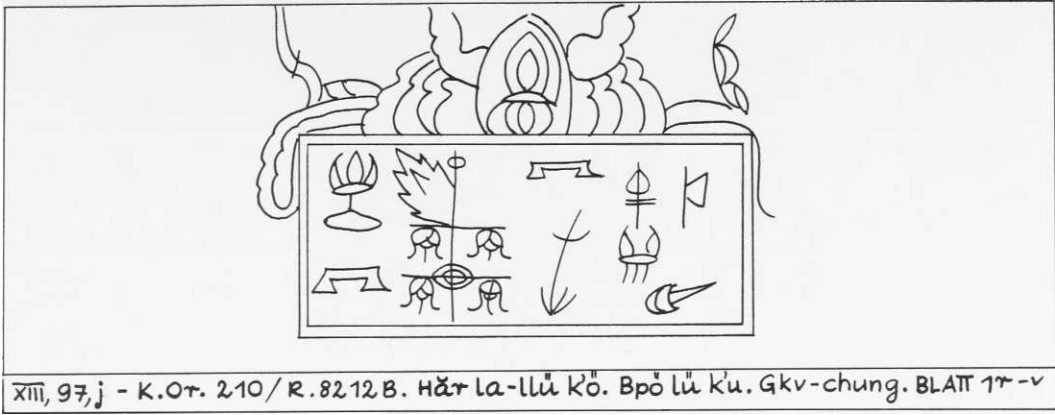

XIII, 97, j - K.Or. 210/R. 8212 B. Härt la-llü Kö. Bpö lü kü. Gkv-chung. BLATT 17-v

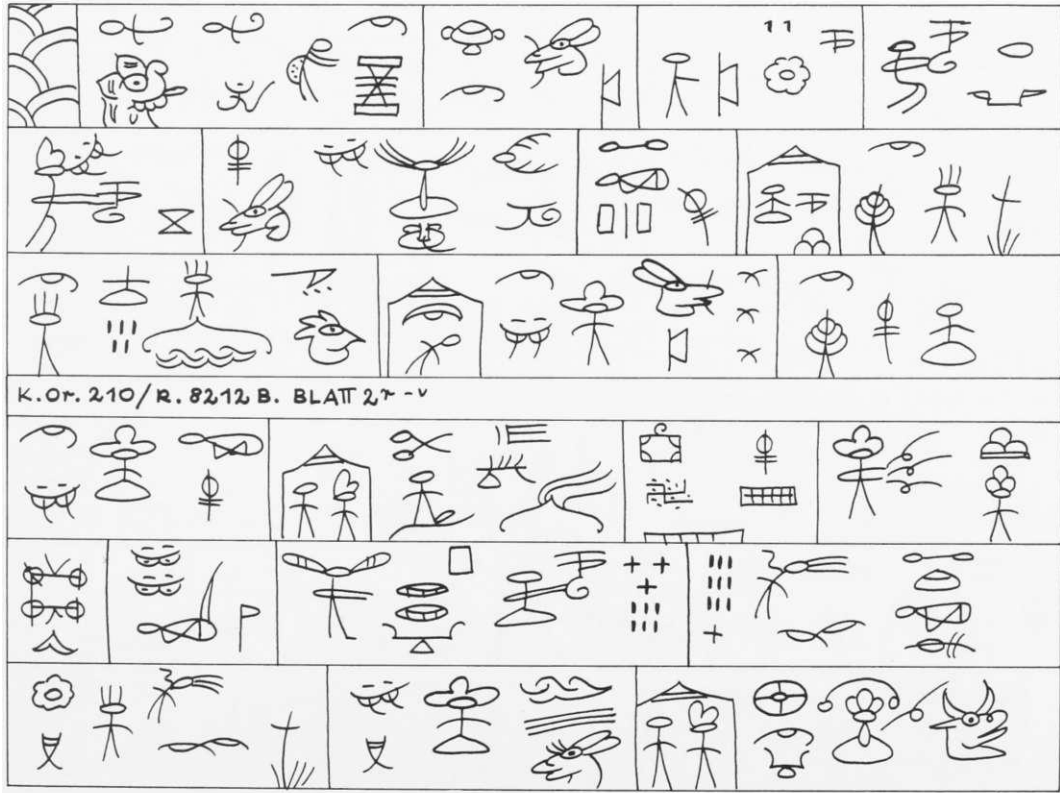

K.Or. 210/R. 8212 B. BLATT 27-v

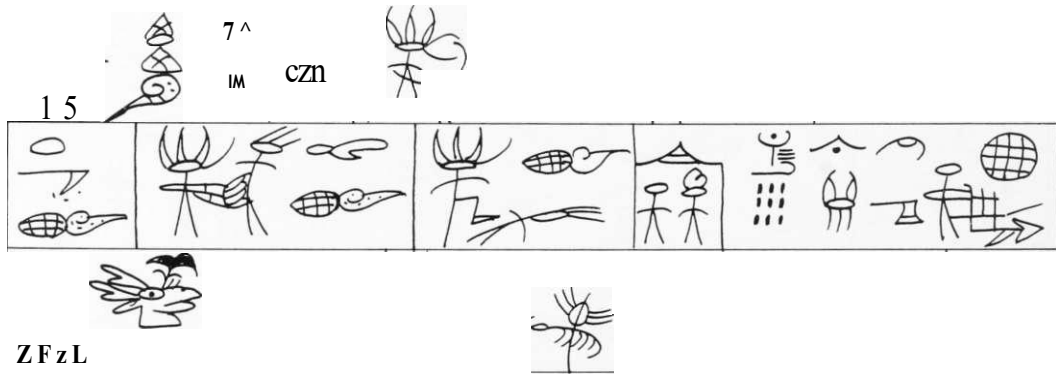
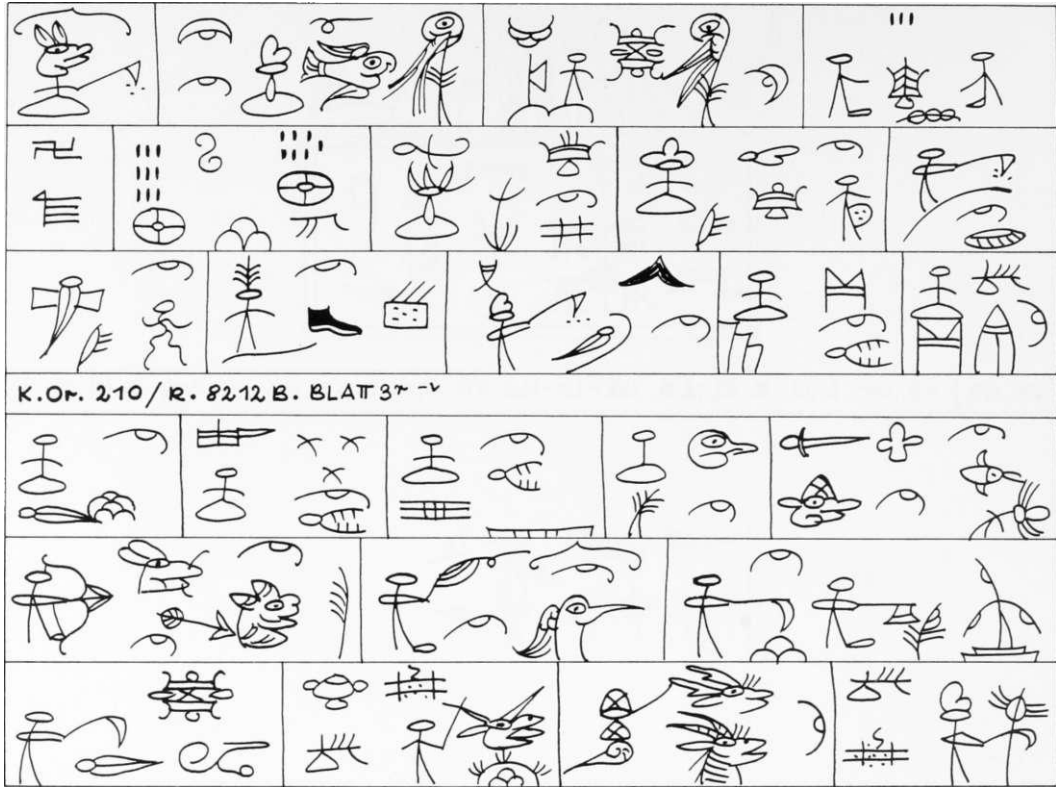

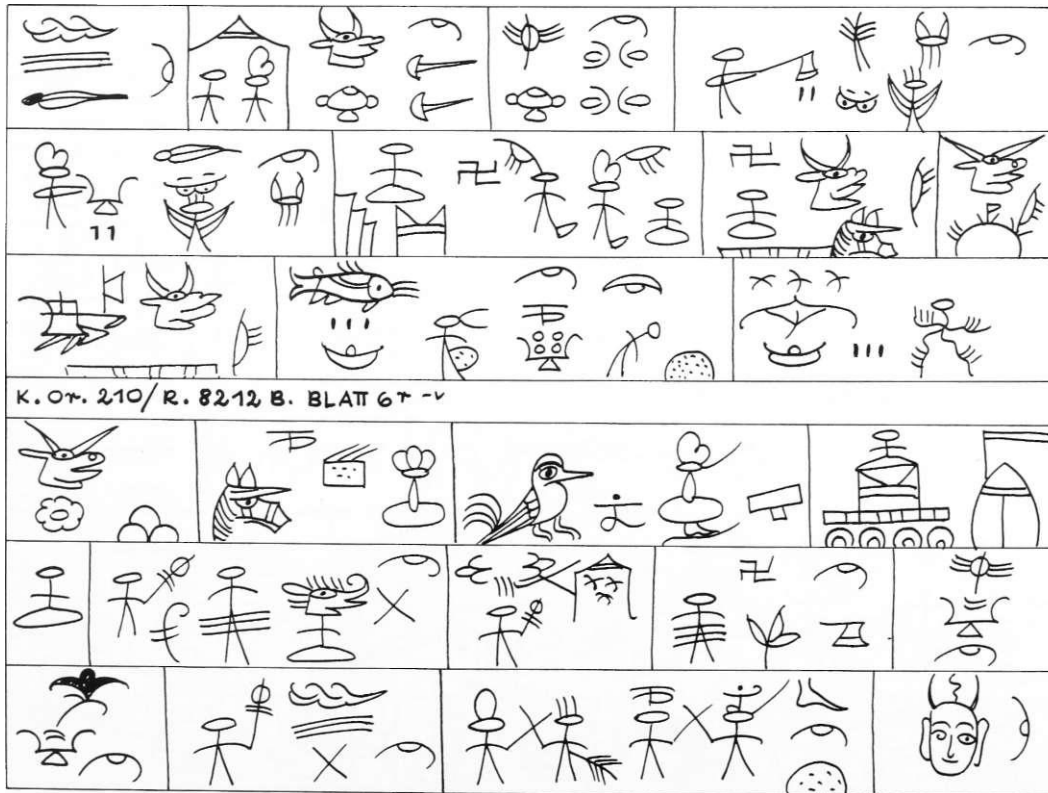
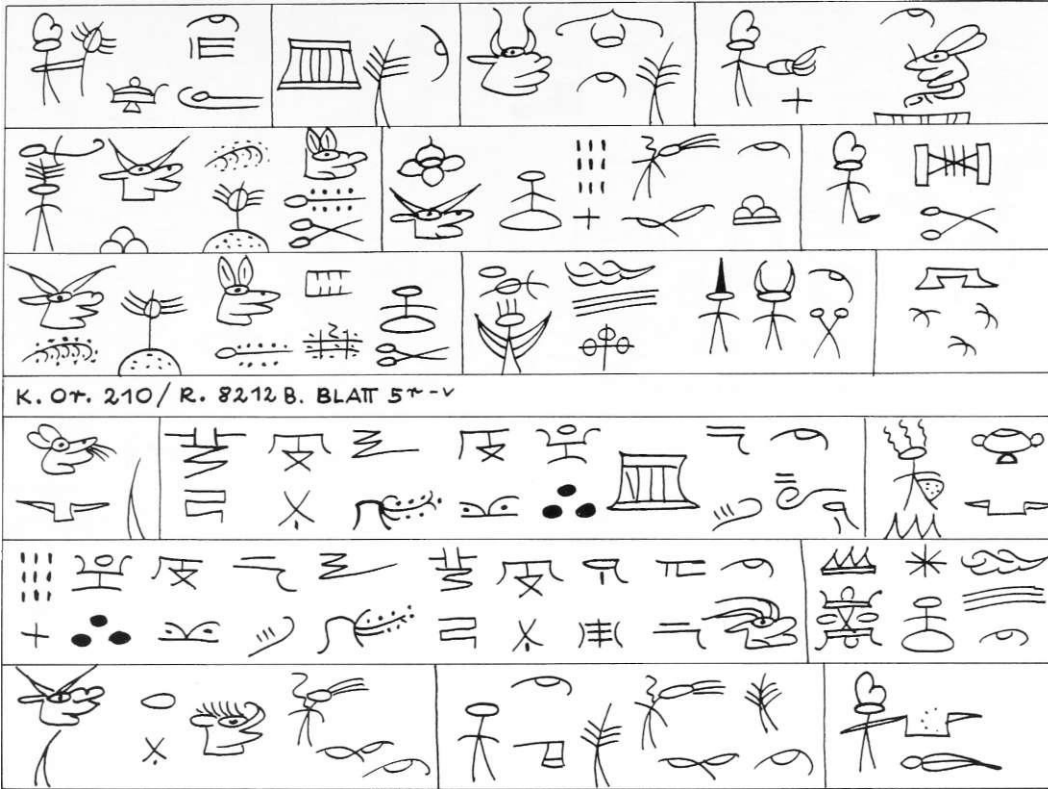

		Iba*.	
K.Or. Z10/R. ST/IZB- BLATT 9-			
	= ^ P	^ w l f i	
- \ ^	7 f # c ^		
	gl ^ ^	irf Bl > ^	

		n n r f f i	1
	% s i	t	
		+ u	IM IM 111 - -
K.Of. Z10/«. BLATT 8 ^ ^			
		ΛΛΛΛΛΛΛΛ	£>>

K.Of. 2/10/R. 82,12, B. BLATT

GS -- AAA t		
Iflis	2 b ^ M I rs/1 11	^ ° f i = ° S ° x °
II ^ II v 4- 1	1 7 ^ ff f	

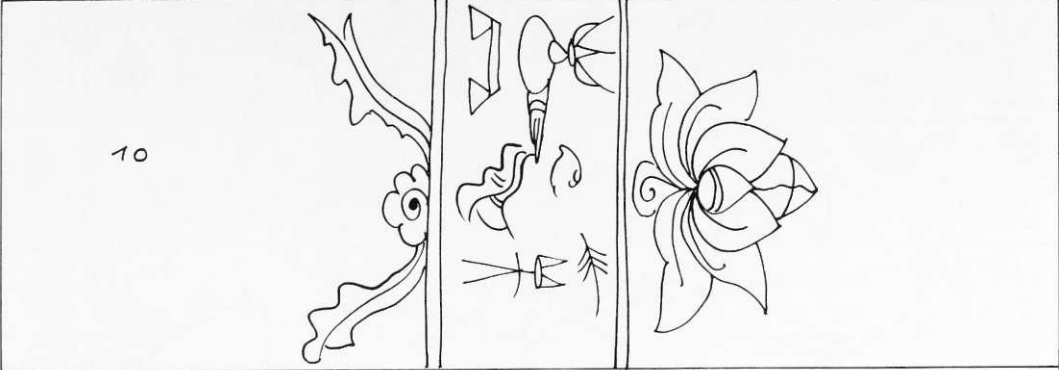

10

XIII, 97, j - Hs. or. sim. 554/R. 714. Hãr la-llü k'ö. Bpö lü k'u. Gkv-chung. BLATT 1 r-v

R.OCI4:

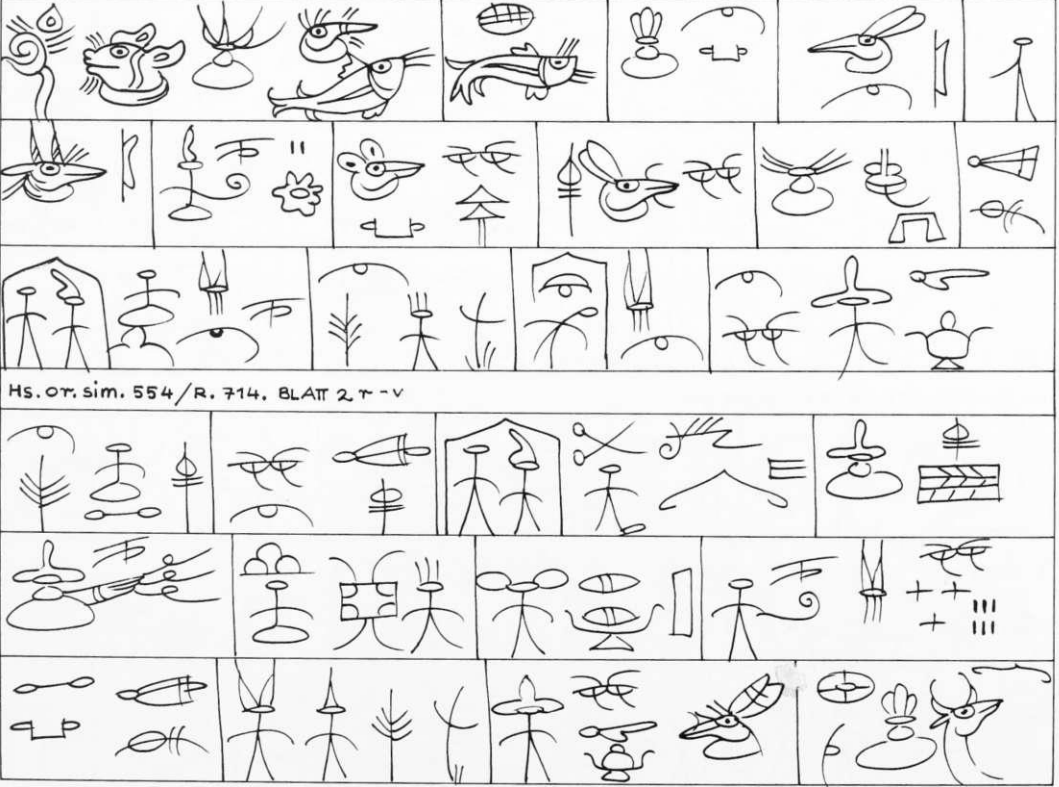

Hs. or. sim. 554/R. 714. BLATT 2 r-v

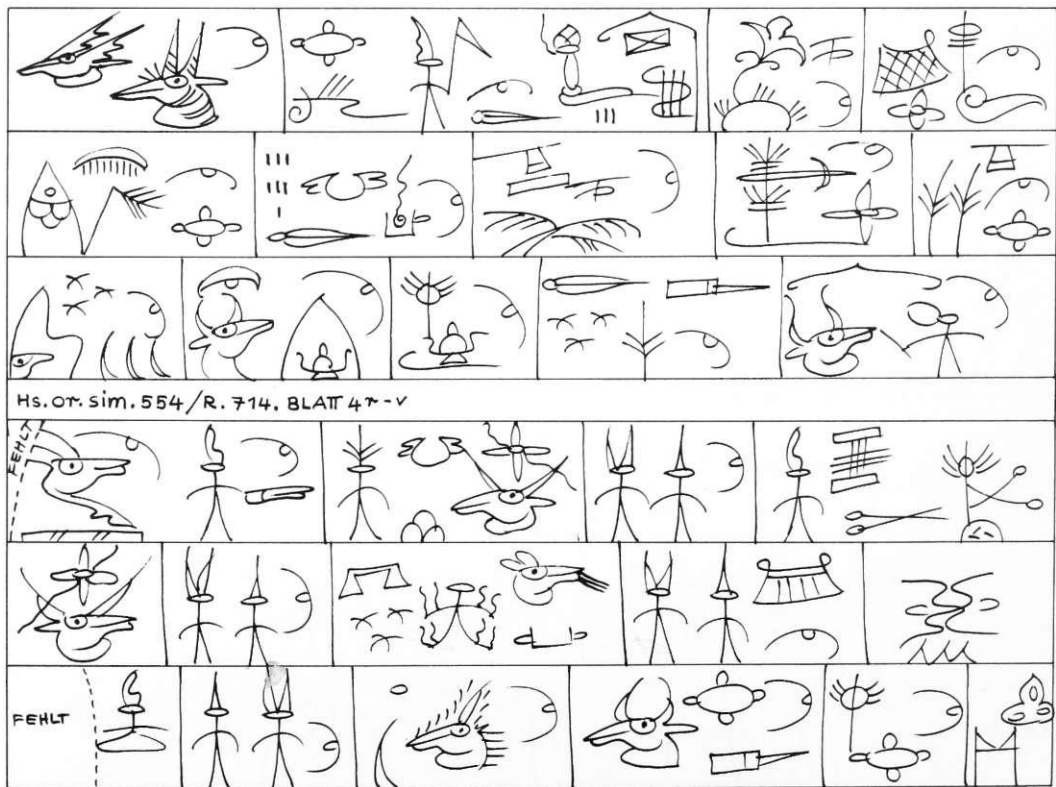
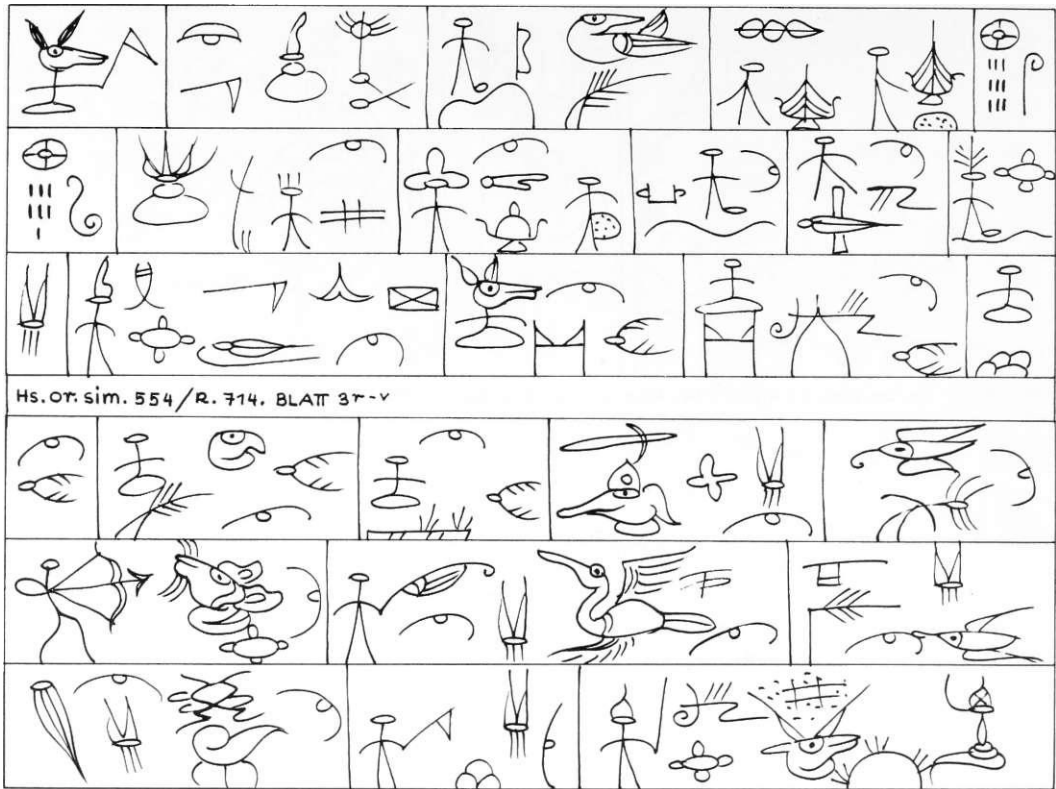

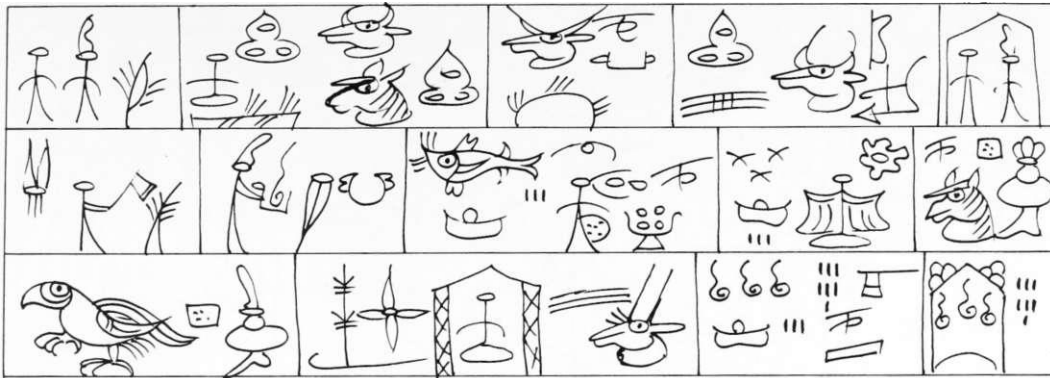

Hs. Or. sim. 554 / R. 714. BLAT 5^{r-v}

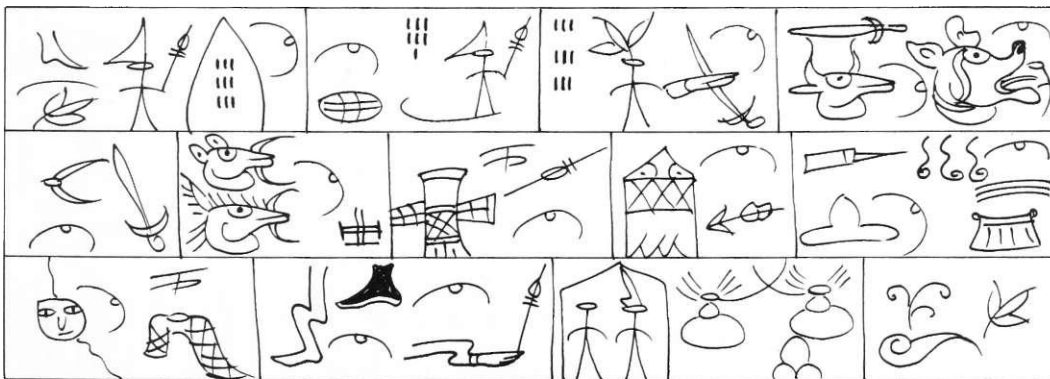
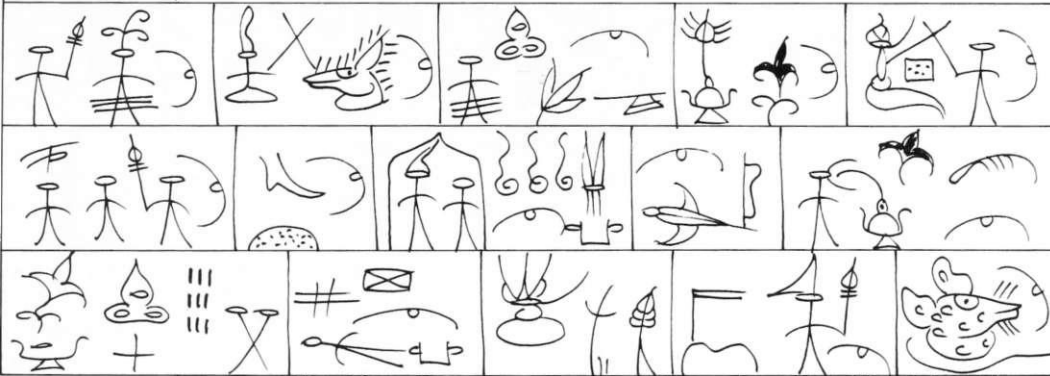

Hs. Or. sim. 554 / R. 714. BLAT 6^{r-v}

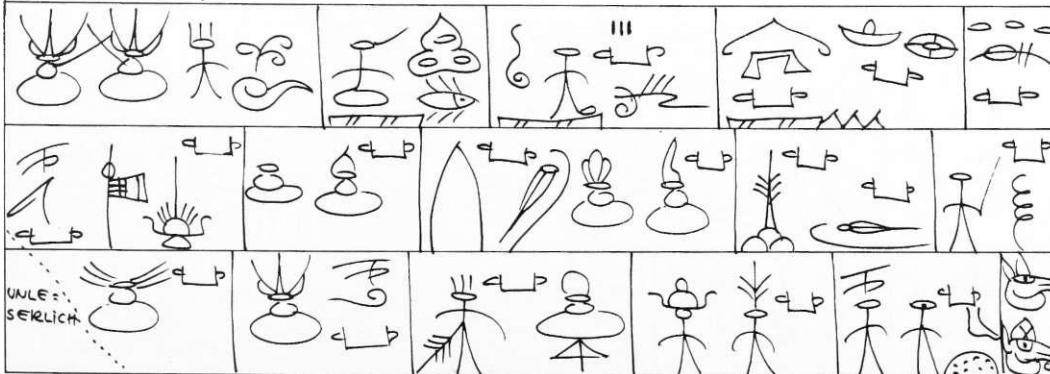

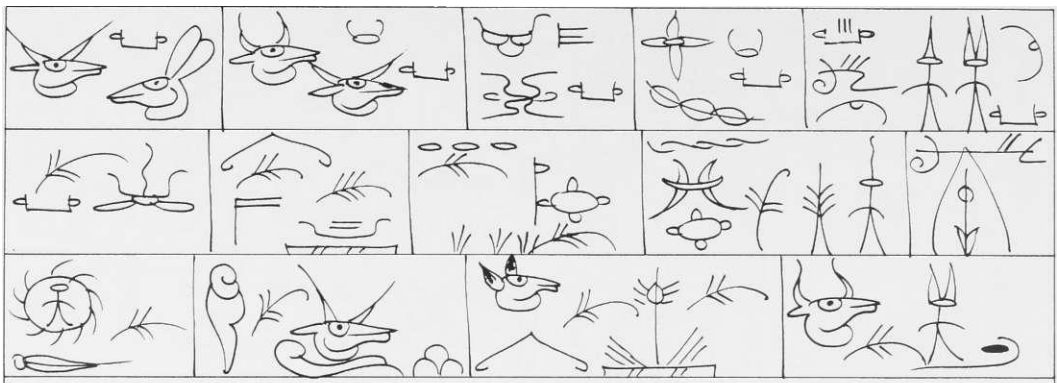

Hs. or. sim. 554/R. 714. BLATT 7^{r-v}

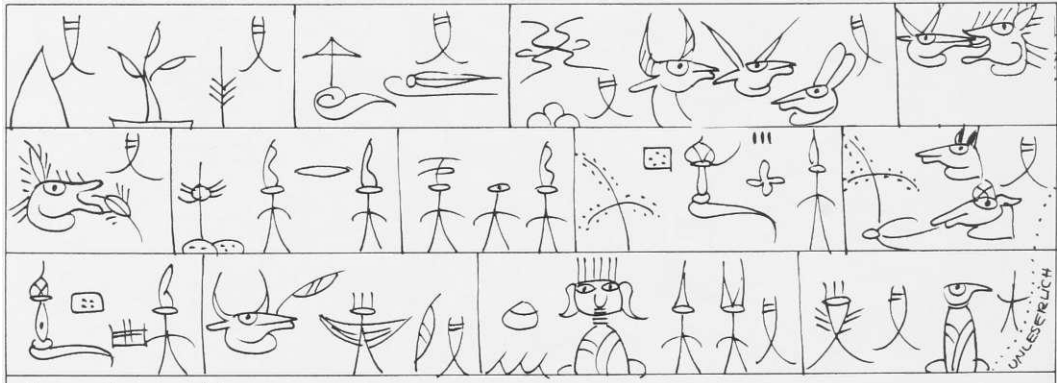
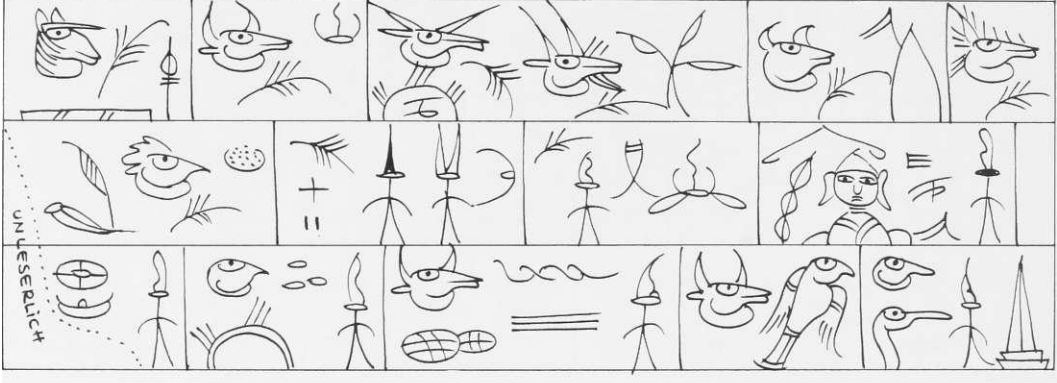

Hs. or. sim. 554/R. 714. BLATT 8^{r-v}

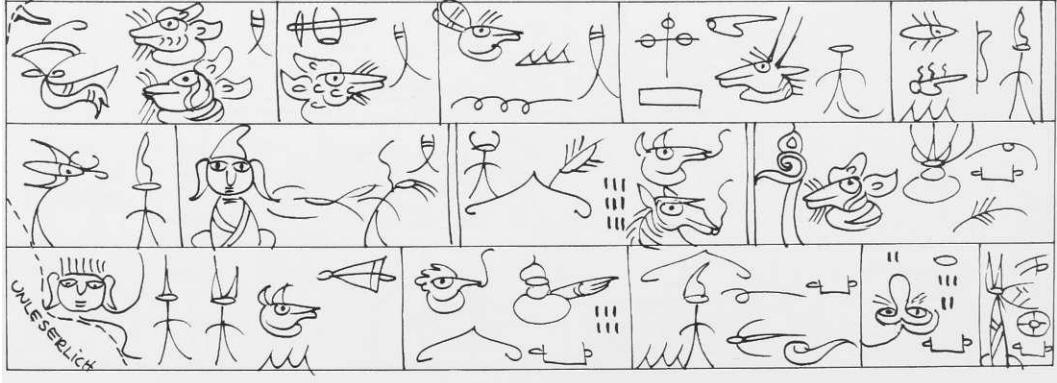

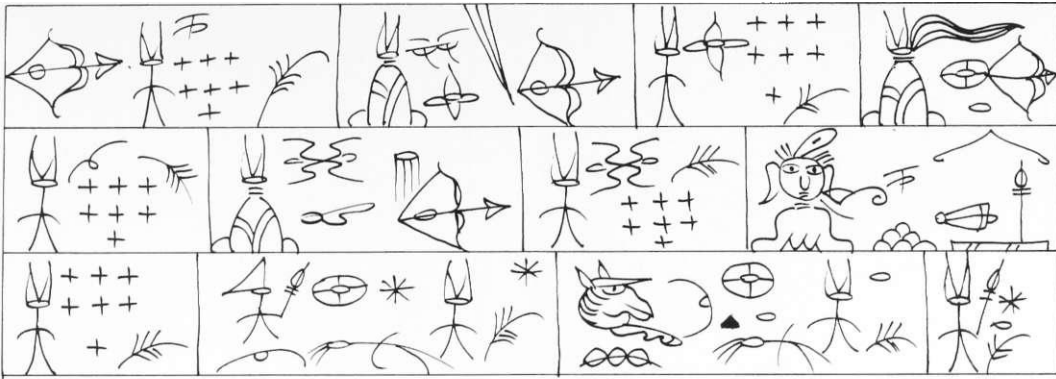

Hs. Or. sim. 554 / R. 714. BLATT 9r-v

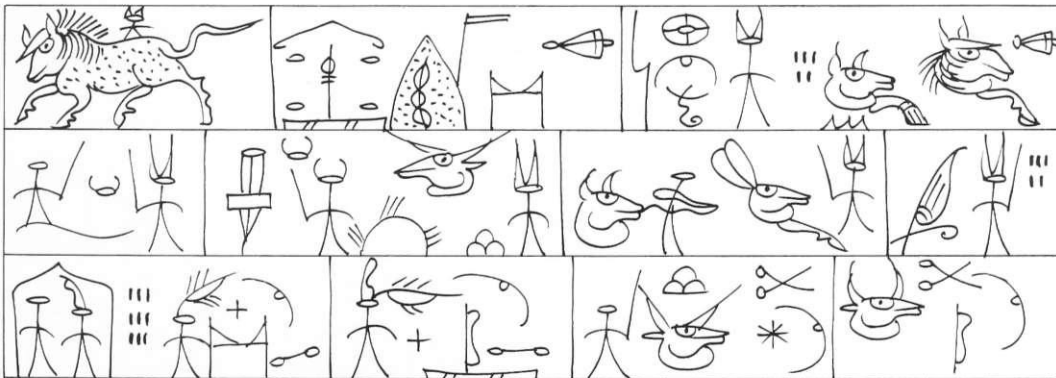
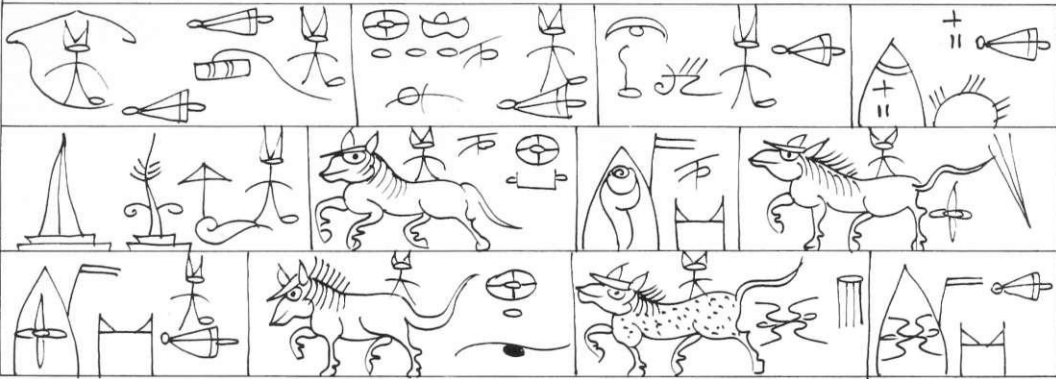

Hs. Or. sim. 554 / R. 714. BLATT 10r-v

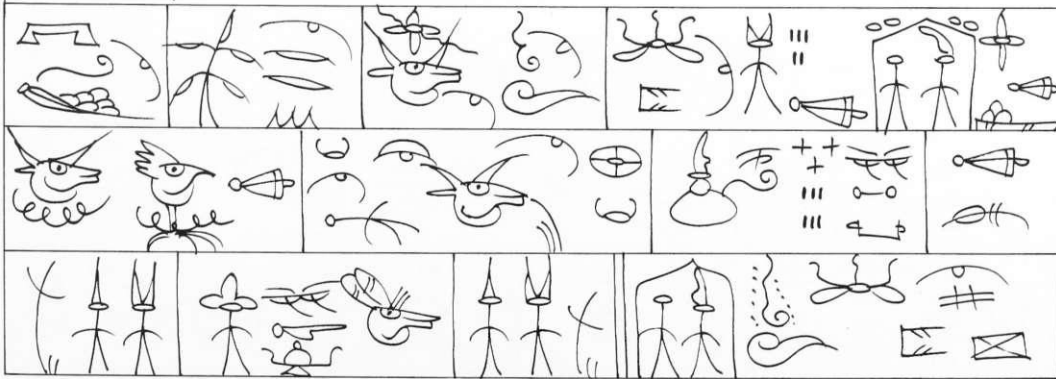

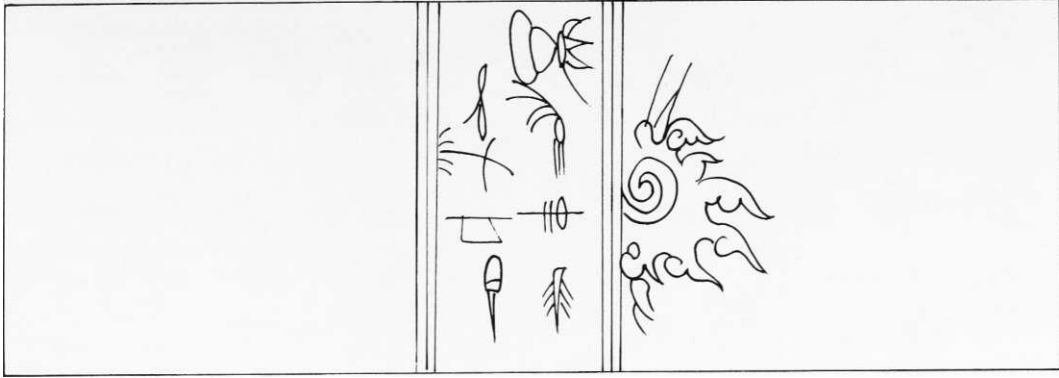

xm, 9 ^ k - Hs.or. sim. S 99/R. 1493. Hö/r LO-LIÜ. £ö. Bpö lü.fc'u..Mctn-chung. BLATT | * - "

R.OCIC: **A t ^**

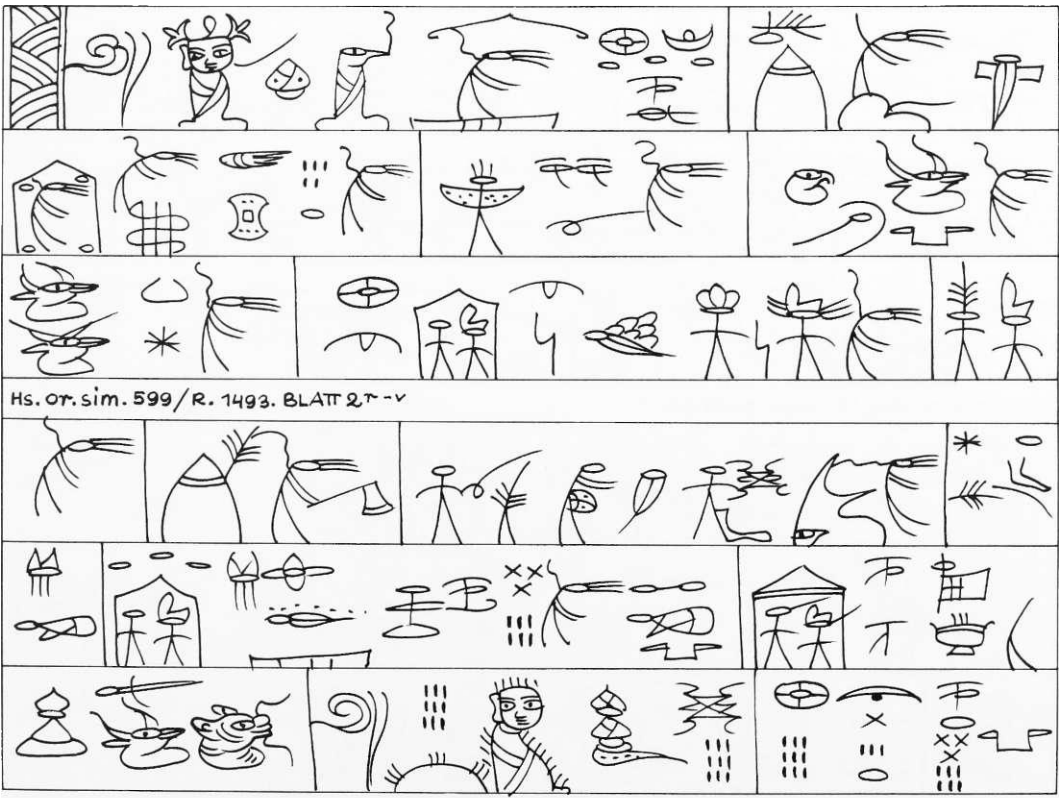

Hs. or. sim. 599/R. 1493. BLATT 2r-v

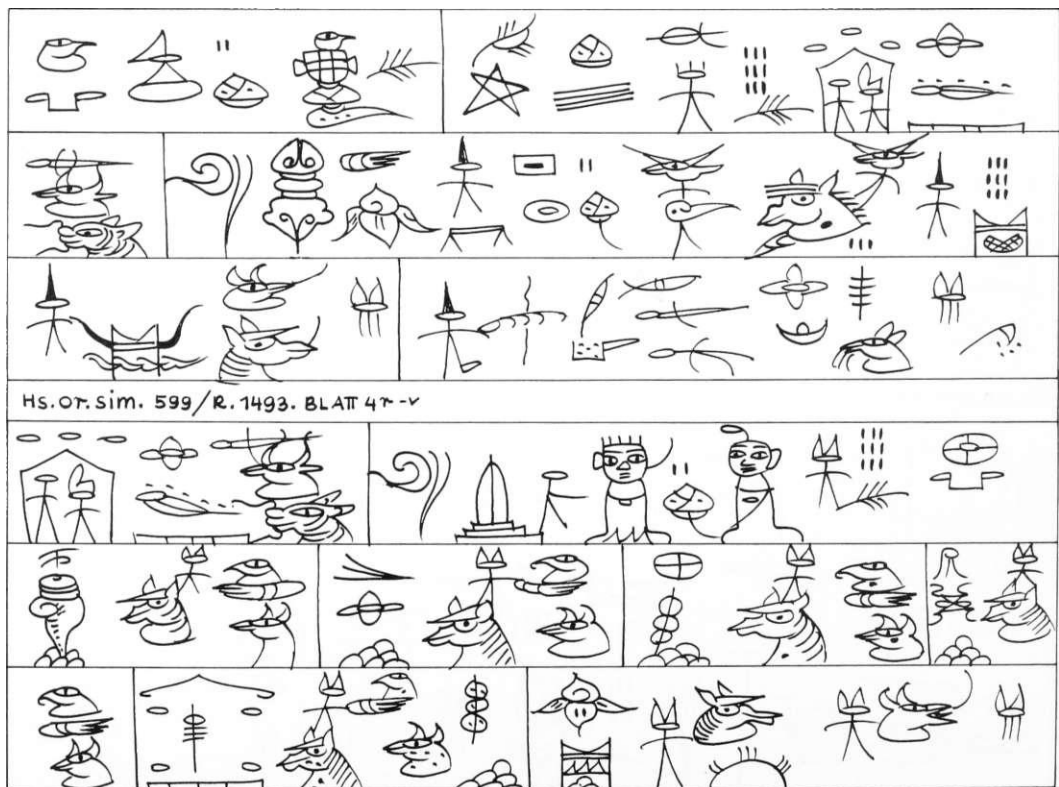
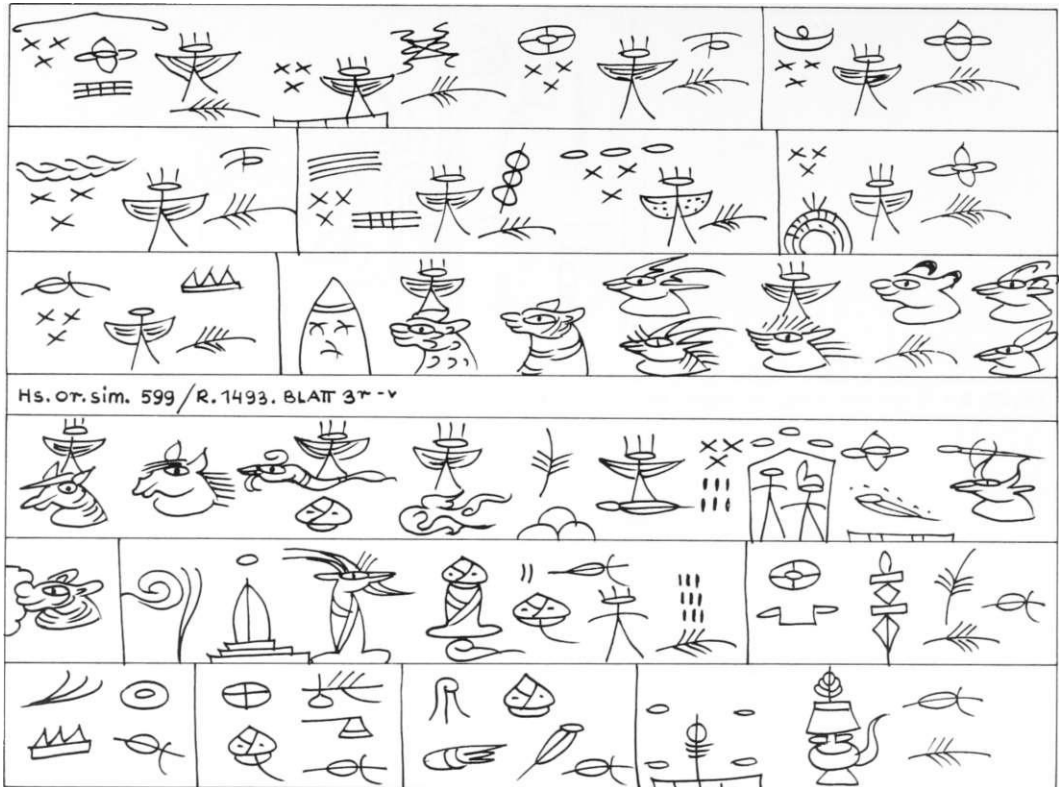

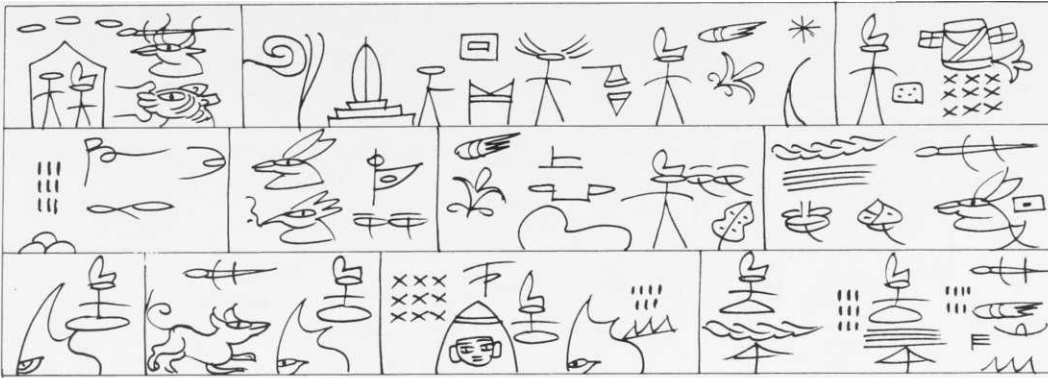

Hs. Or. sim. 599/R. 1493. BLATT 57-V

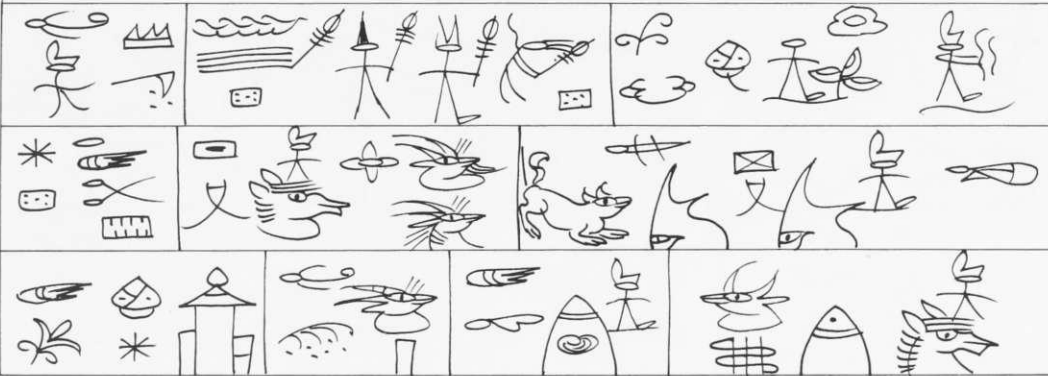

Hs. Or. sim. 599/R. 1493. BLATT 63-V

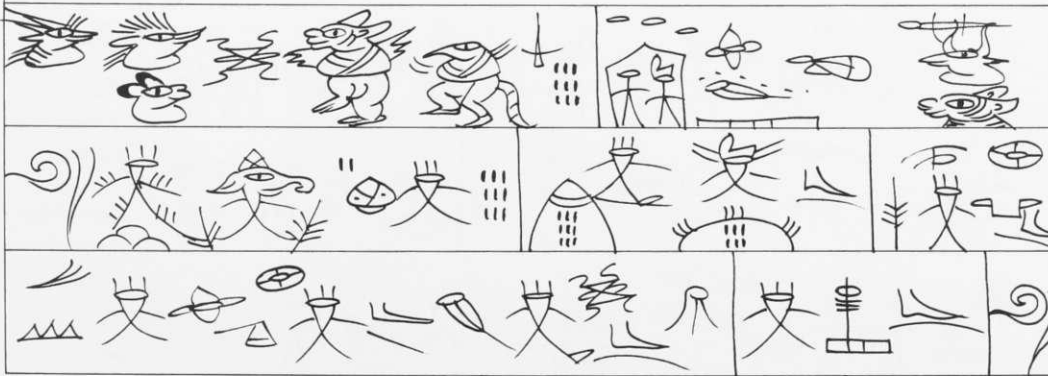

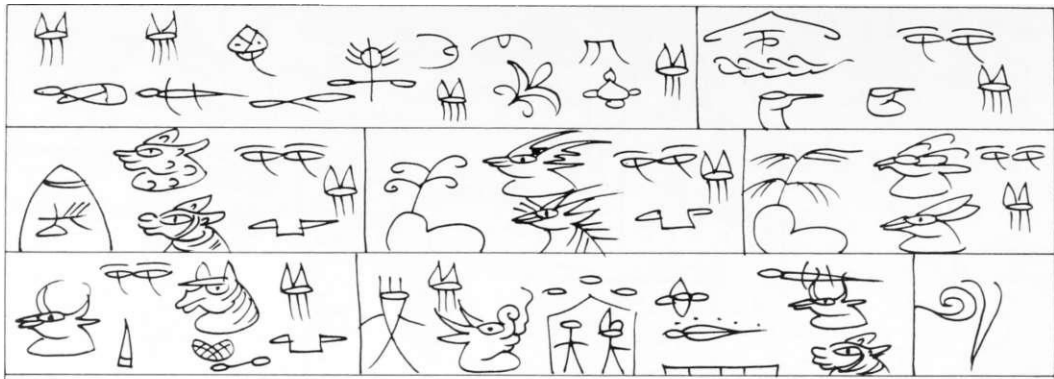

Hs. or. sim. 599 / R. 1493. BLATT 77-V

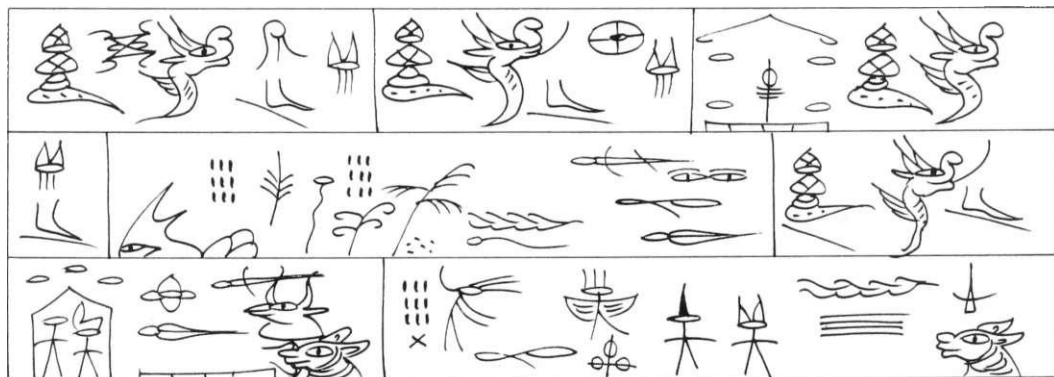
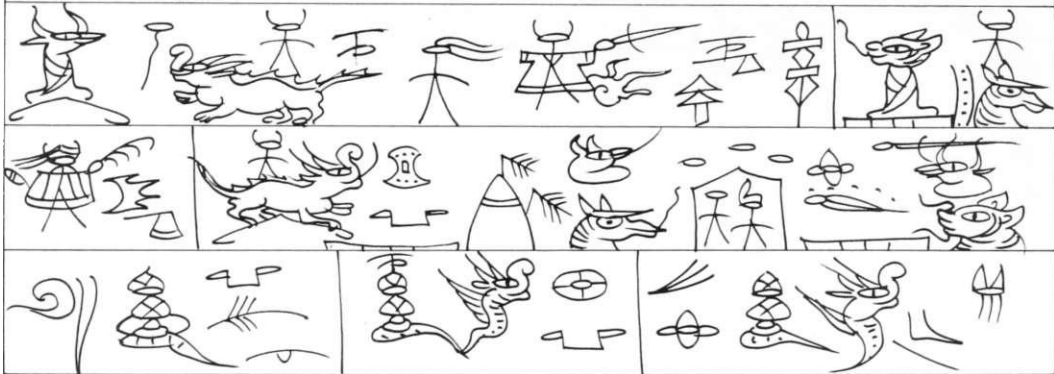

Hs. or. sim. 599 / R. 1493. BLATT 87-V

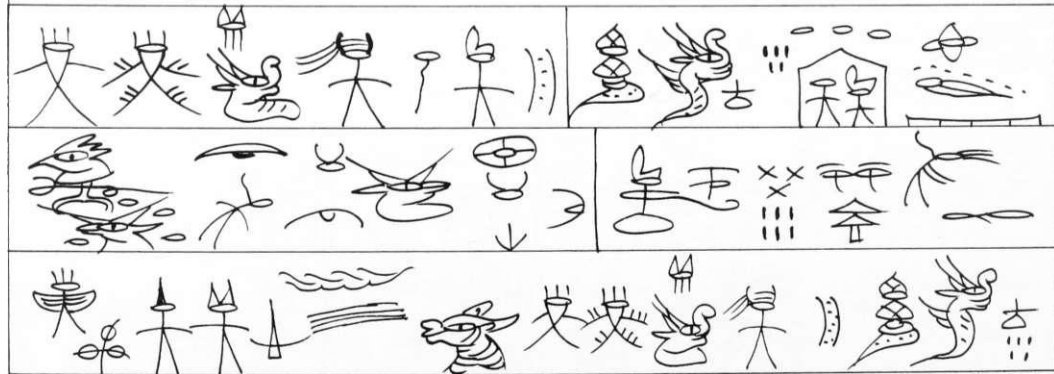

X X
III
MI

Hs.or.sim. 599/B. 1^93. SLAT 9 ^

10

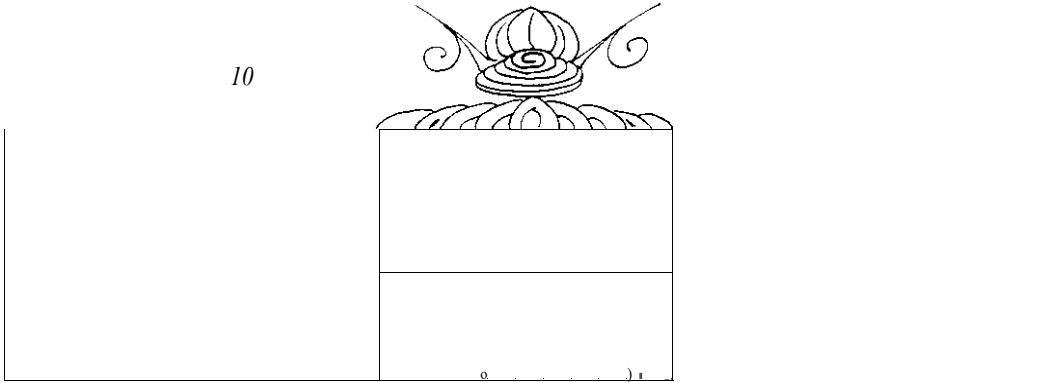

man-chung. BLATT 1'

ROCK'

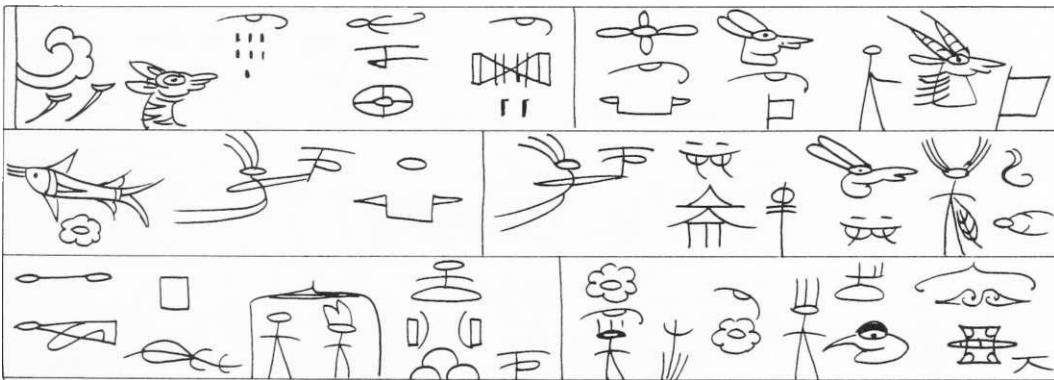

K. Or. 2/2.0/ β.,8%8 B. BLATT fer-"

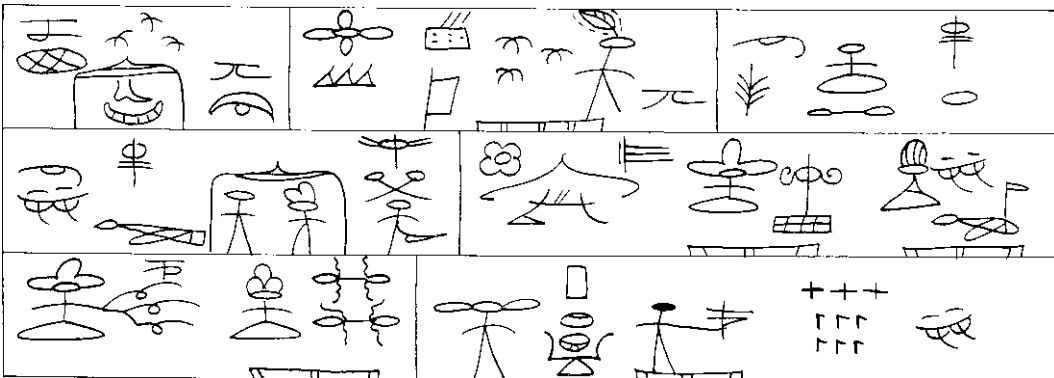

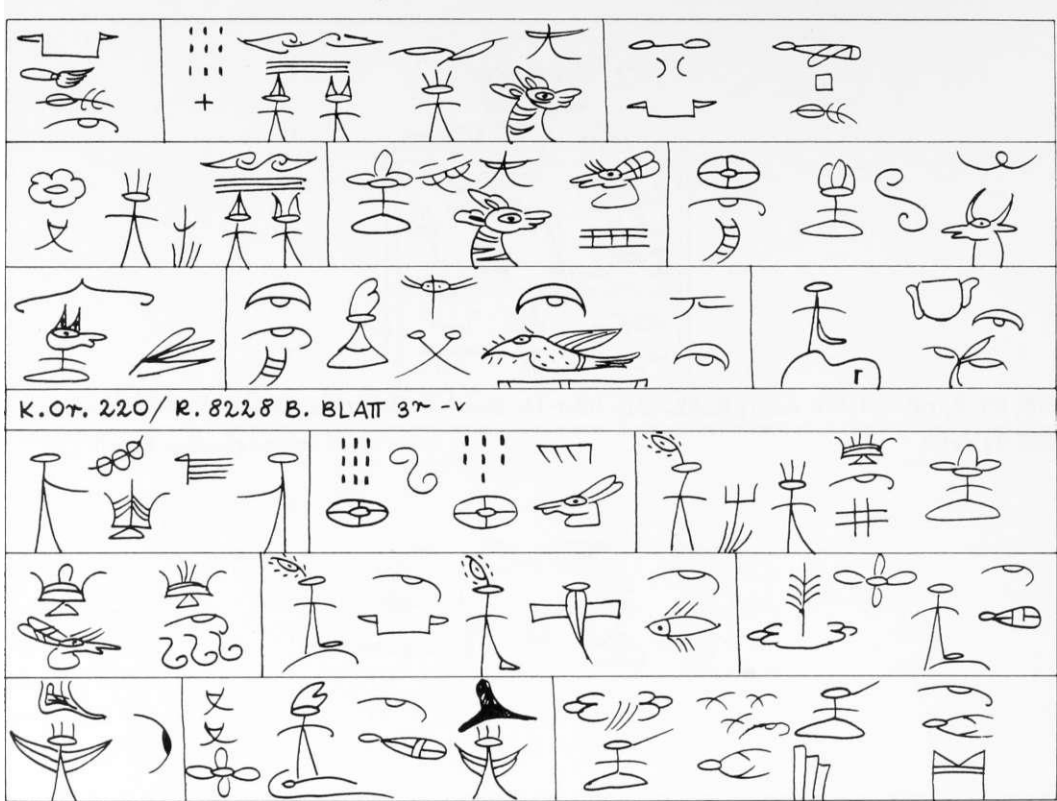

	B. BLATT ^ ~	
1X1	2"	
 $i^{\wedge} - , "55j_0 \wedge \sim \rightarrow$	^	\

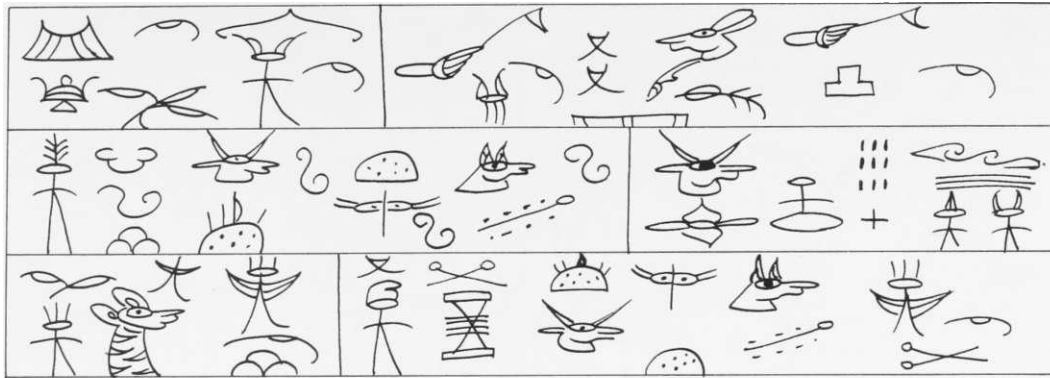

K. OT. 220 / R. 8228 B. BLATT 5^{r-v}

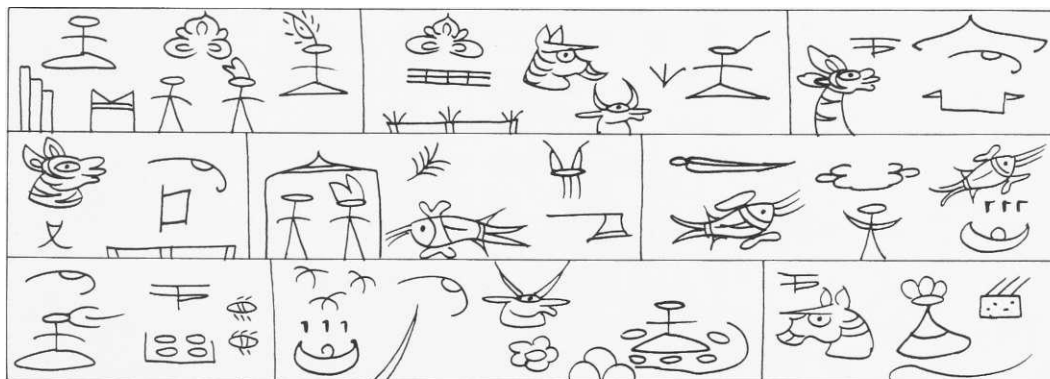
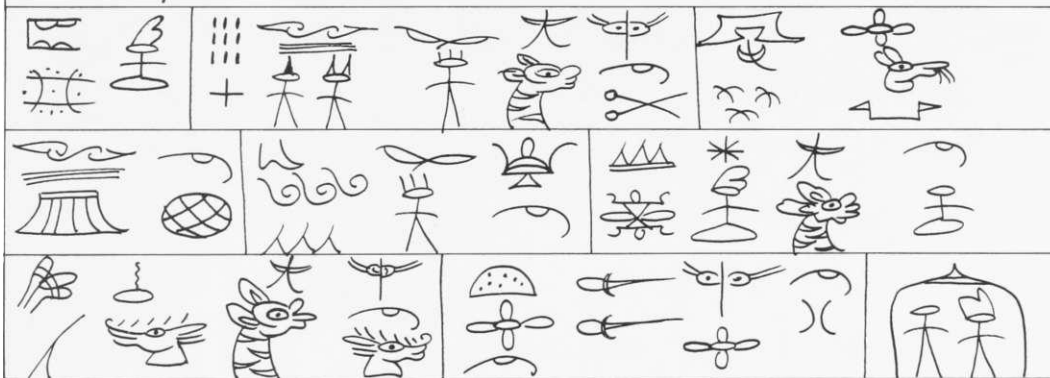

K. OT. 220 / R. 8228 B. BLATT 6^{r-v}

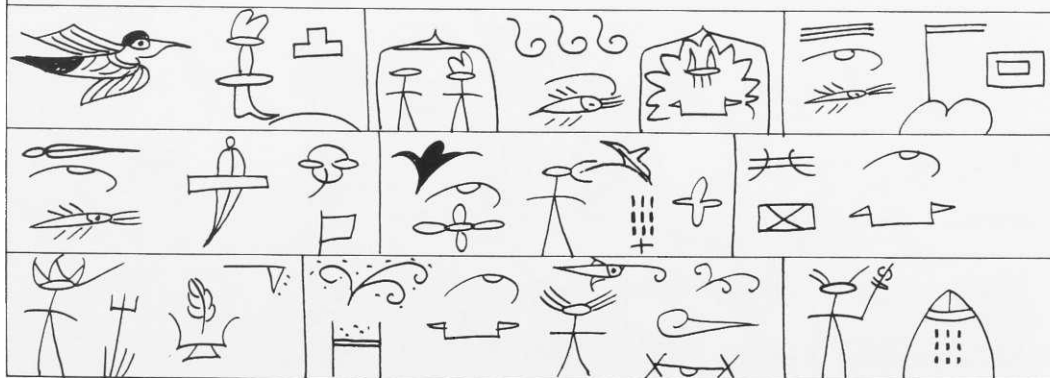

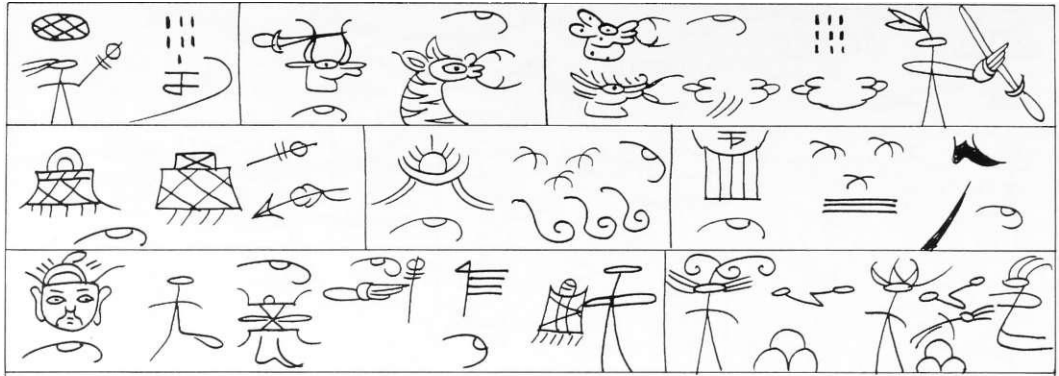

K. Or. 220 / R. 8228 B. BLATT 7r-v

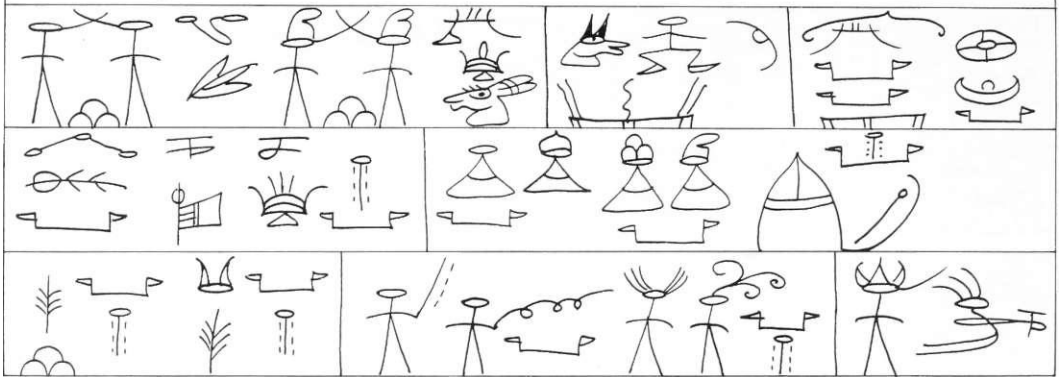

K. Or. 220 / R. 8228 B. BLATT 8r-v

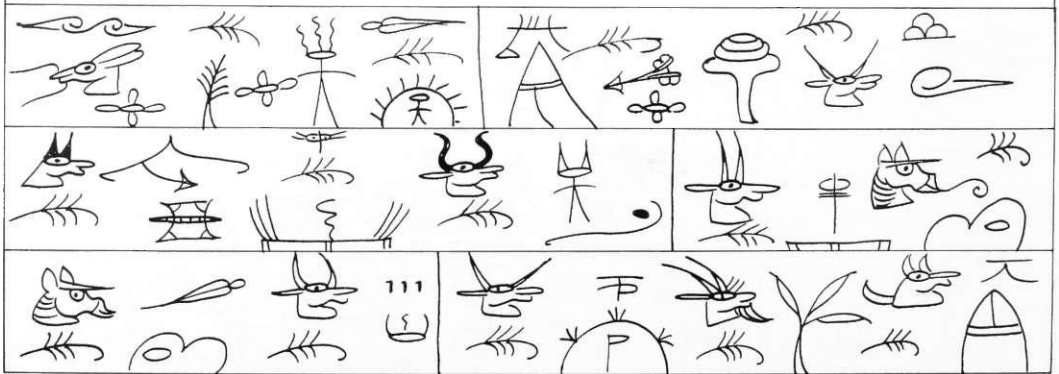

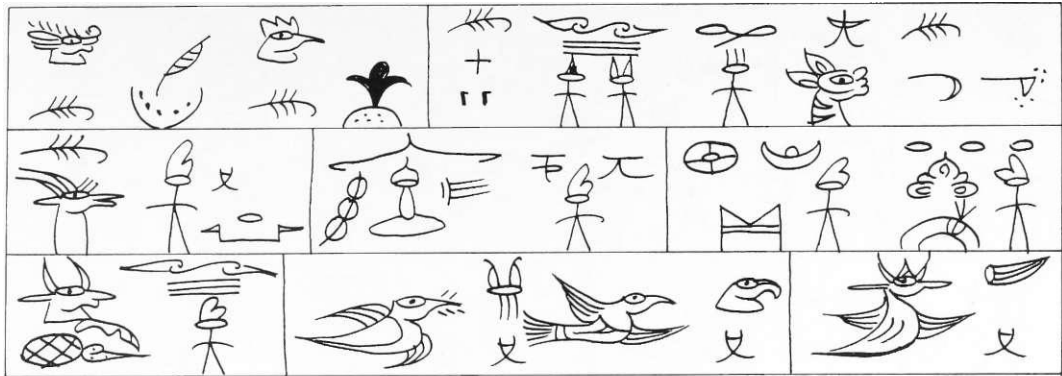

K. O. r. 220 / R. 8228 B. BLATT 9 r - v

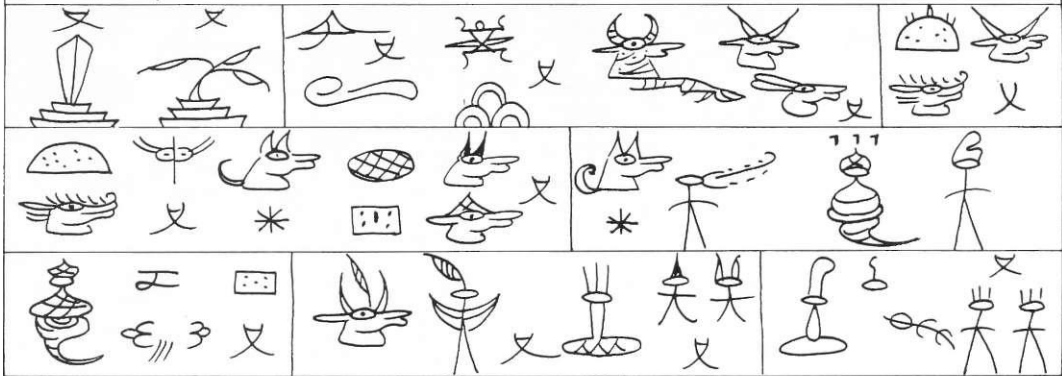

K. O. r. 220 / R. 8228 B. BLATT 10 r - v

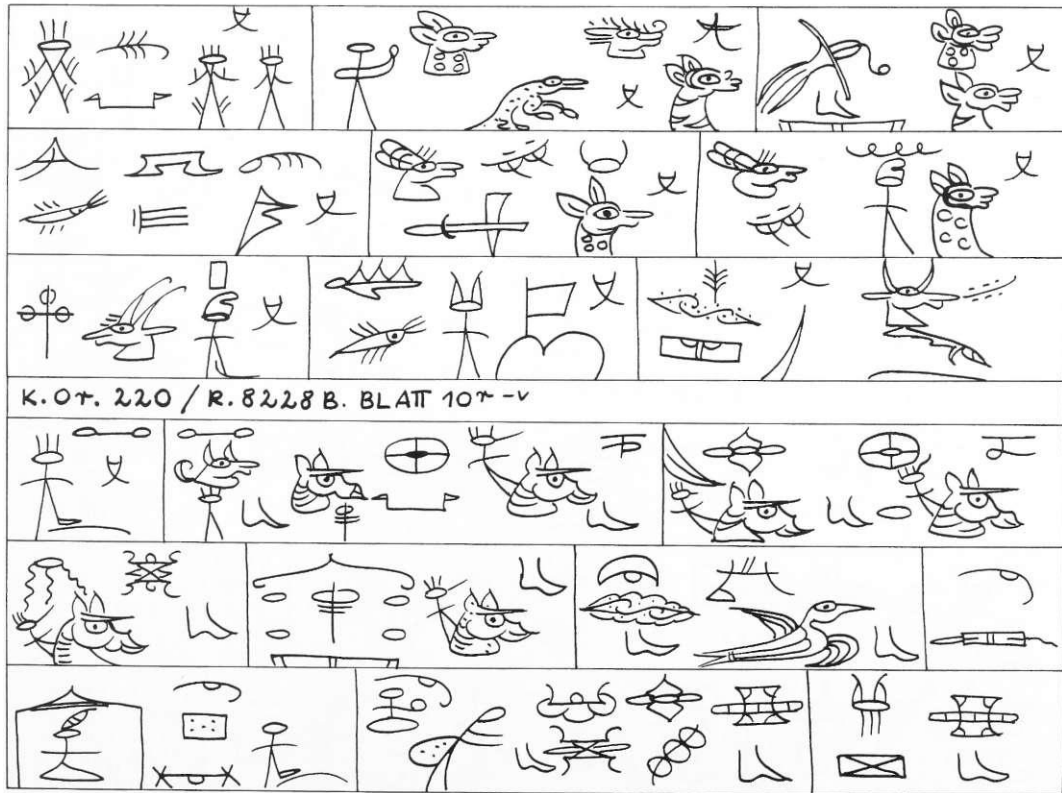

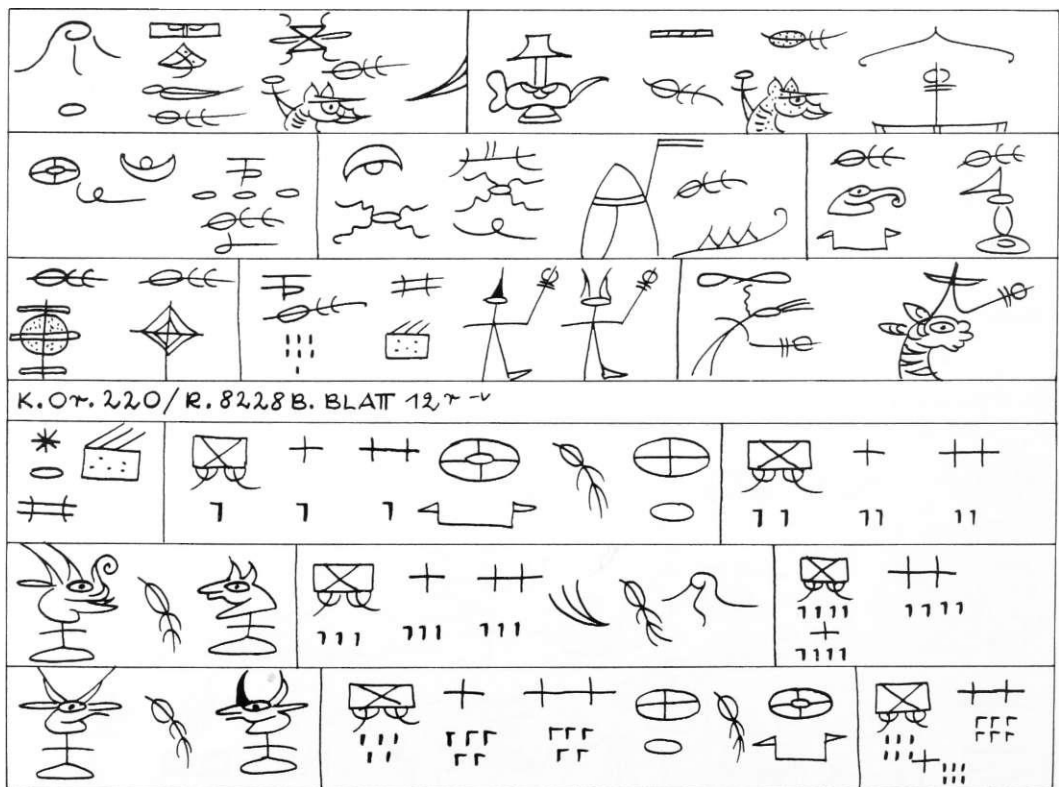
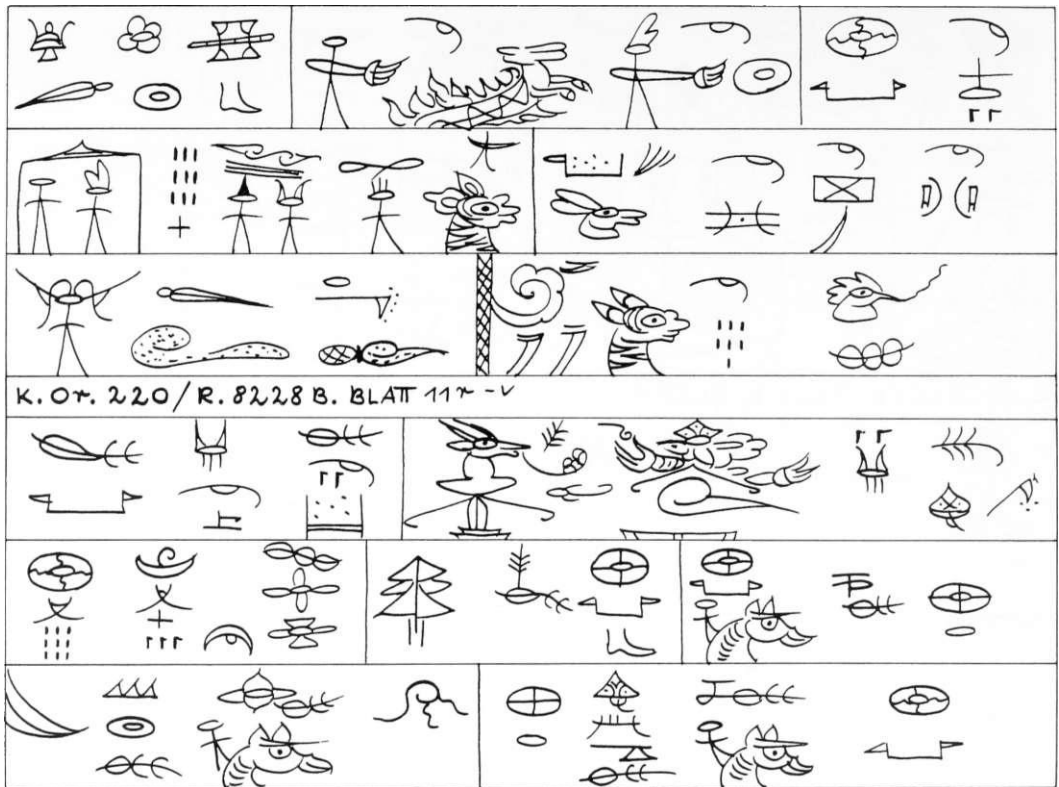

		i r i i 'Mi MII
	III III III	" ©
JL_ ^ i n o o o o r ^ - -J- <Sa.		
K.OY-. 2,2,0/ IB. 8%>%8 B. BLAT 3		
^ ← ^		
V / * x ' M I		

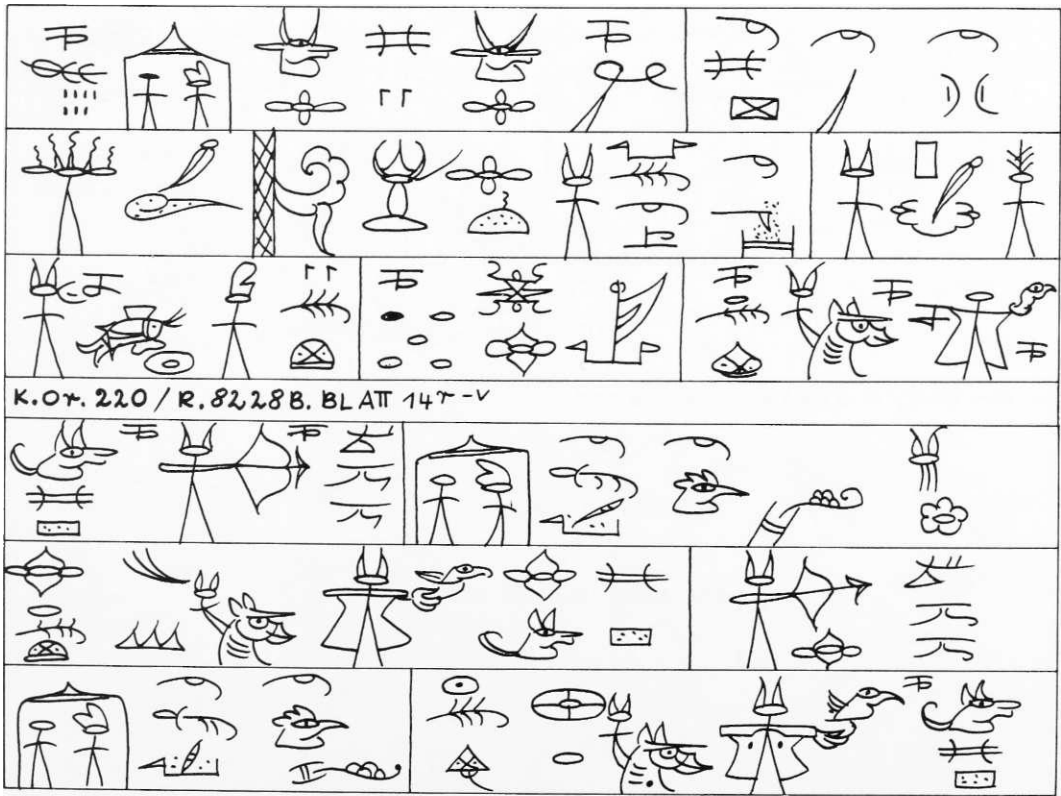

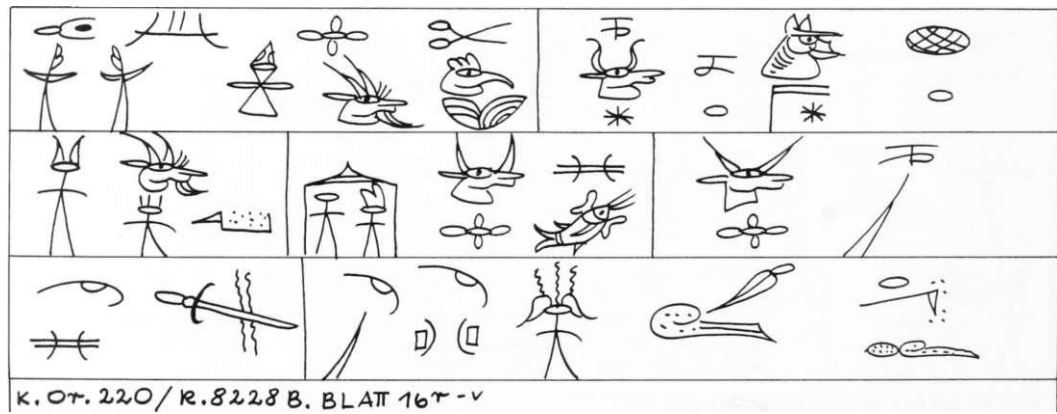
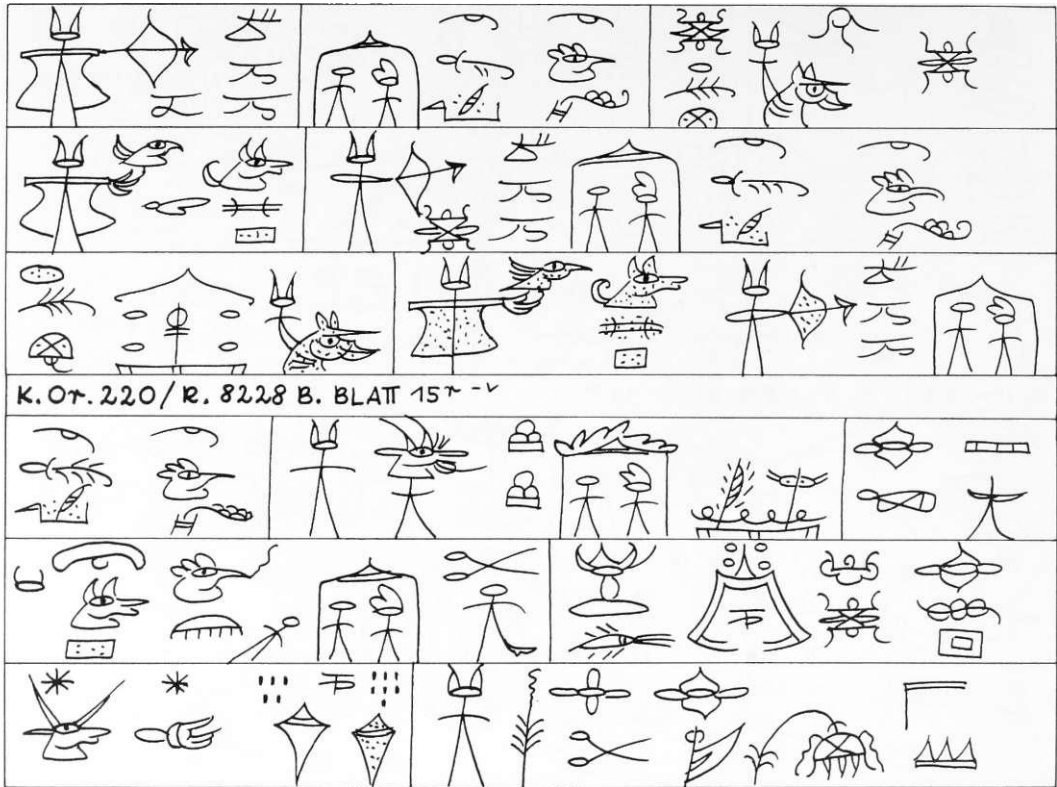

Diese SEITE IST NICHT BESCHRIEBEN

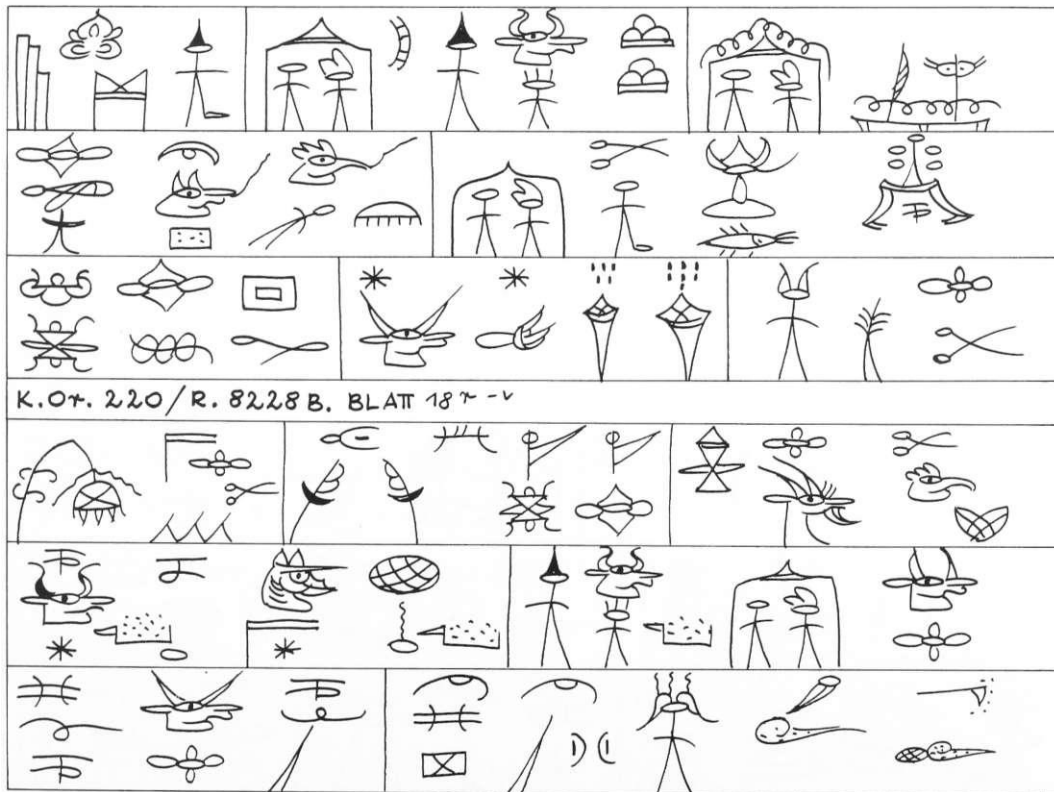
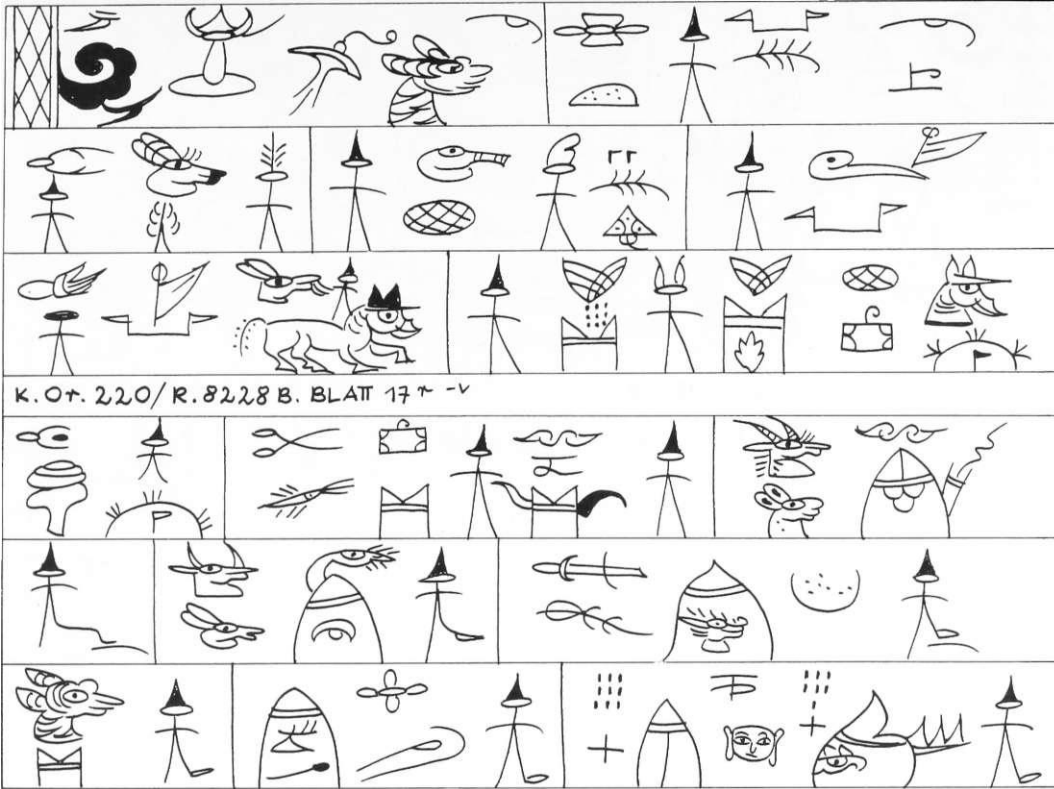

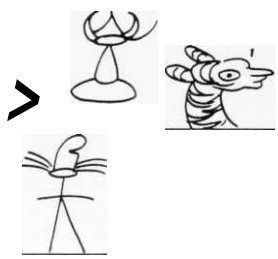

l g * * * -

i i
+

K. Or. 2/2,0/K. 8U8B. BLAT 19~ "

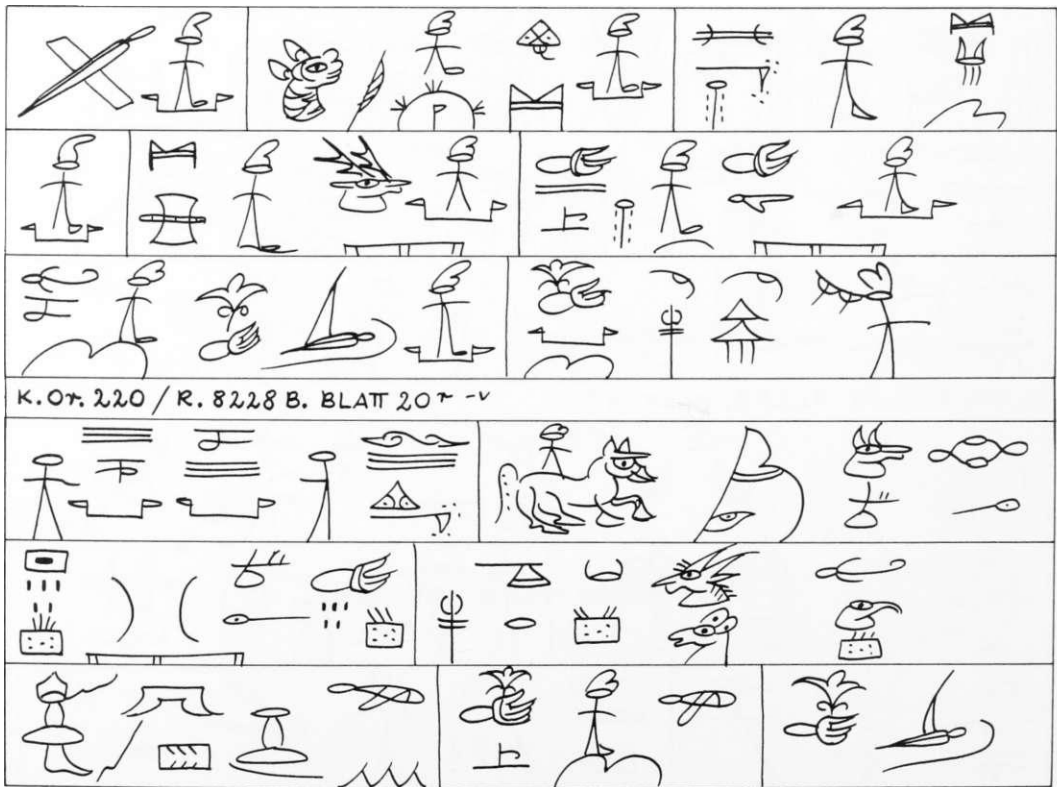
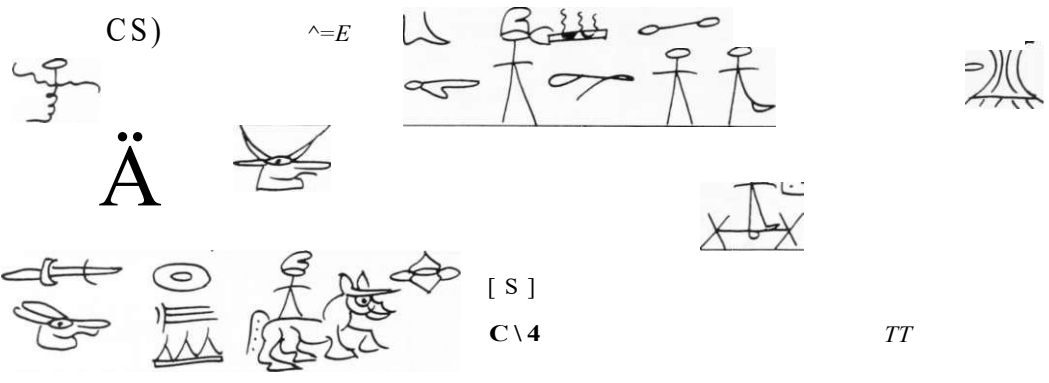

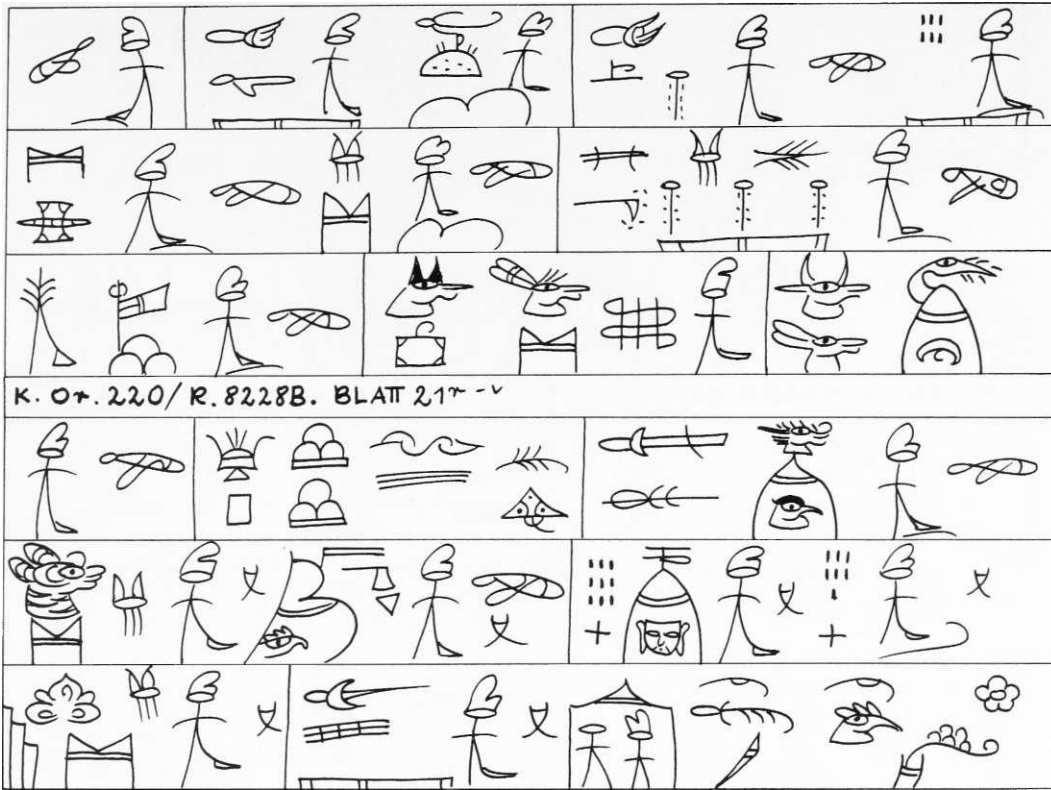

K. O+ . 220 / R. 8228B. BLATT 21^{r-v}

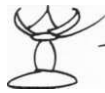

lk
11 •
+



β .



2 ^
11
11

i • i
11

K.OY-. %%0/ ie. S ^ ff B. BLATT h%*

_T3



3 = S

^3



IUI A



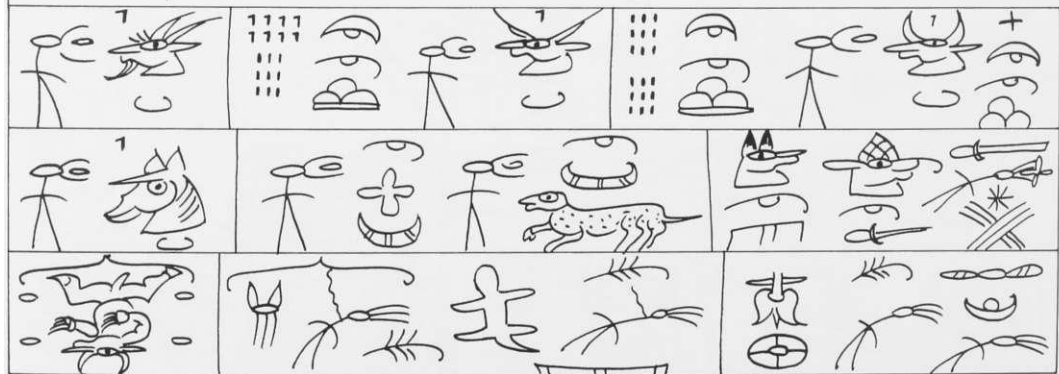
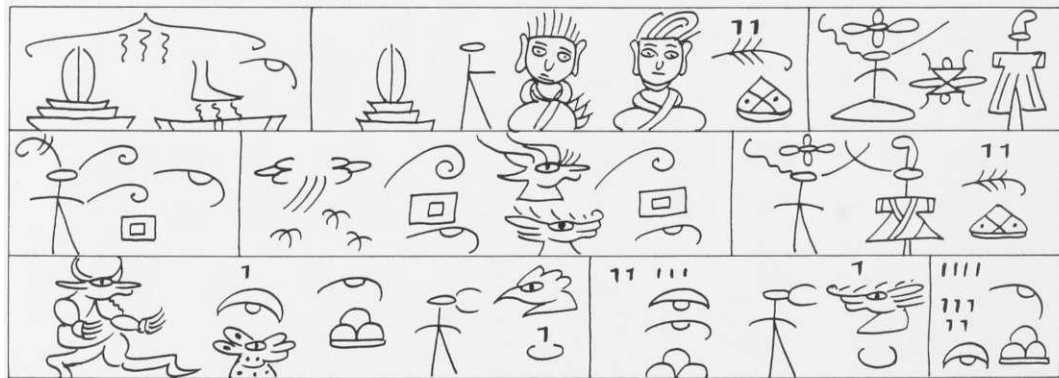
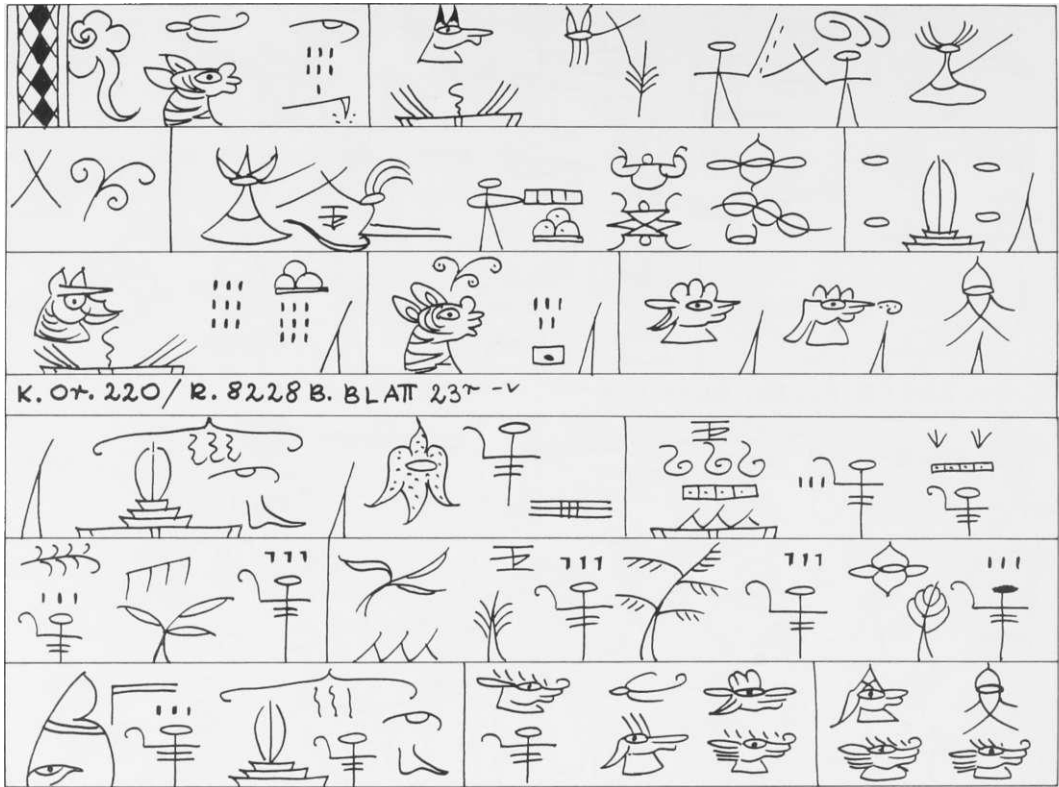

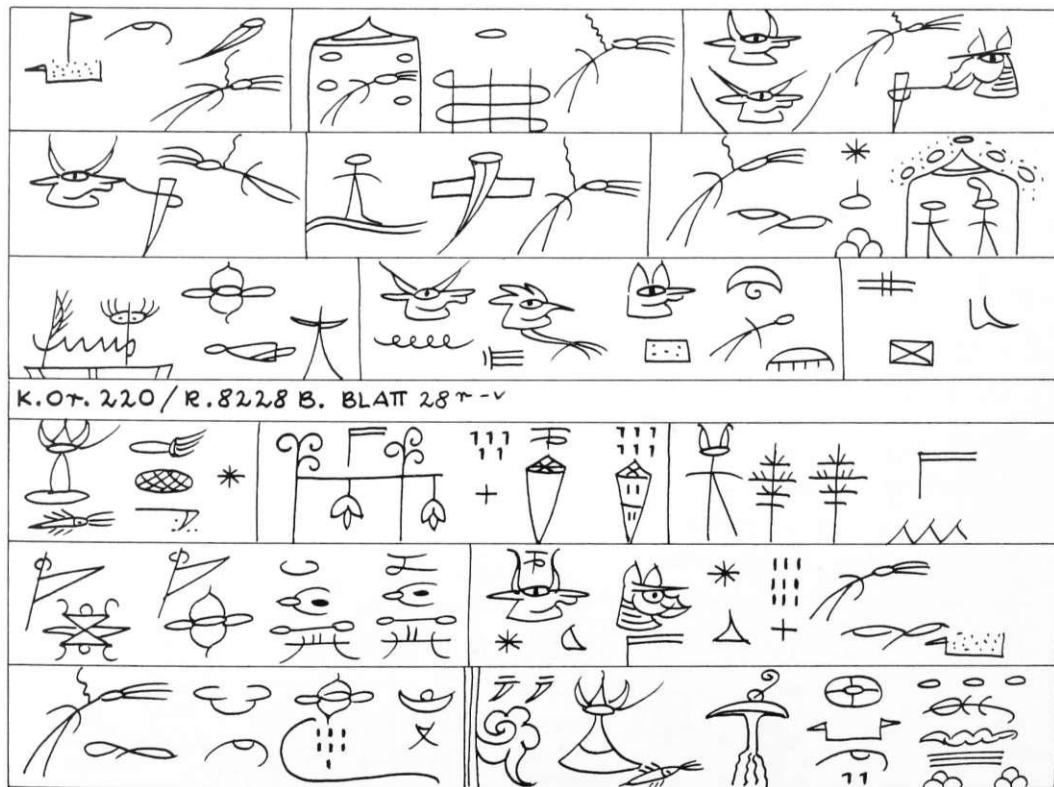
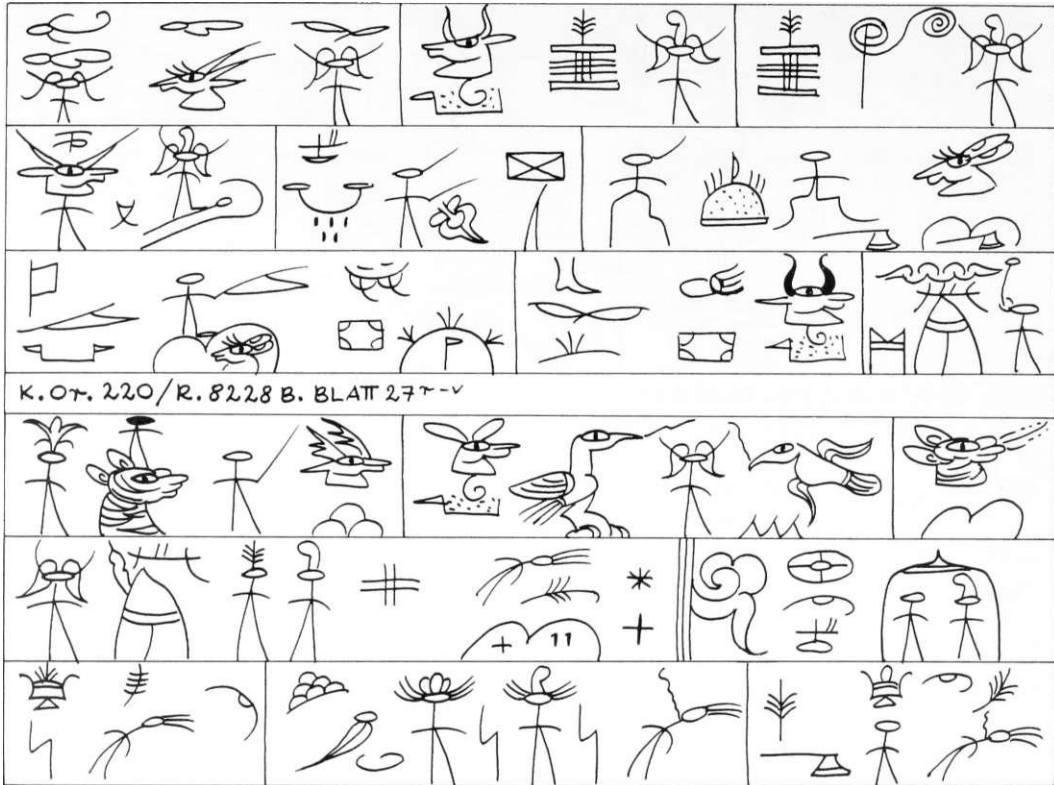



-1_____r

-TT;:, rr



K.01-; ;U-0/ K.SXiSB. BLATT 2-9"

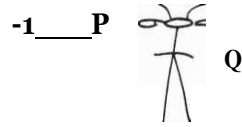
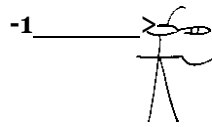

III
III

i11 *Z1i* + ^
± 1 fed v

II I
III

7V



t

i 11



I II

III

..I

IM

K. OTT. 2,2,0 / B. #2,2,8 B. BLATT 3** - -

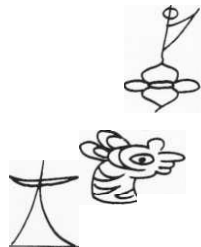

3^



^

L S

99



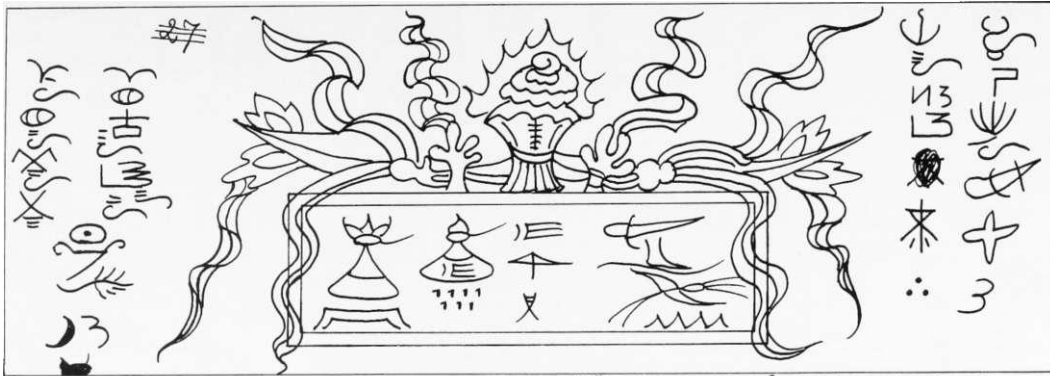

XIII, 97, 1 - Hs. Or. 534 / R. 8234 A. Hār-la-llū kō. Ssaw-yi-wūa-de ssaw.

BLATT 1^{r-v}

ROCK: a * *PI* I L

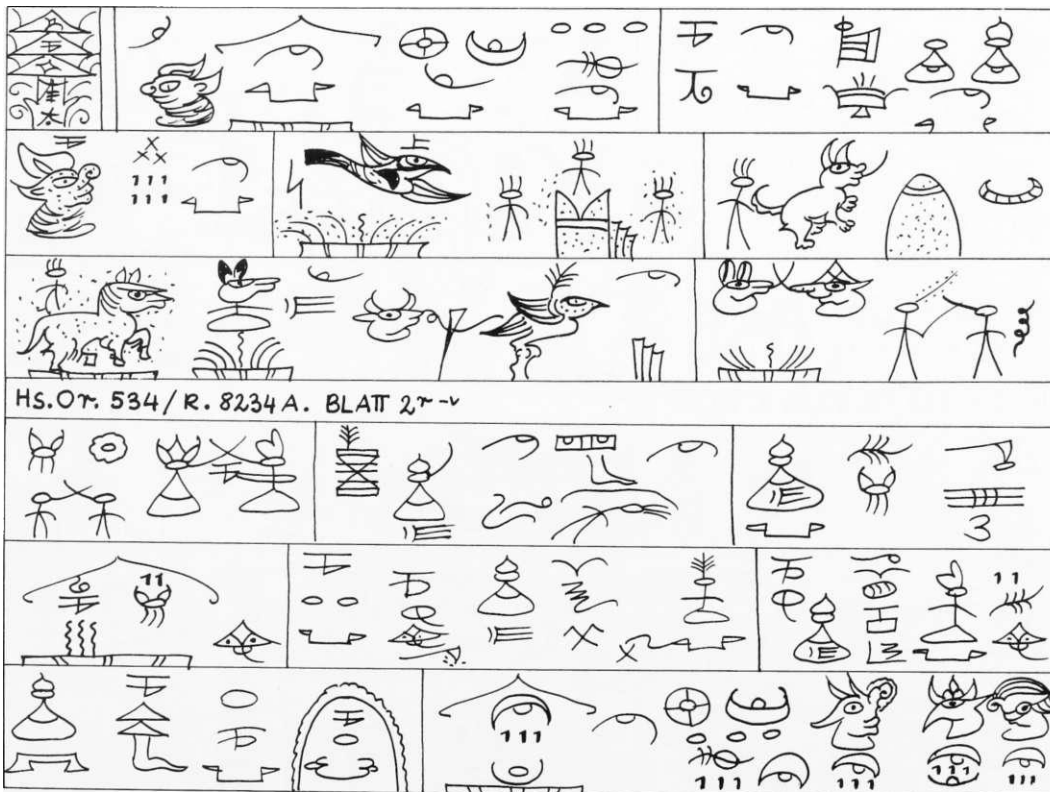

Hs. Or. 534 / R. 8234 A. BLATT 2^{r-v}

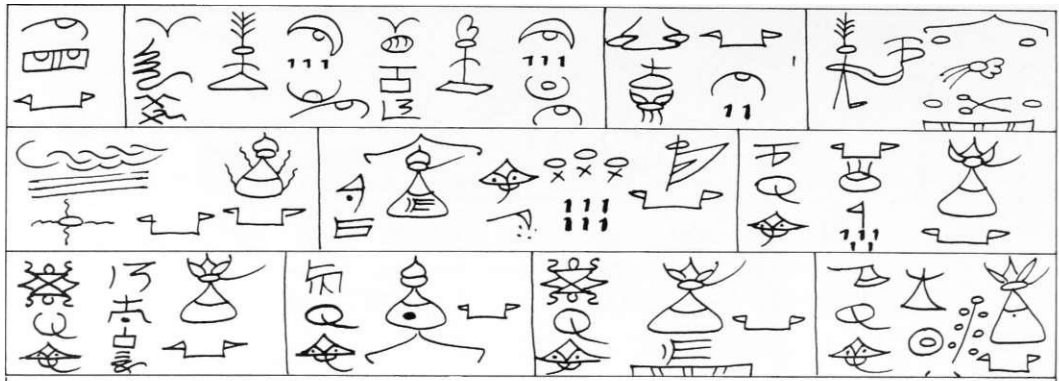

HS. OT. 534 / R. 8234 A. BLATT 3r-v

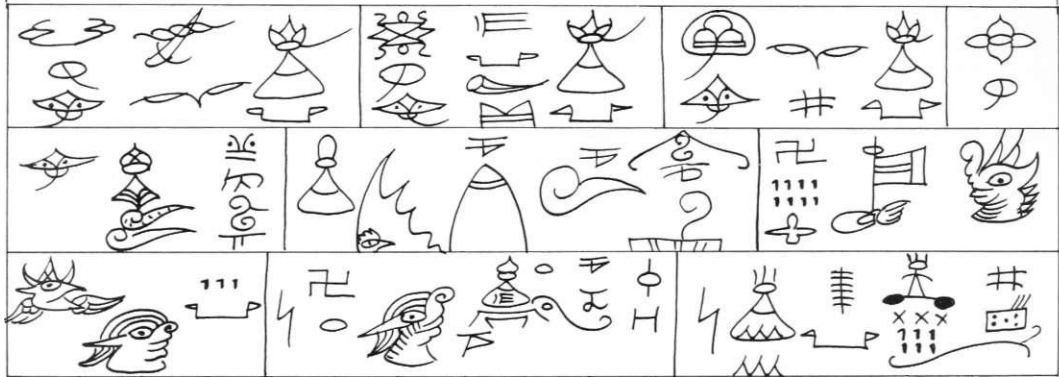

HS. OT. 534 / R. 8234 A. BLATT 4r-v

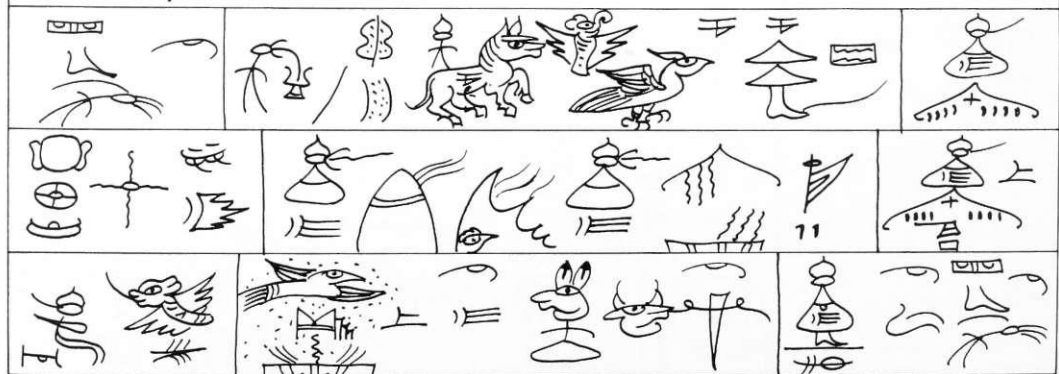

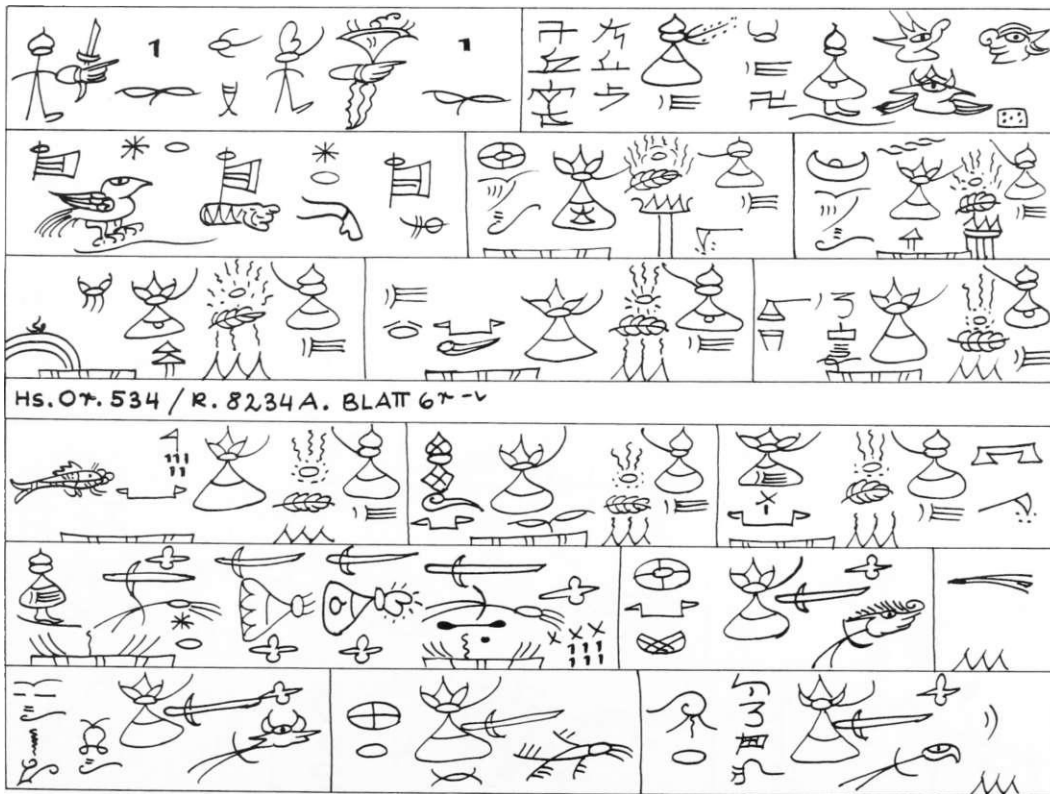
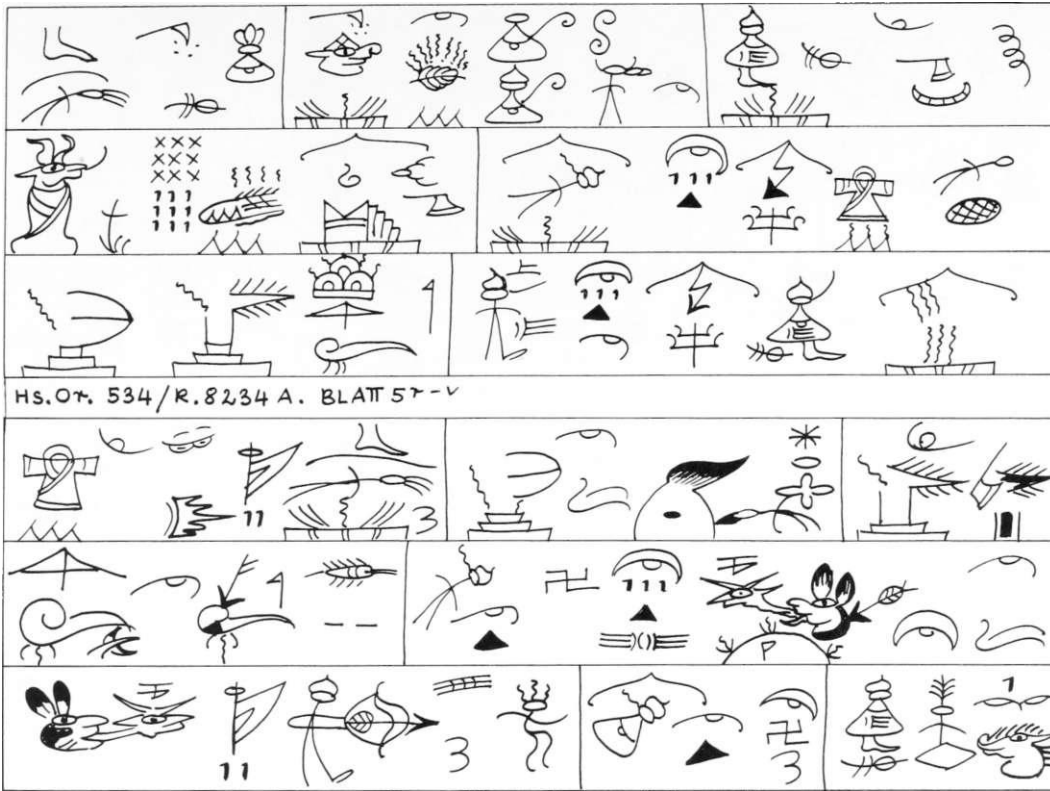

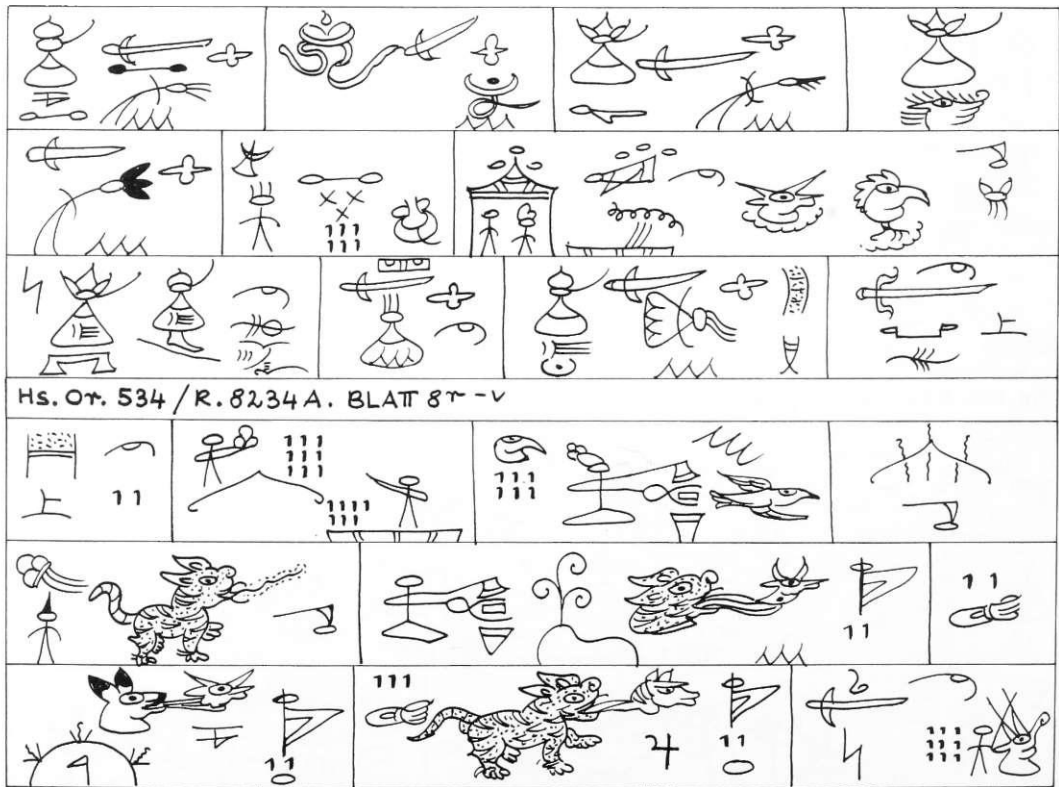
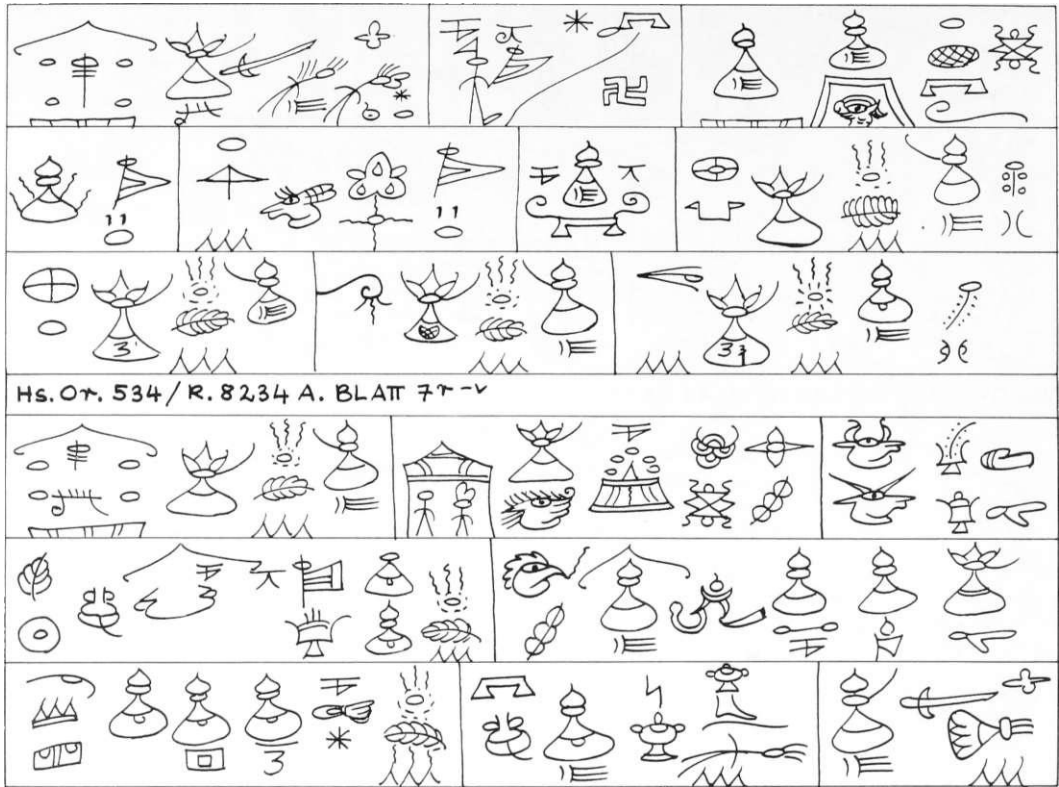

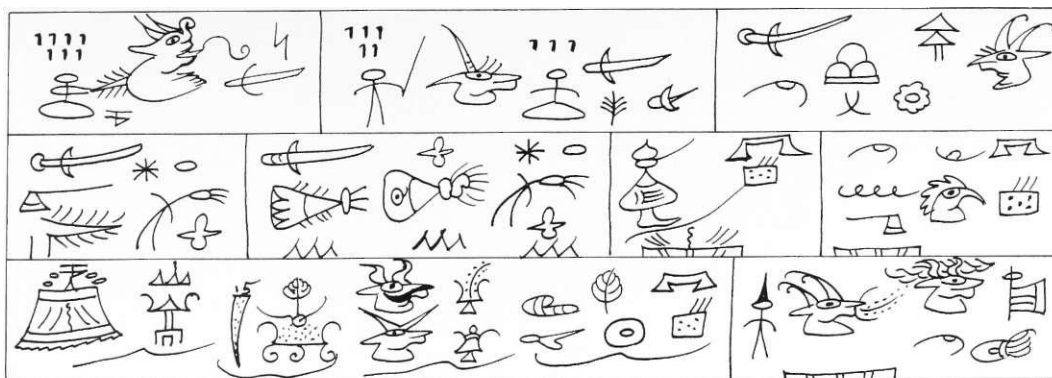

Hs. Or. 534 / R. 8234A. BLATT 9r-v

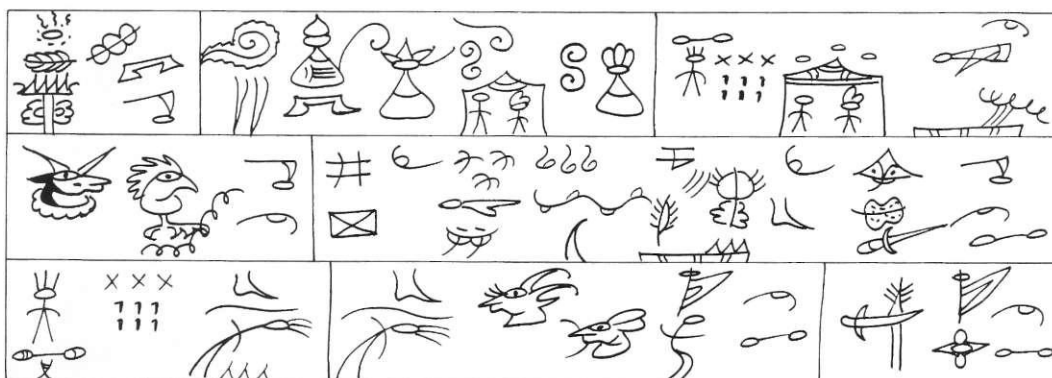
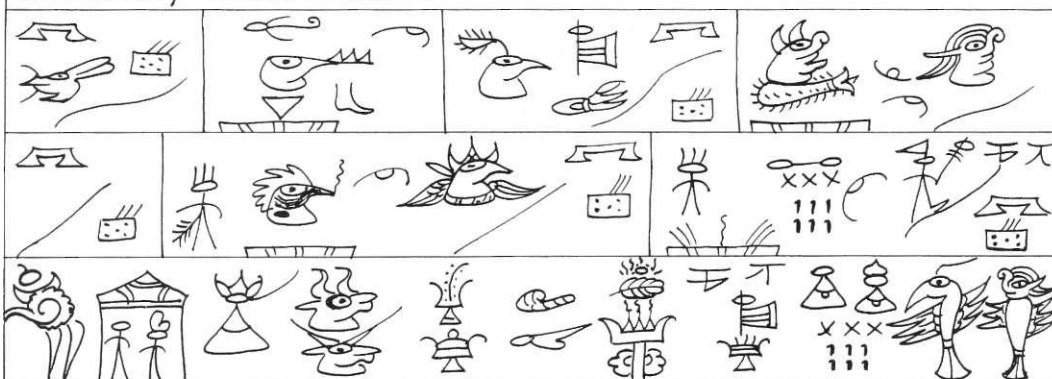

Hs. Or. 534 / R. 8234A. BLATT 10r-v

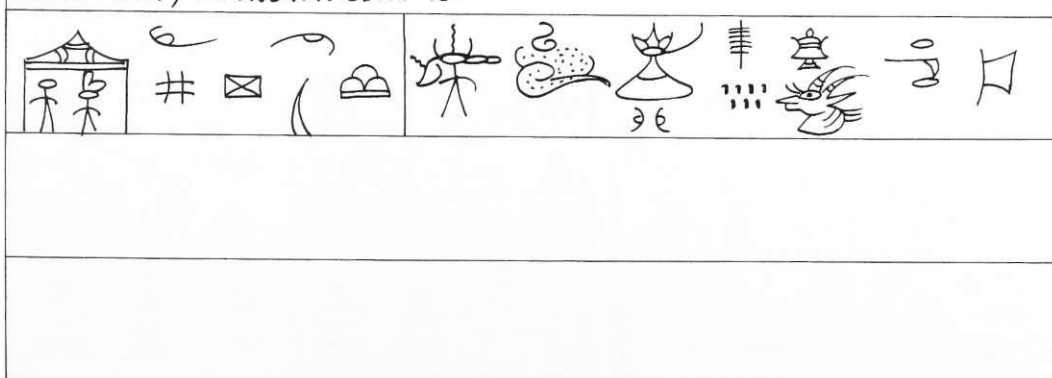

TITELBLAT FEHLT

xiii, 9^ l - HS.OT-. sim. 542,/ft.51io. Hdr la-llü.fe'ö.Dtonate'ö.Ssau-yi-wua-dessaw.

BLATT-1



UfM ^ ® * o

\ t-n-7 /

Hs.OT-. sim. 542,/R.S"110. BLATT ^ -



3

ft/*- o o
 \$ r



CID



Hi

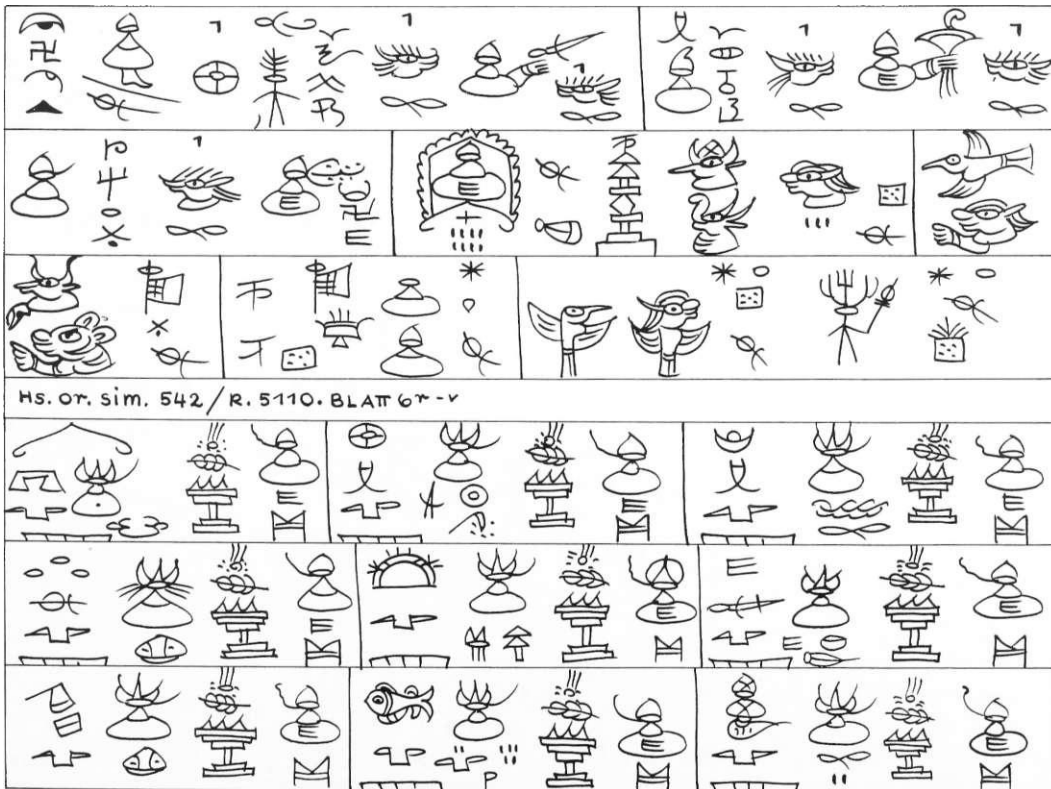
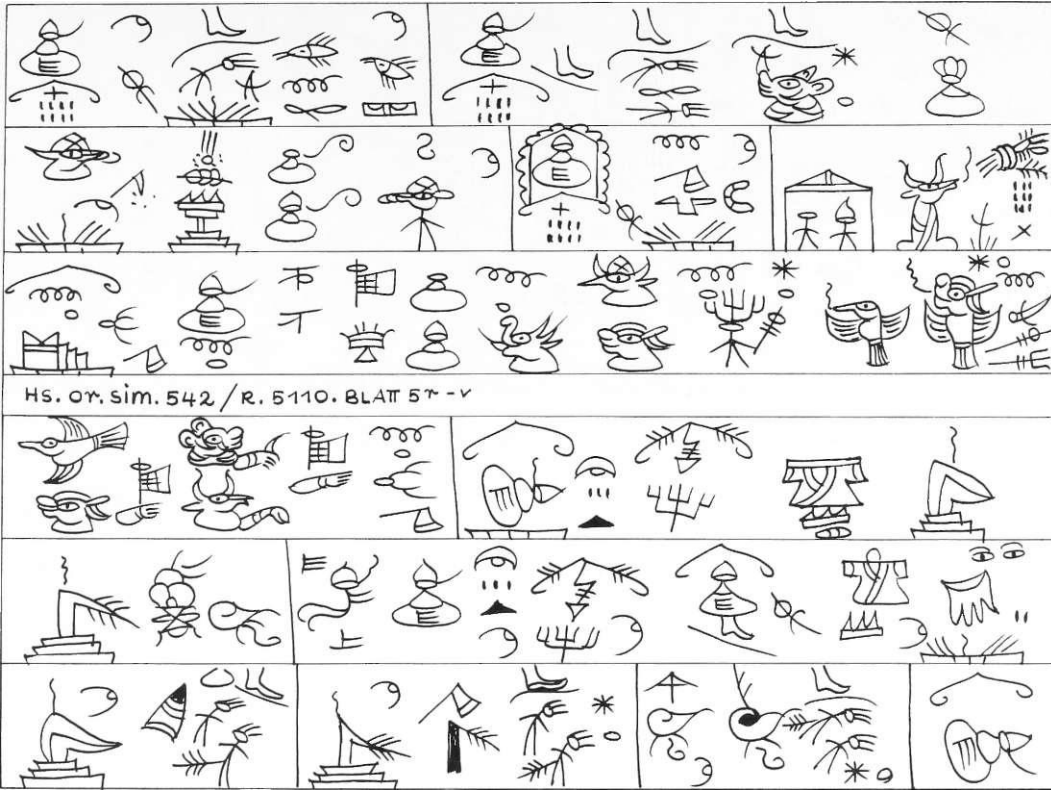

v	<±E>	:sL		*
◊	^	^	o	
Hs. or. sim. 542./B. 5110. BLATT - v				
^ ±. ®		←=^		•••
			HL	^
> «Ö? I ^ © © = > ^ = ^				

2 ^	v.'Tgr	^ rrrr-i 1^4	(g\$ CHH <^
			p
UM)			

Hs. or. sim. 5110. BLATT8^ - V

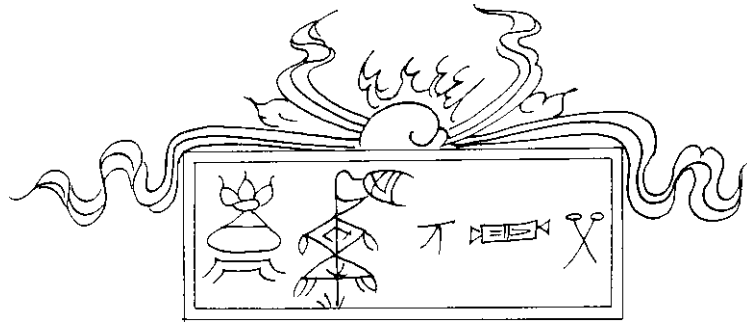

XLIII, 9?, m - HS.OY-. 350/R.5-113. Hart- La-LLu k'o. Ndsher tsagkyi. BLATT

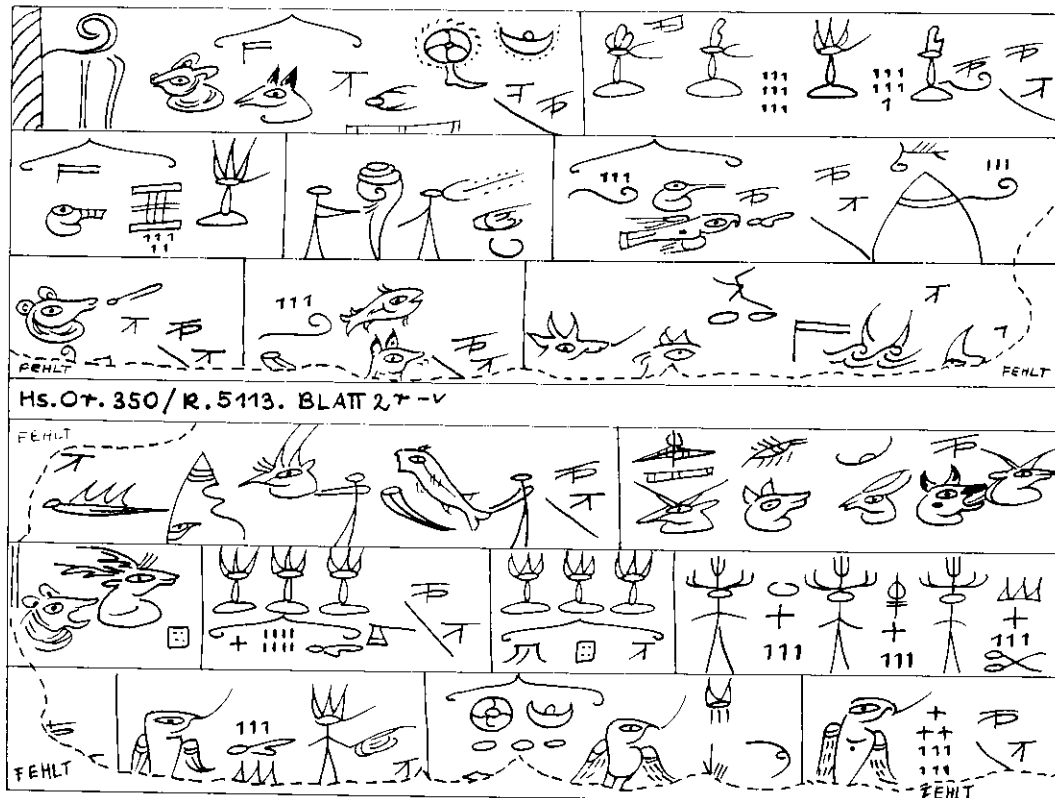
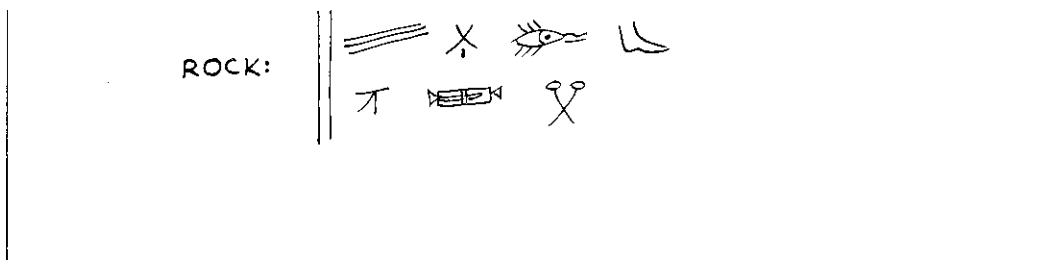

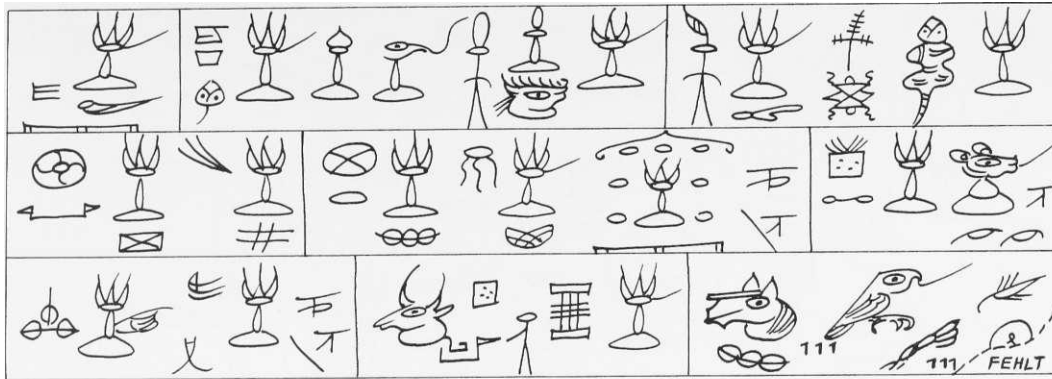

Hs. 07. 350 / R. 5113. BLATT 57 - v

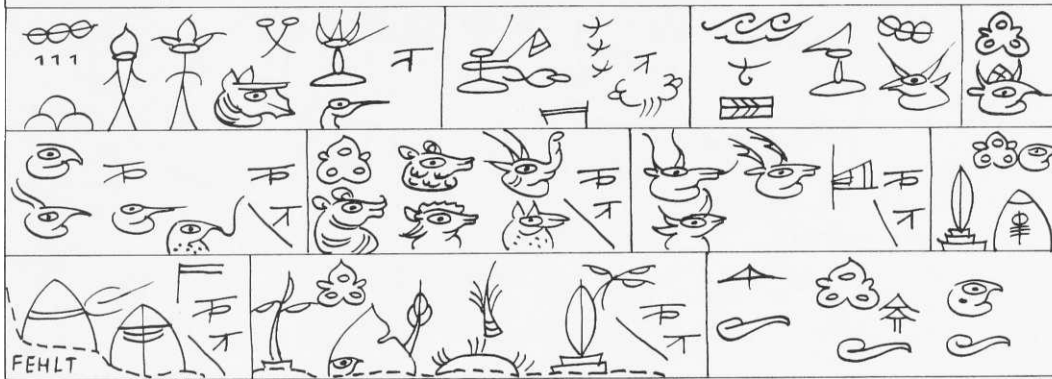

Hs. 07. 350 / R. 5113. BLATT 67 - v

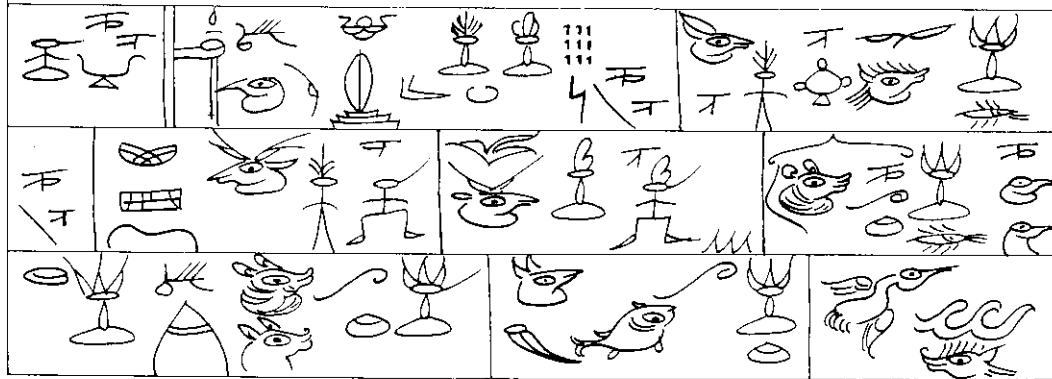

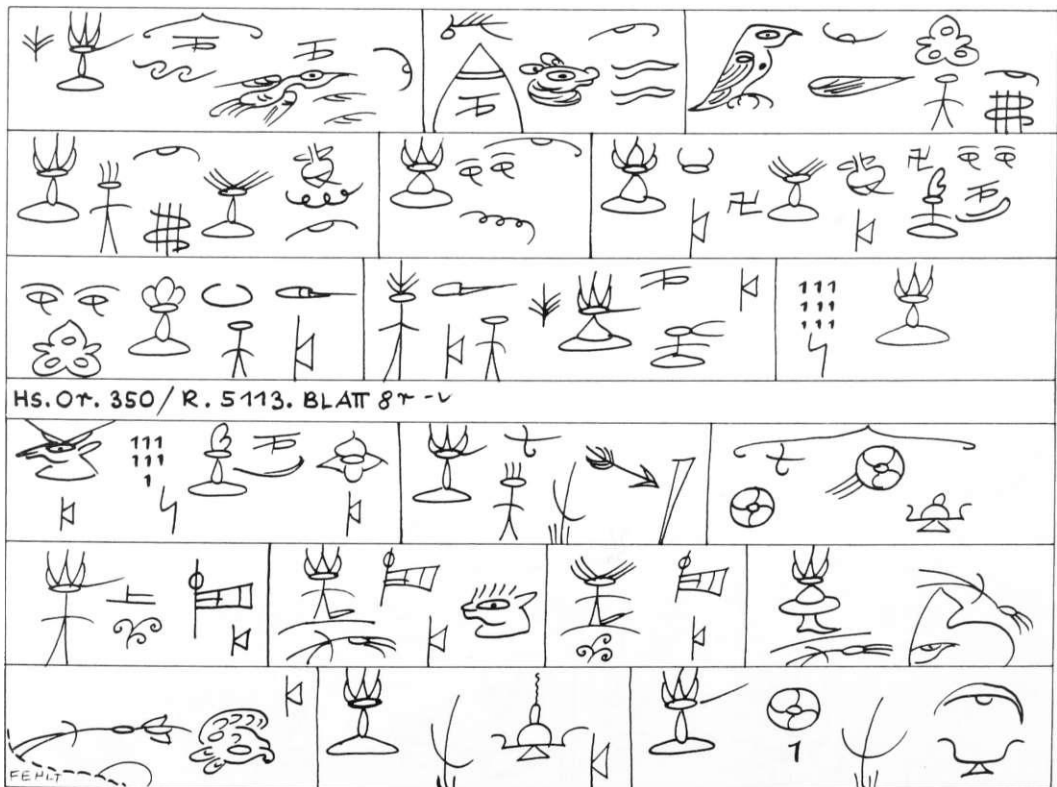
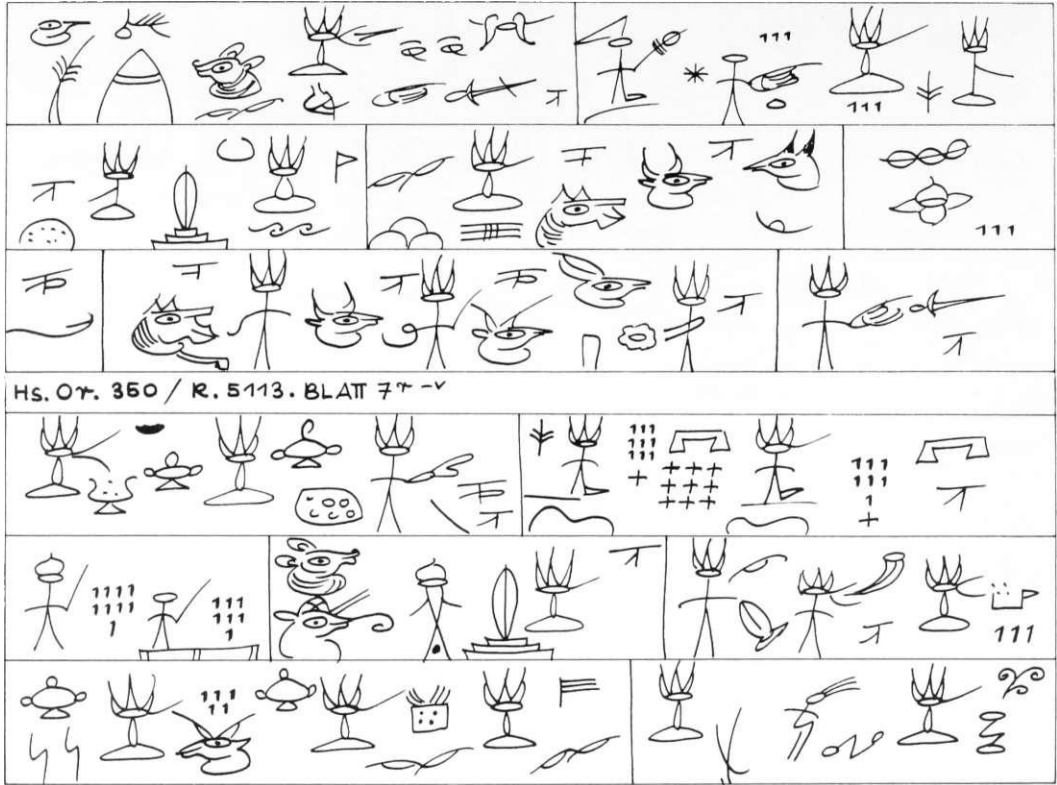

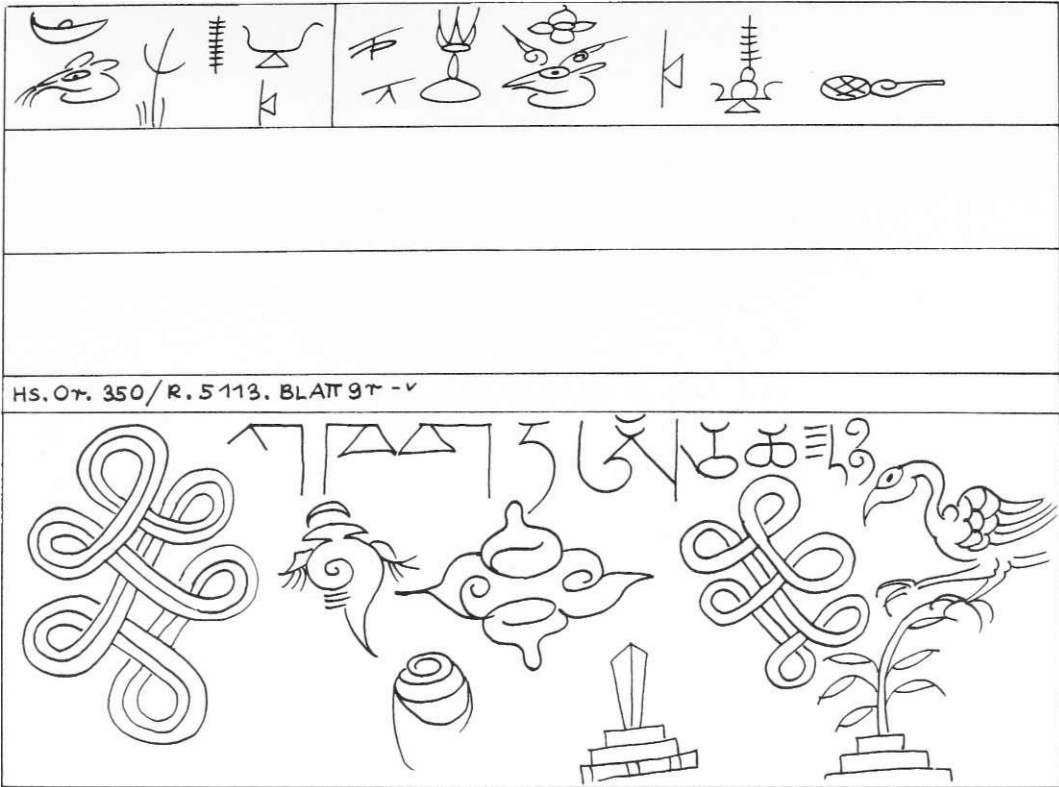

TITELBLATT FEHLT

XIII, 97, m - Hs. 07, sim. 544 / R. 5112. HÄR LA-LLÜ KÖ, NDShĚR TSÀ GĚYI. BLATT 17-v

ROCK: || ≡ × 𐀓 𐀔
𐀕 𐀖 𐀗

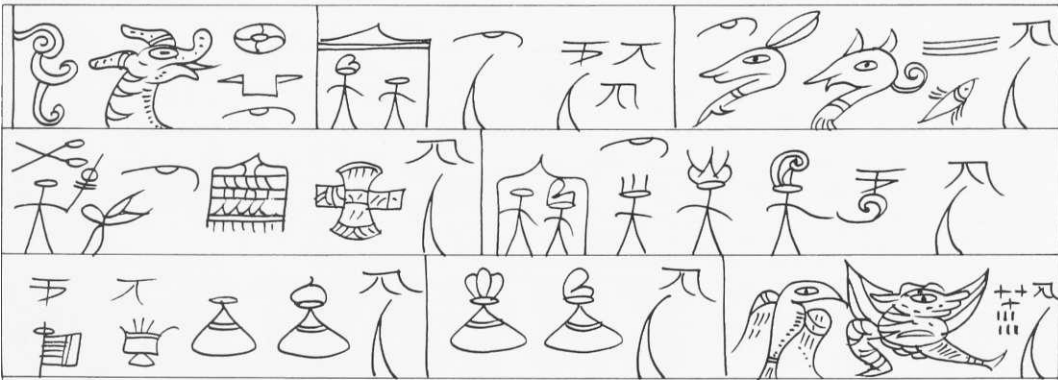

Hs. 07, sim. 544 / R. 5112. BLATT 27-v

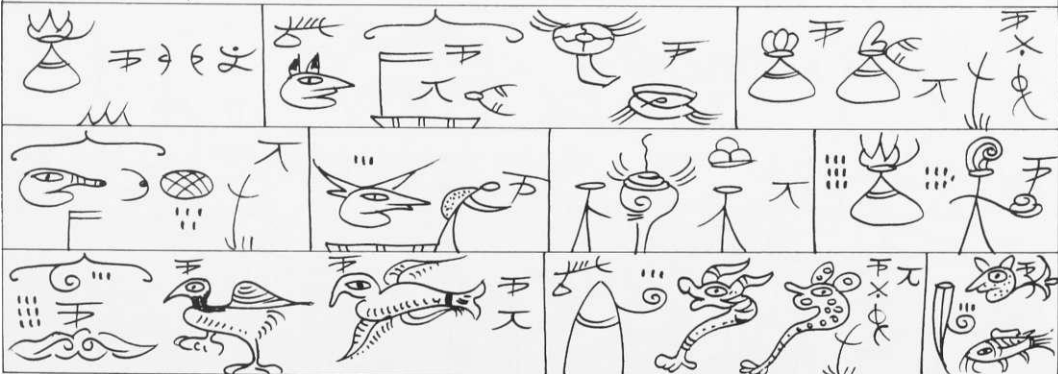

			T ^ ^ y ^ ^
			3? _ ^

| Hs. or. sim. 54^/R. 5-112.. BLAK ar--v

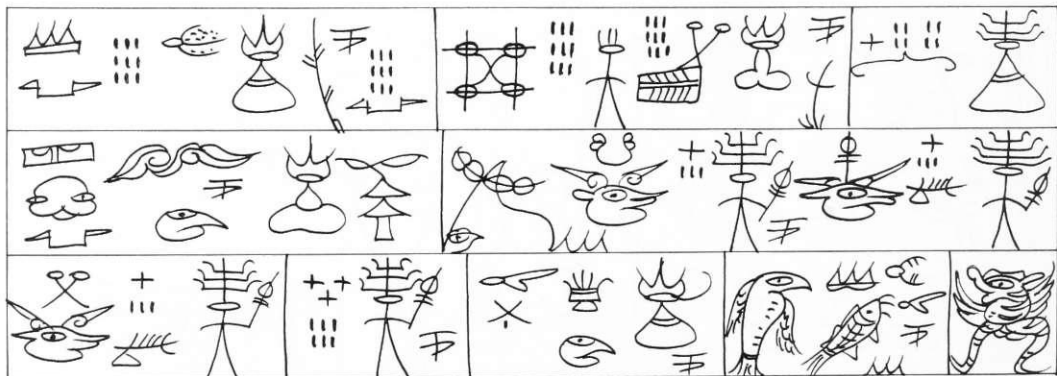
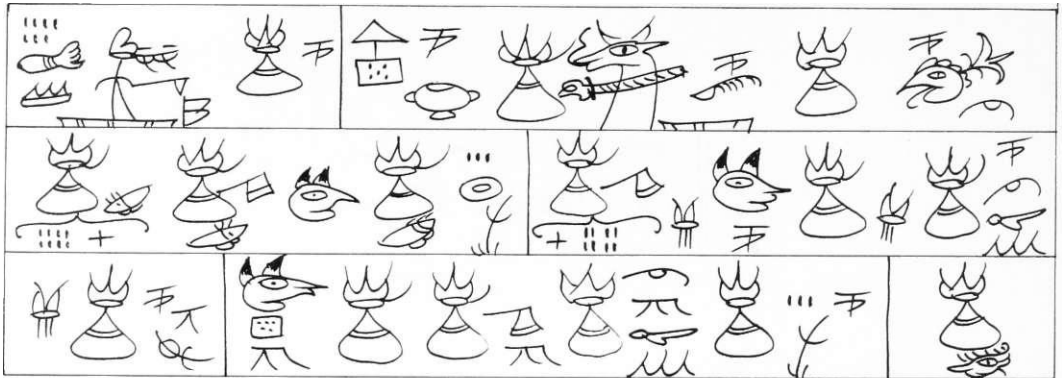

Hs. or. sim. 5H4/R. **BLAT 1**>-'

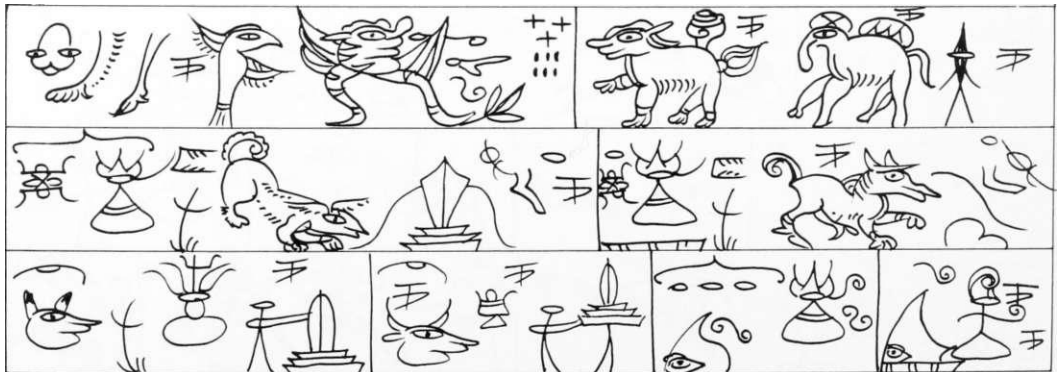

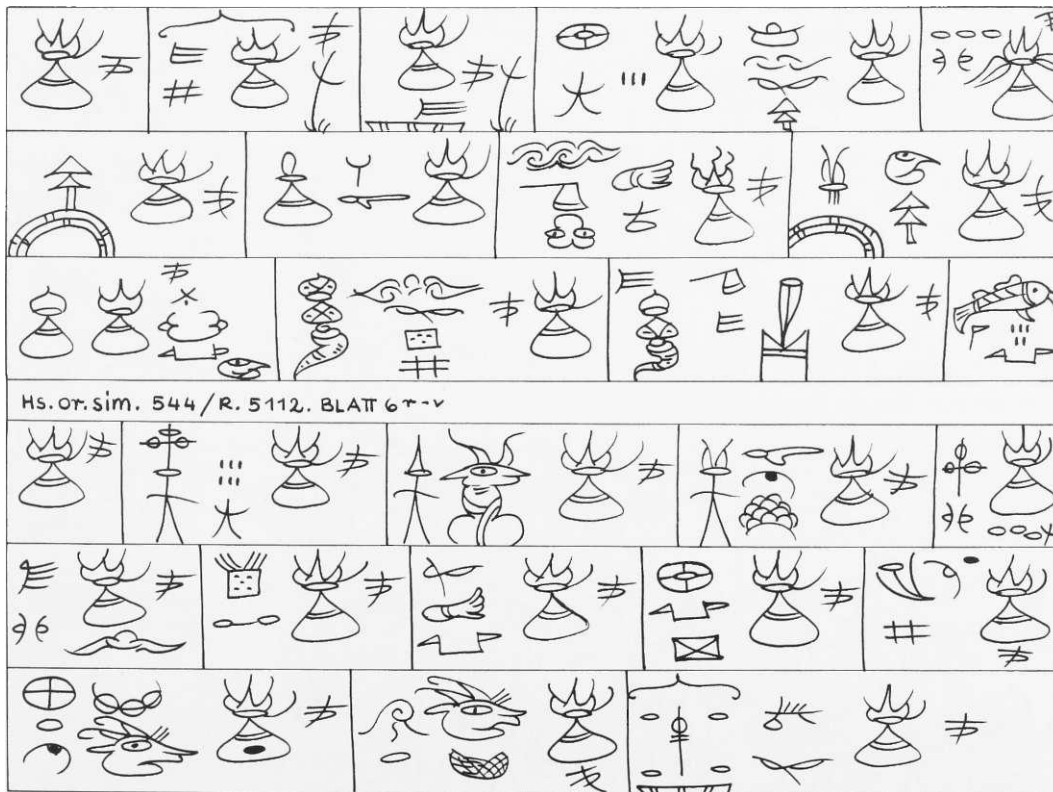
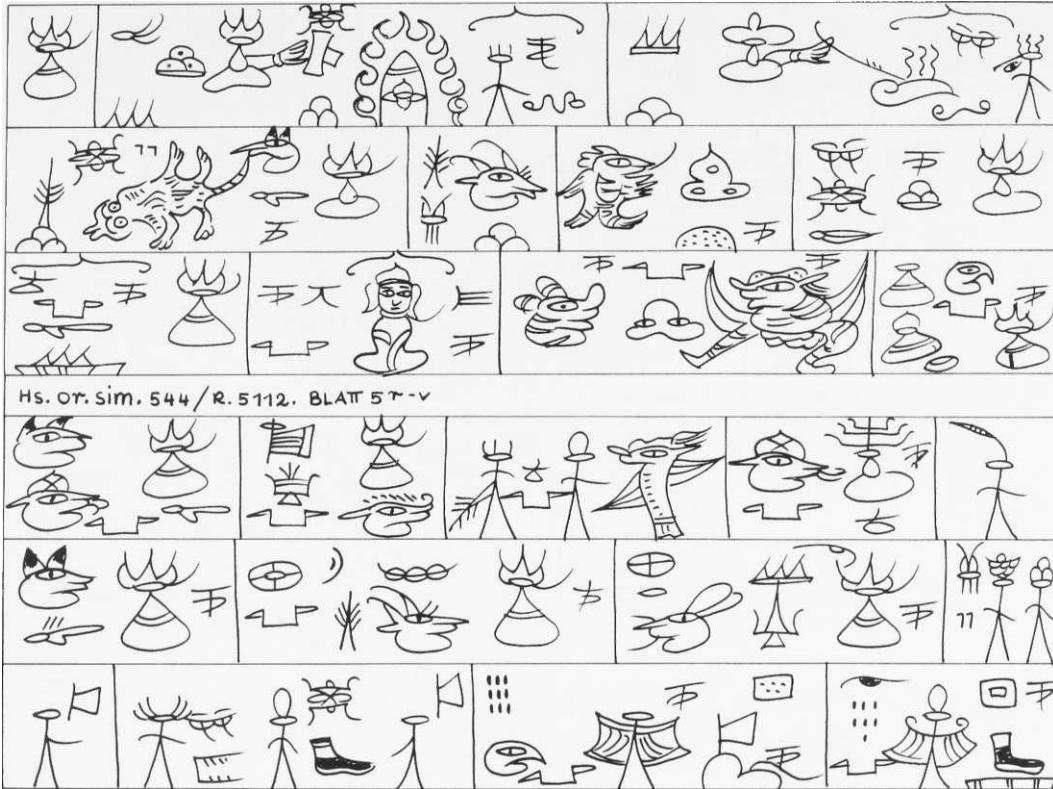



Hs. Or. sim. 544/R. 5112. BLATT 7r-v



Hs. Or. sim. 544/R. 5112. BLATT 8r-v

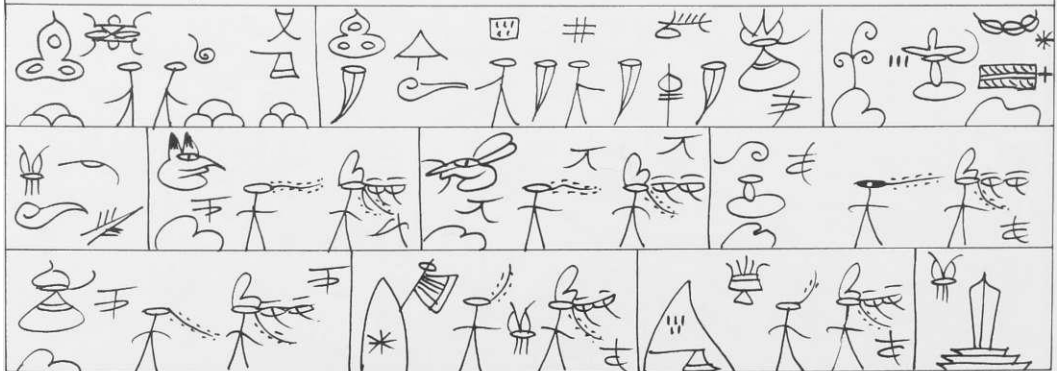

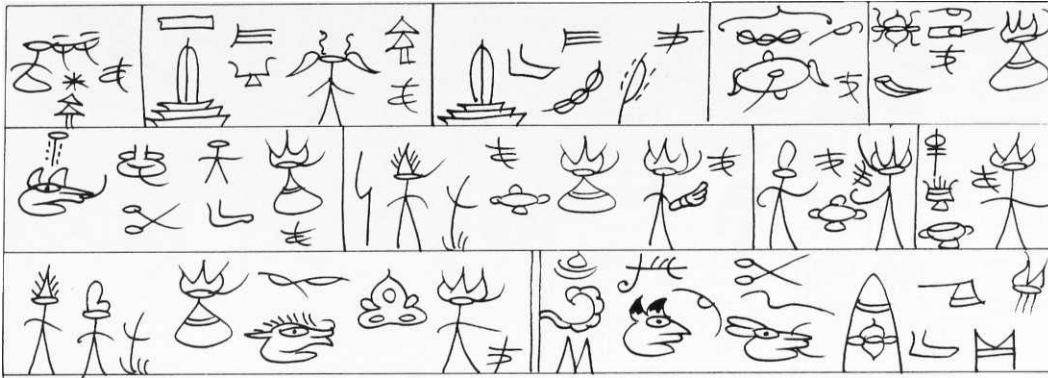

Hs. or. sim. 5^4/R. 5112.. BLATT 9^4-^

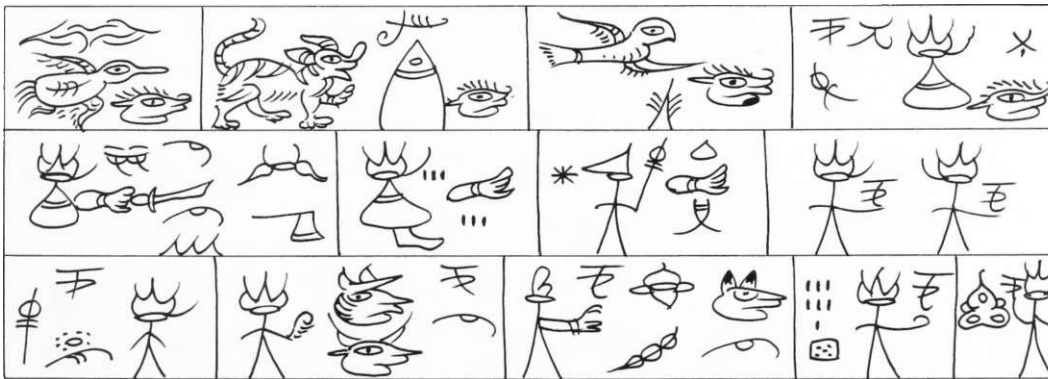
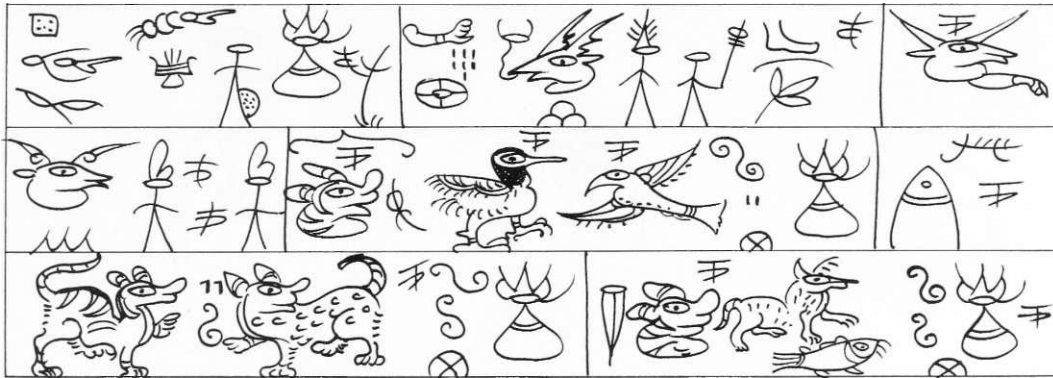

Hs. or. sim. 544/R. 5112. BLATT 10^4-v

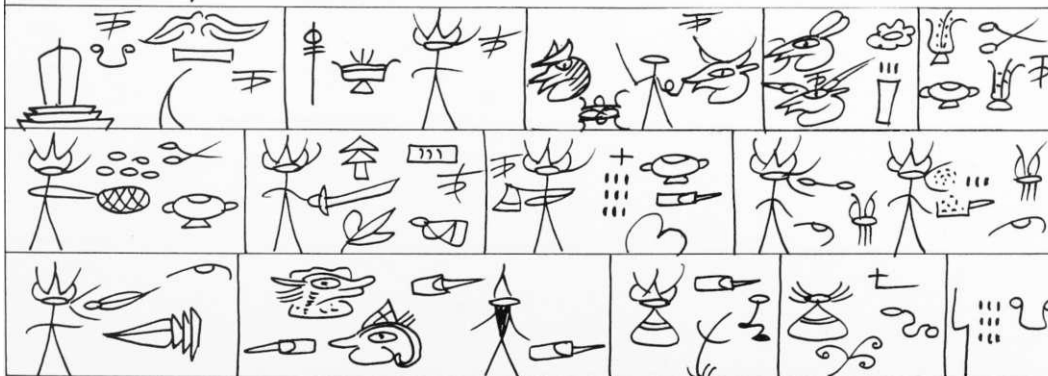



HS. OT. SIM. 544 / R. 5112. BLATT 117-v



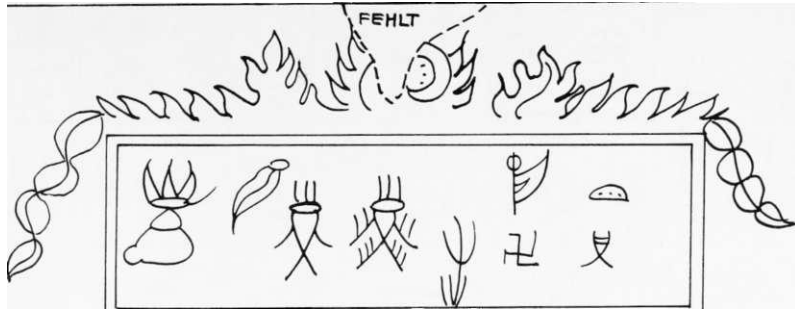

XJU,9?.n - K.Qf- LkZ./K.8l8Z.H&rl<x-llhko.Gyi Mun QhügH bpö. BLATT i^

ROCK:

ti//

» I i i M		
K.OV. 2.1ti/R.8iyi. BLATT 2"-		

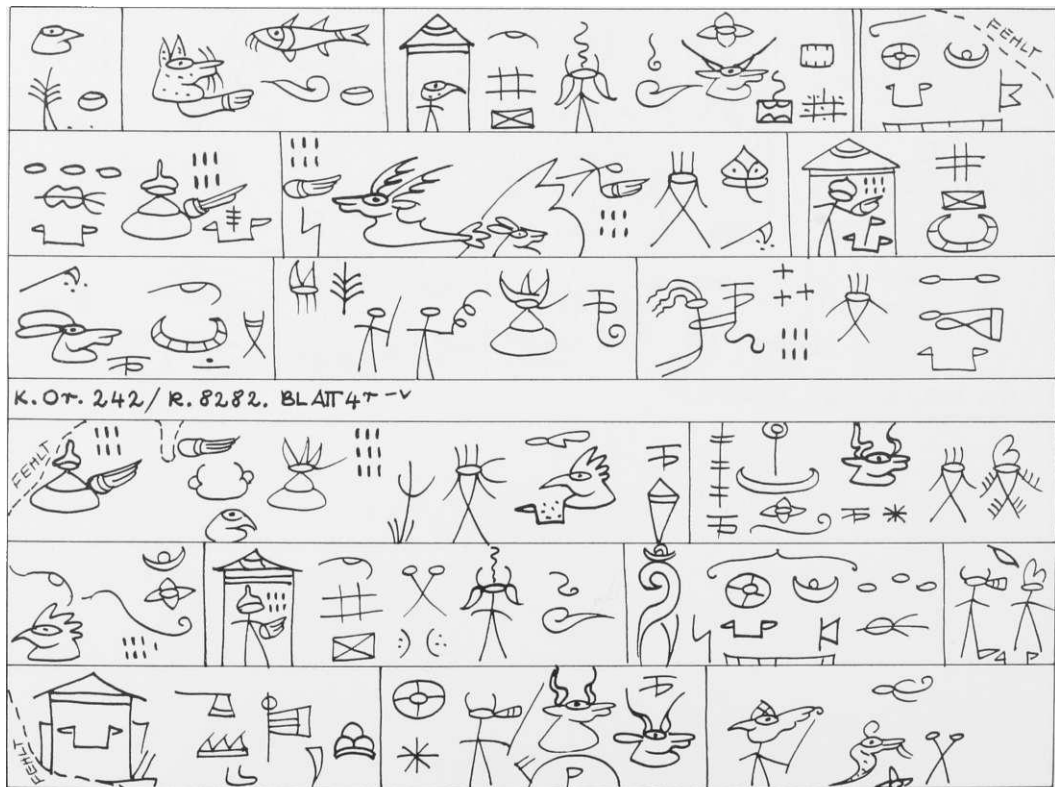
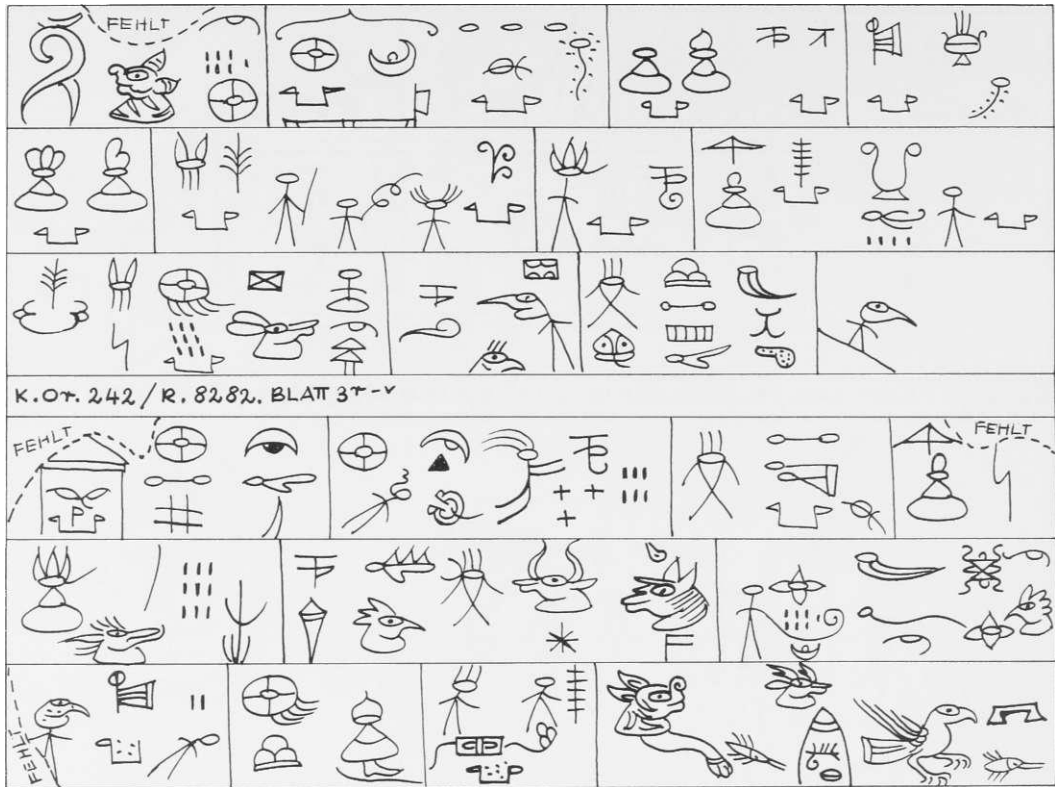

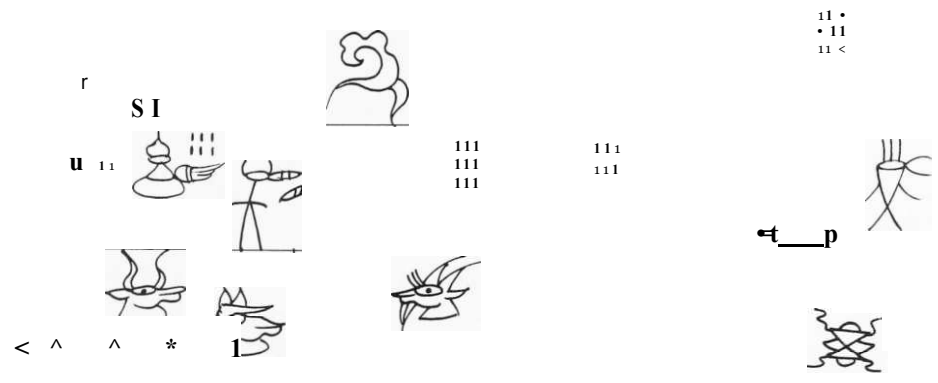
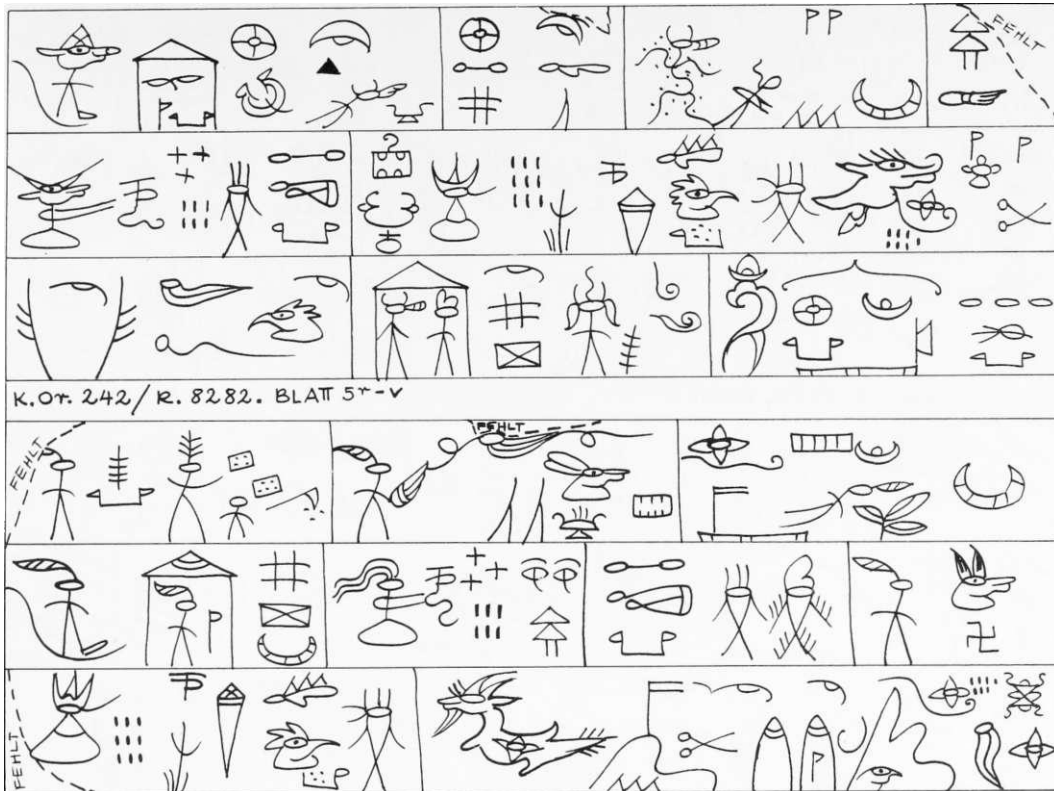

K. Or. Zt+Z/VZ. 8281. BLATT (b'' ^

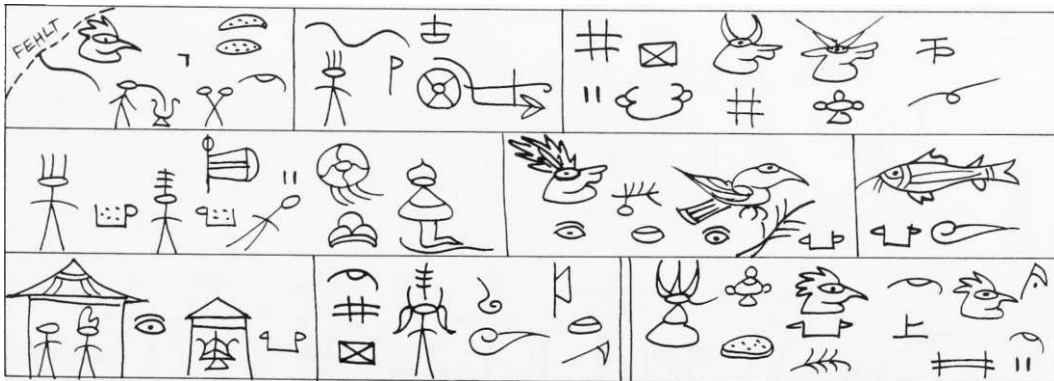

2///	f r j /	
E ^ L .." I I I 3 ^ 3 - *		
	ft ^	

K. Ot. ZW/82, 8Z.

BLATT 9

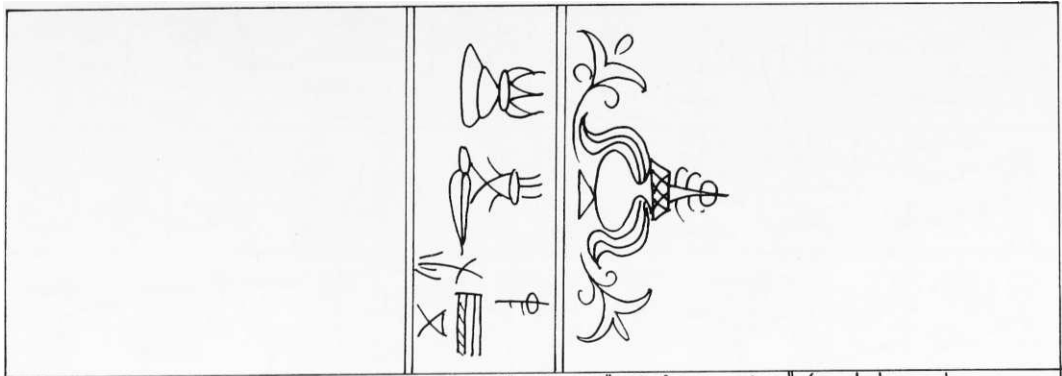

xiii, 97, n - K.O. 356/ R. 8454. Mun Ghūgh bpō, Gyi Mun bpō 'a dzhu-zhwua.

BLATT 1* -v

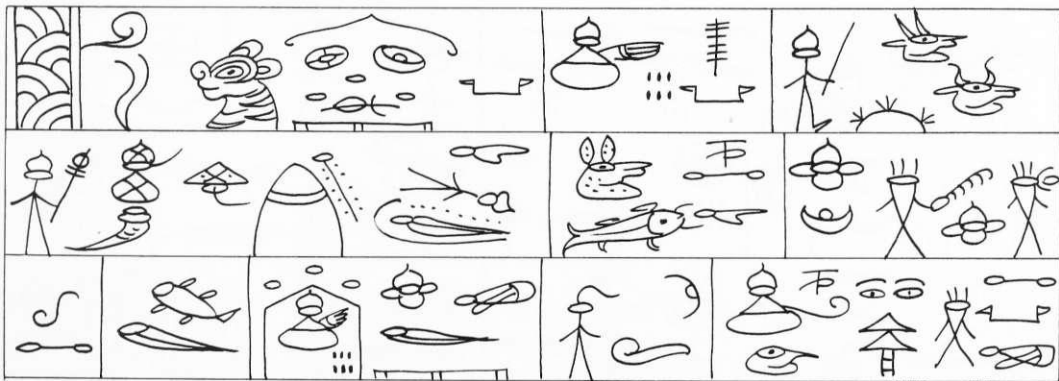

K.O.*. 35fe/fc.

BLATT 2/* ~

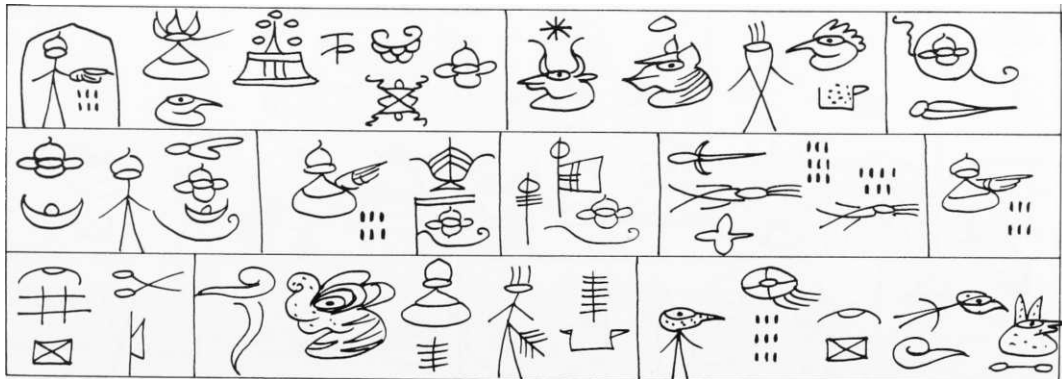

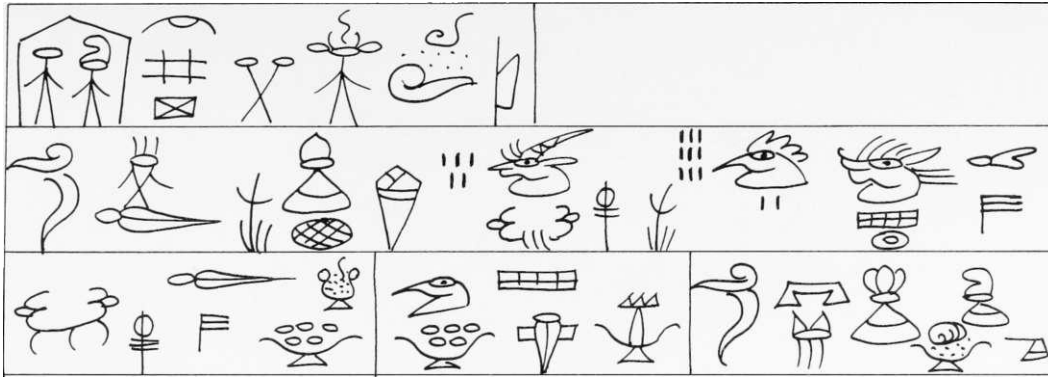

K.Or. 35*>/R. S^54. BLATT 5'



it 3tf ^

xīT, 9^ n- K.Ot. 3S?/R. ^455. HdLv La-LLu. ko. Mun Gihügh bpo. BLATT 1^
 mit xfi,105

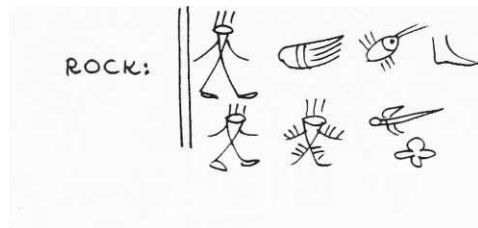

1 1
 CID -

in



& 'vir



K 0



r

K. O T. 357/R. 8155. BLATT 2,^

i(i



2 r a



...

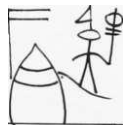

- ^ 0

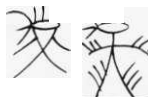

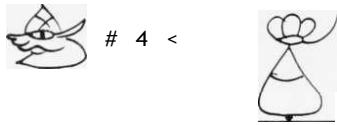

4 <

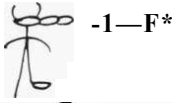

-1-F*



K.OY-

BLATS'



• 5 i



7 ^



o ° ° r



r r



9" ^ u ^ i b s



5 >



K,Ot. 35? /R £455. BLATTb*-

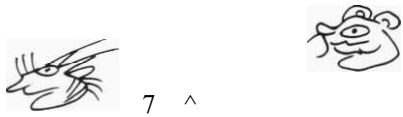

7 ^



HL



iii* 4

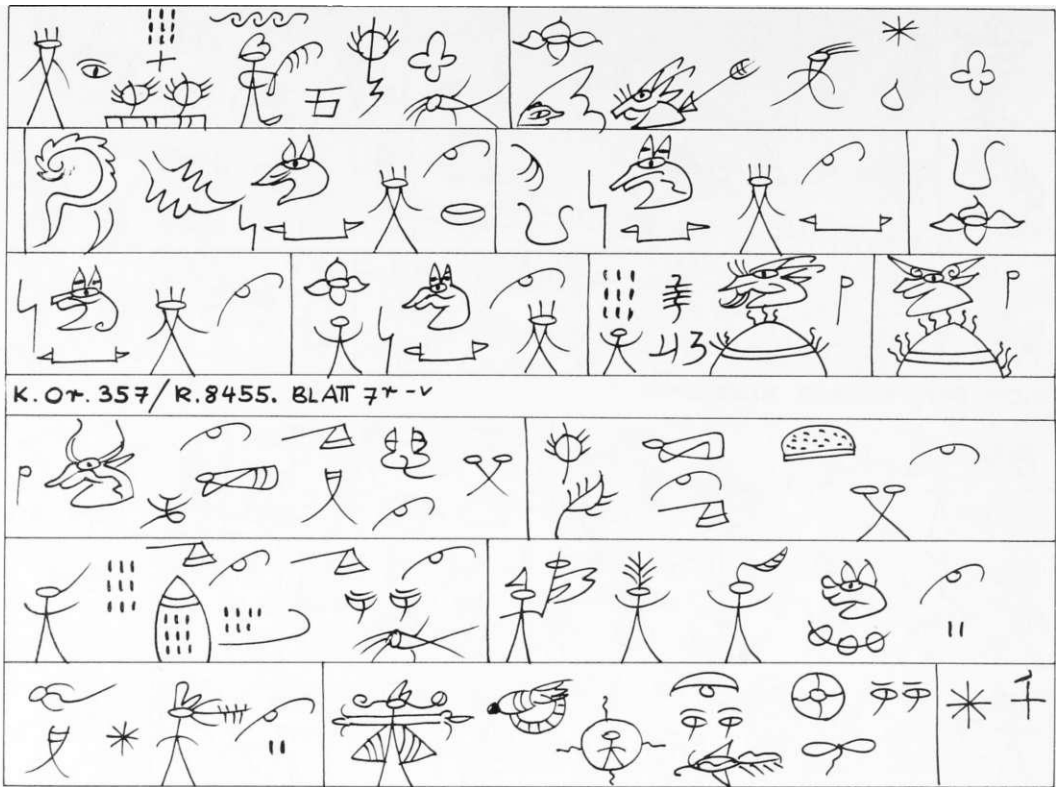

K. Ot. 357/R. 8455. BLATT 7+ -v

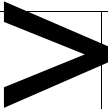
	
<p>K. Ot. 357/ft. 5455. BLATT 8^</p>	
<p>/ 2 E A im</p>	
<p>ÆT) IM 1S</p>	

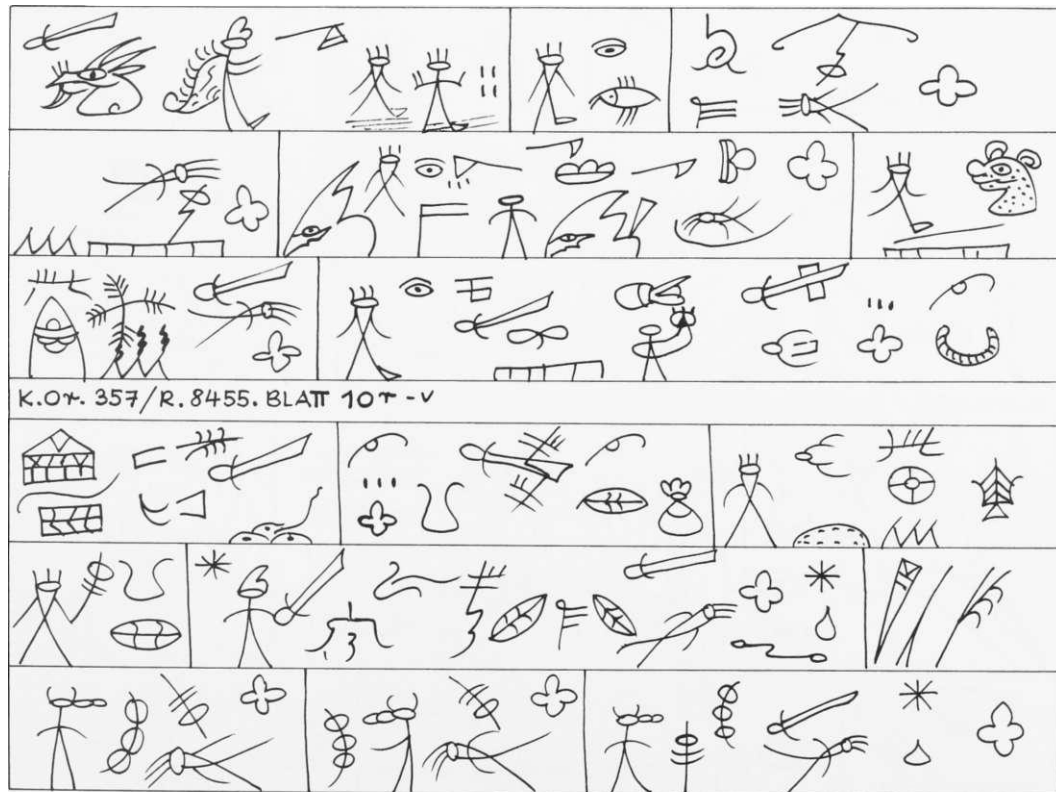
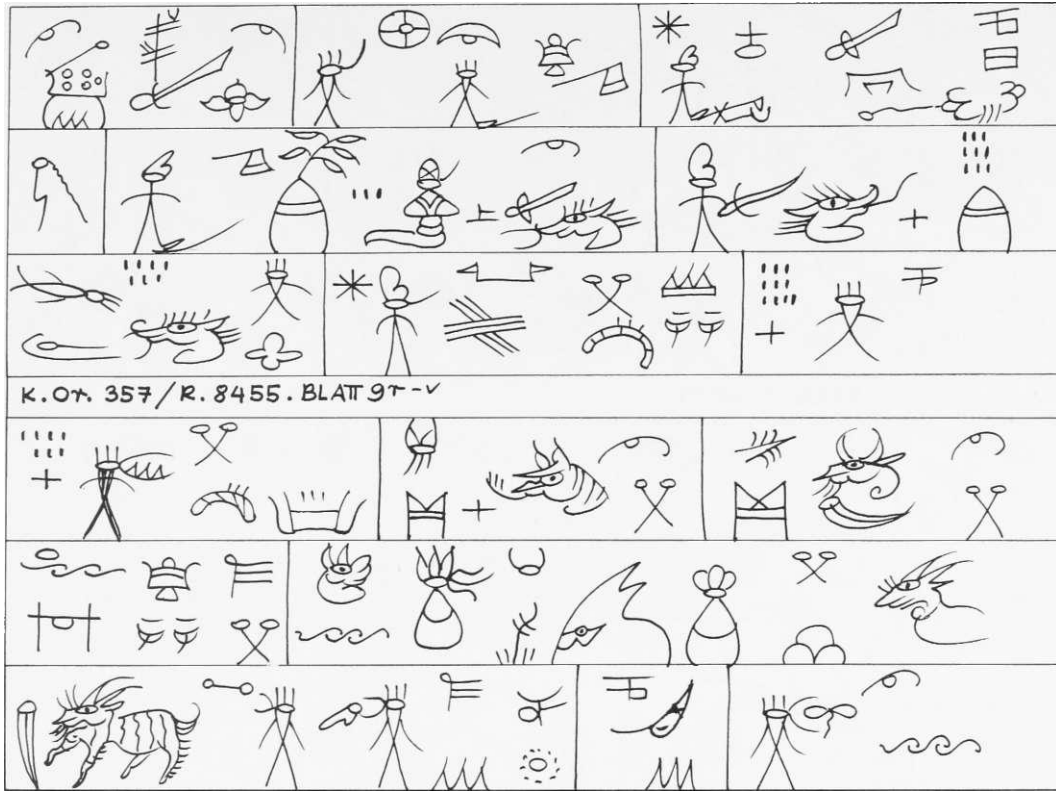

r-i-i-r-i-1		
K.O>. 35 ?/B. 5455. BLATT 11		
<i>IS</i> /f « o j j		
		i/r

====		
K.öt. 35 ?/ 16 »455. BLATT 12/*-"		
n-\ r i i		



E r a

AM



3 2r

m

fr >>j)

⋮
⋮
⋮

III



[3]

<(ay-



K. Or. 35? / K. S>455. BLATT 13^

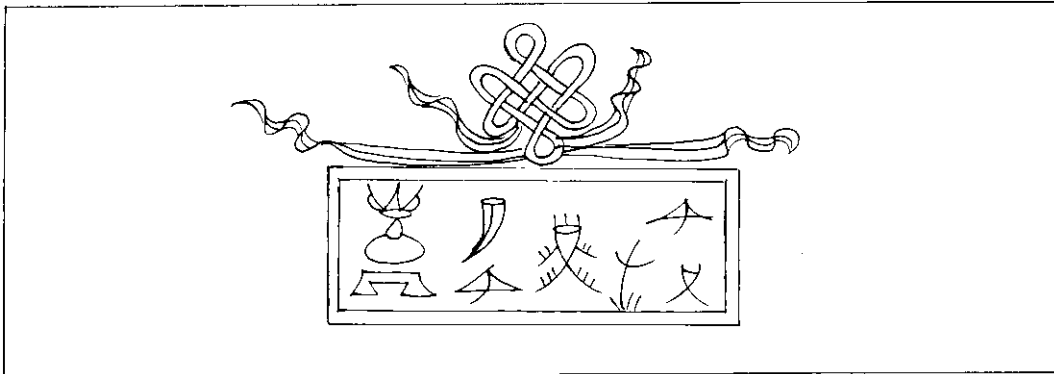

XIII, 97, n - K.Ot. 358 / R. 8456. Härt la-llu kö. Mun Ghugh bpö. BLAT 1r-v
mit XIII, 105.

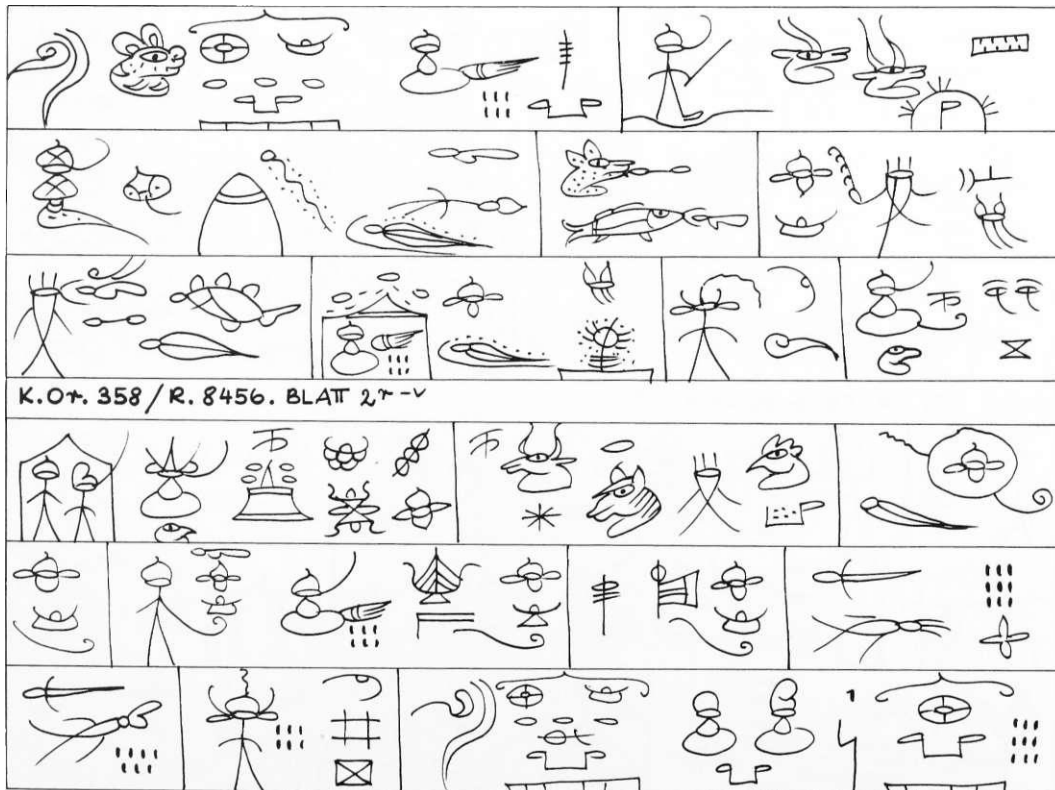
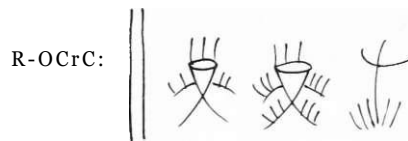

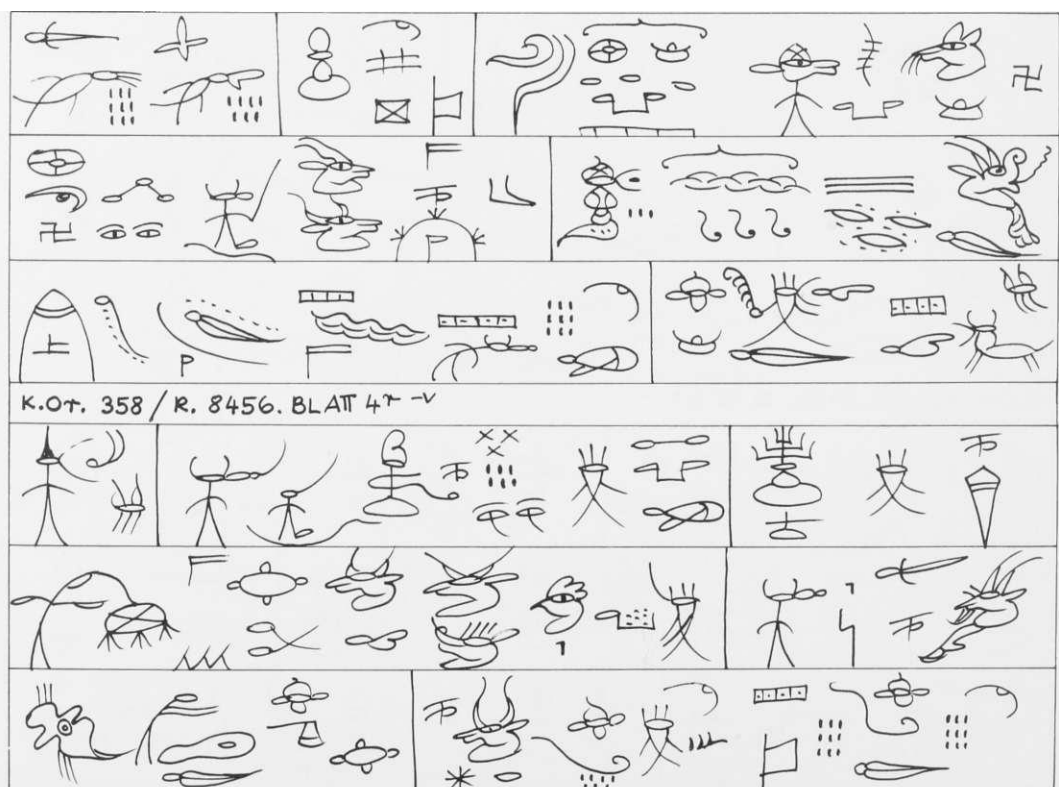
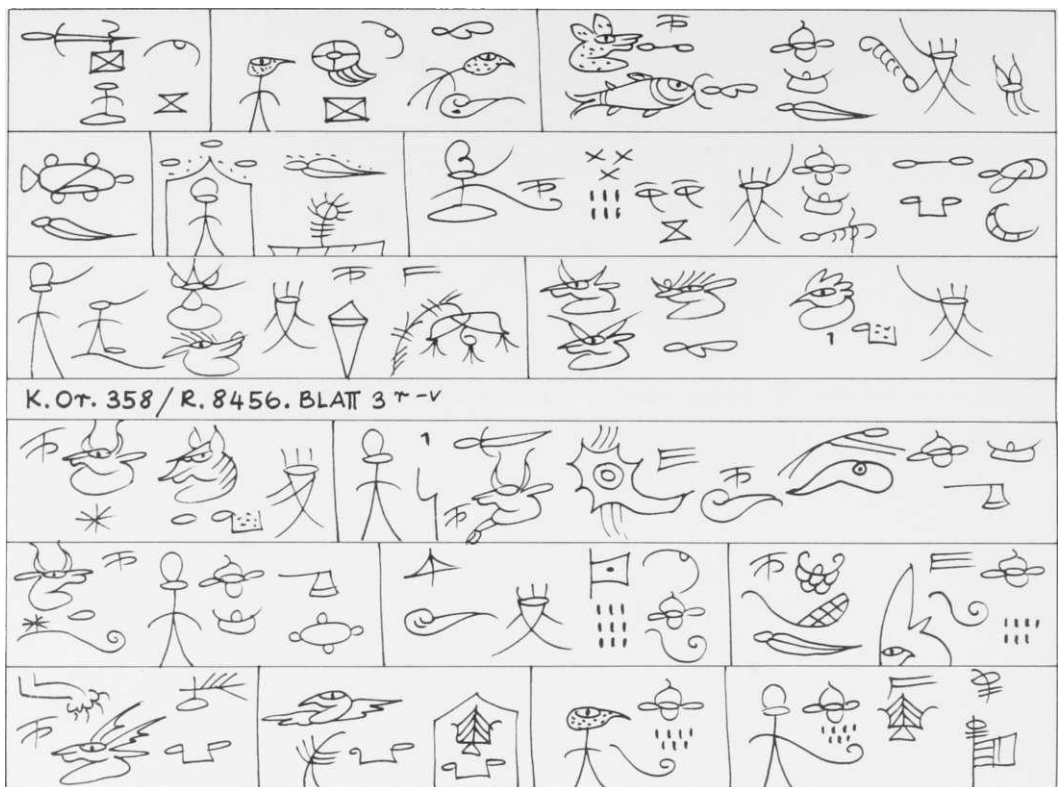

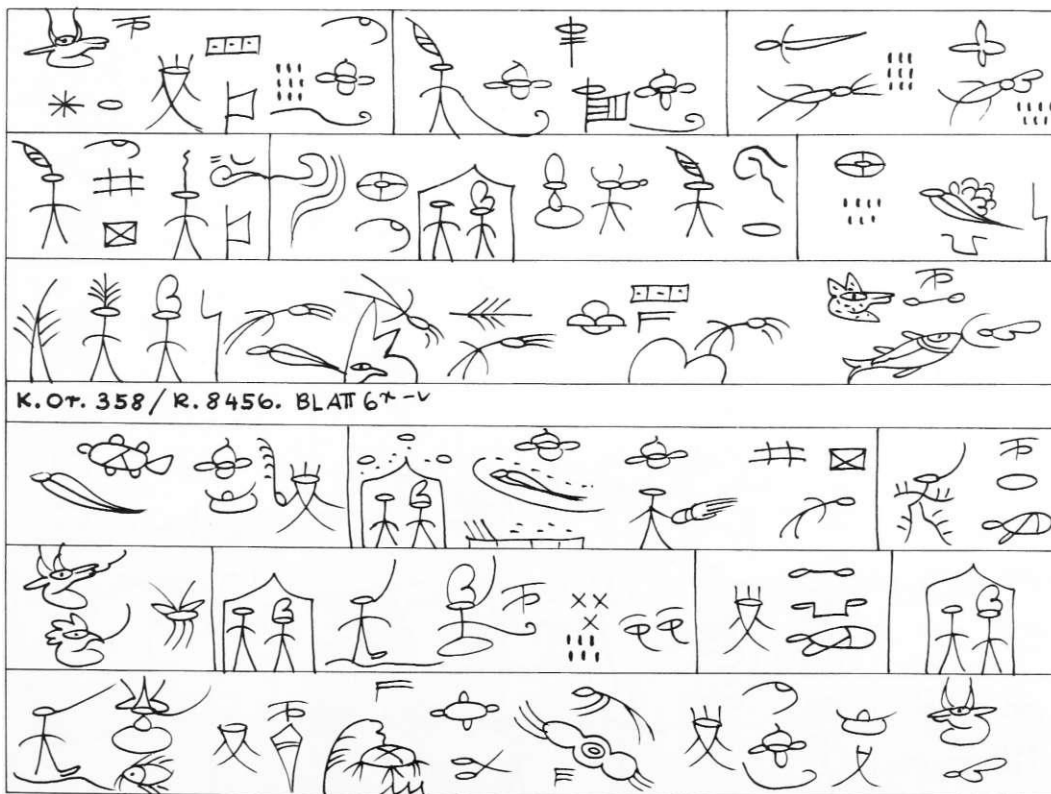
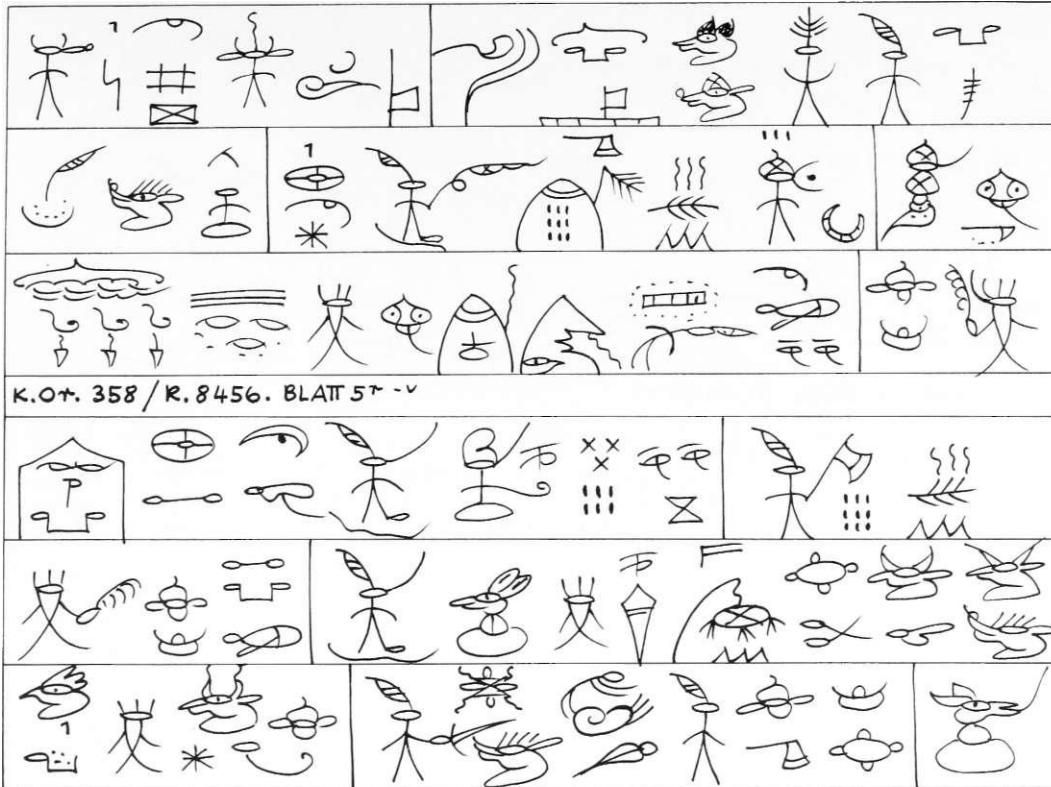

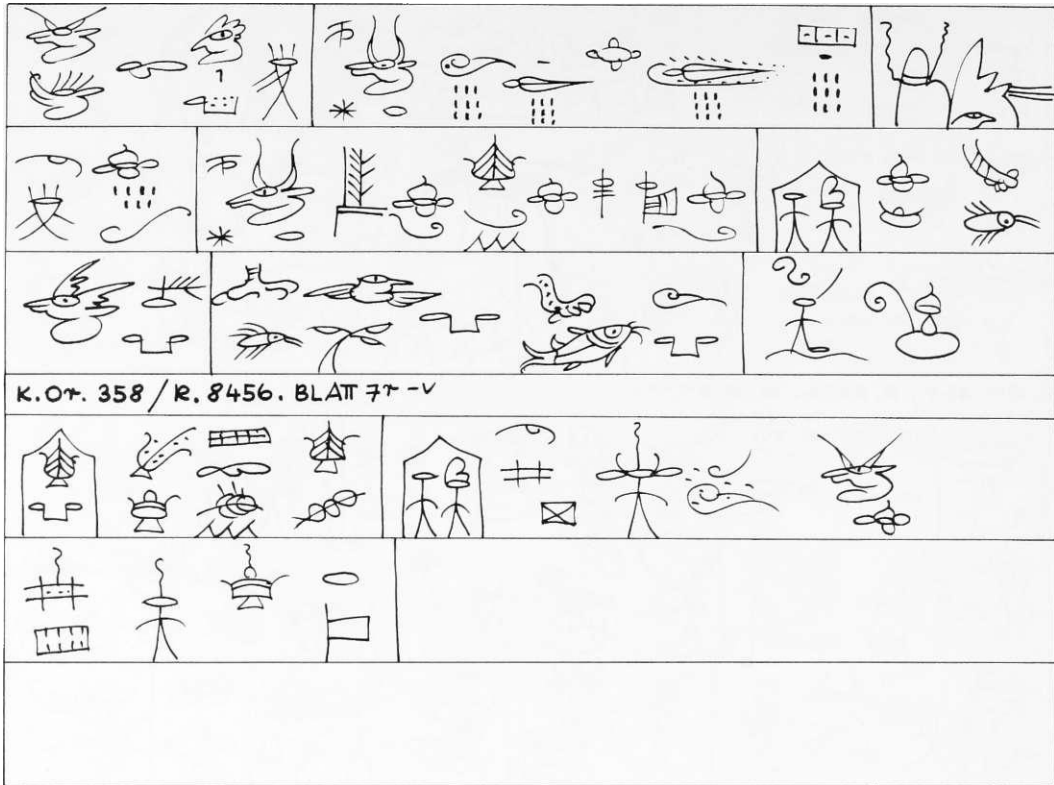

||

X



K.O-r. 355"/fe. 8HS<o. BLAW S'™ ~

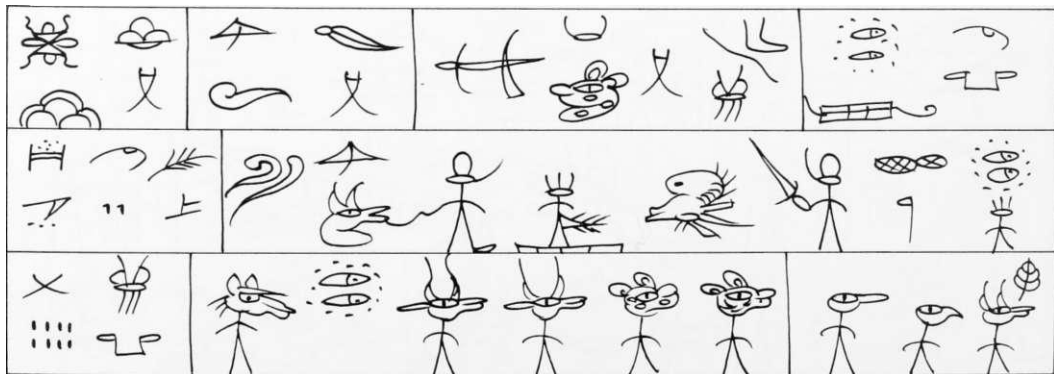

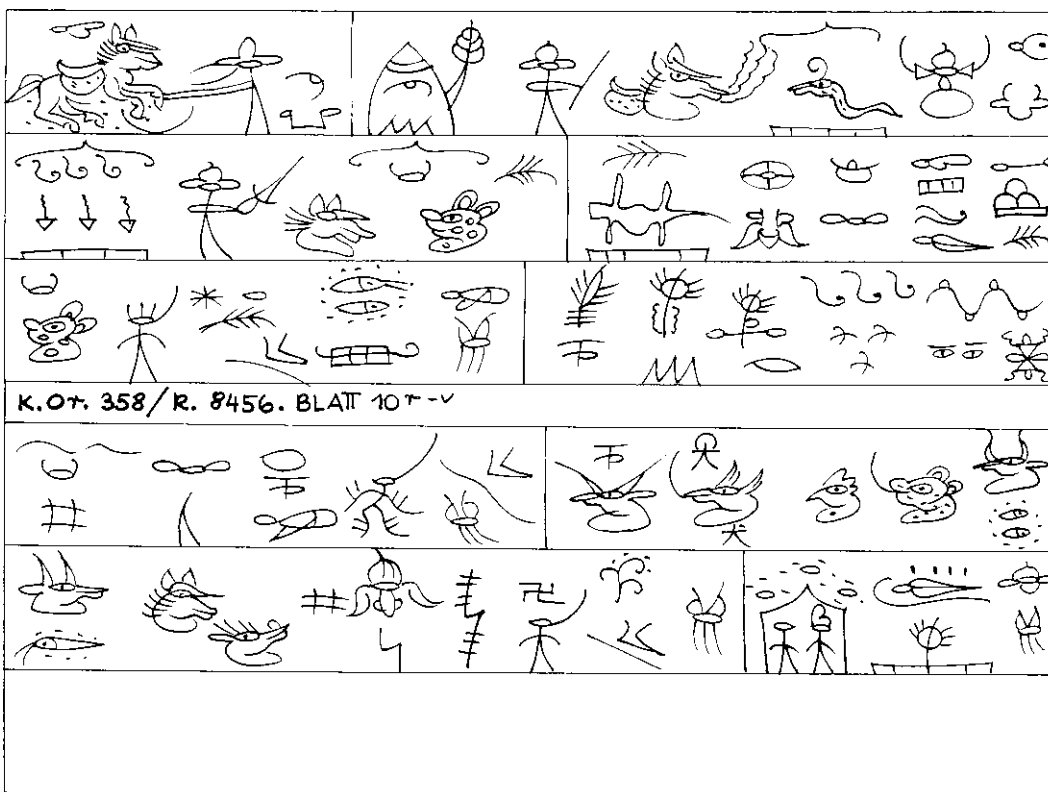
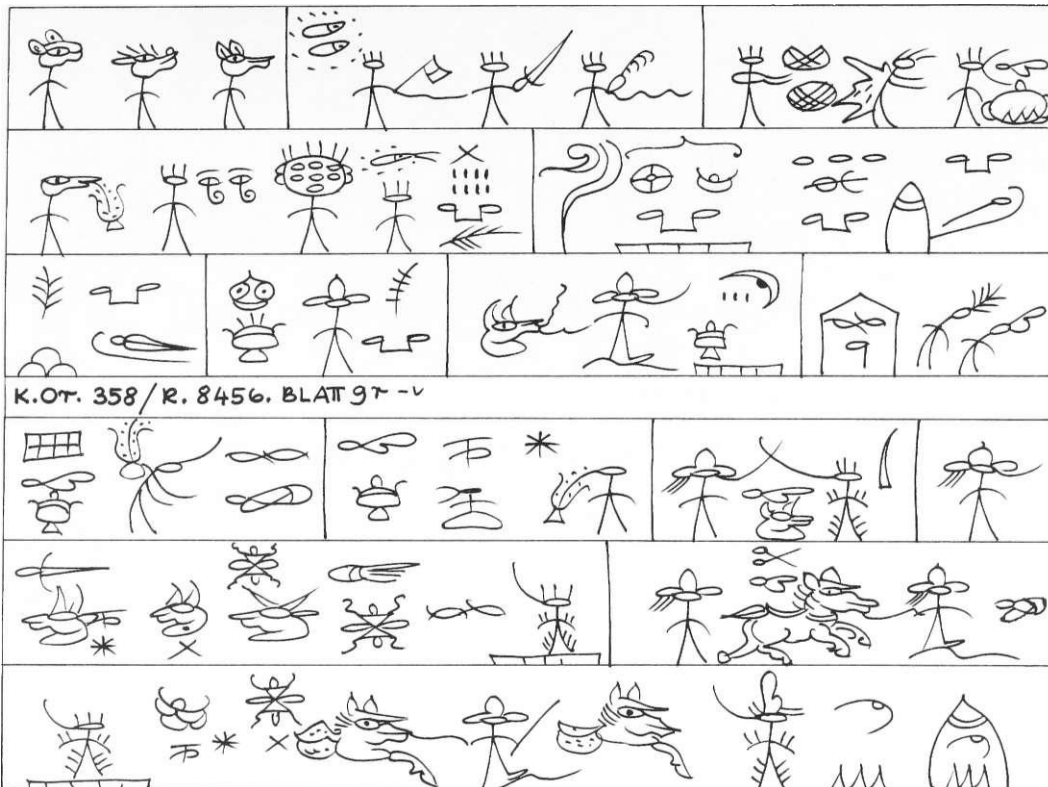

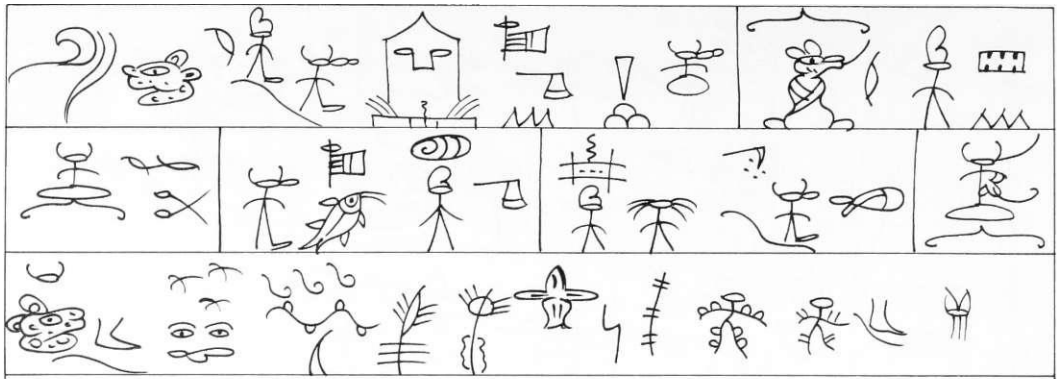

K.O7. 358/R.8456. BLATT 117-v

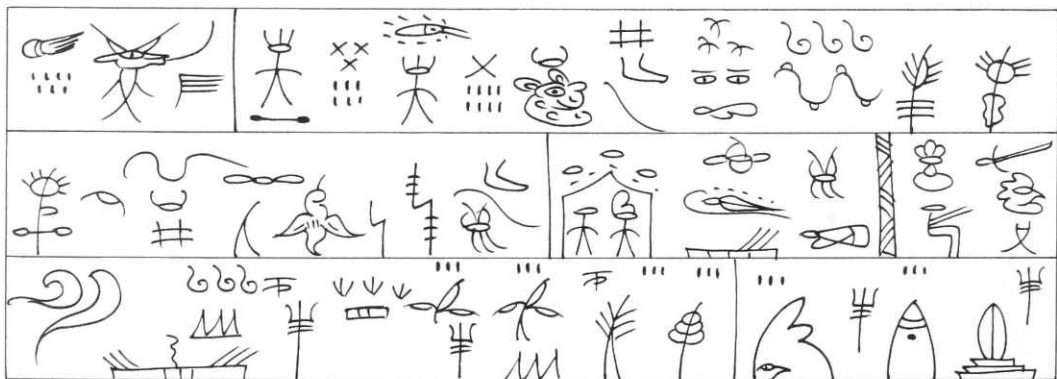
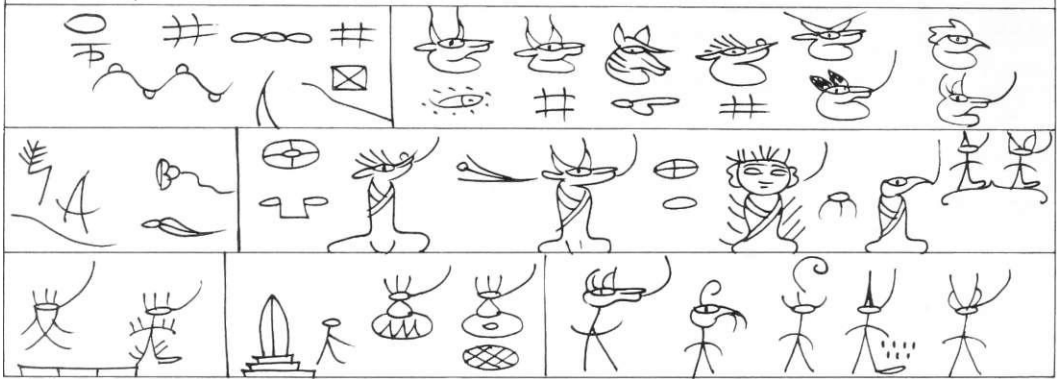

K.O7. 358/R.8456. BLATT 127-v

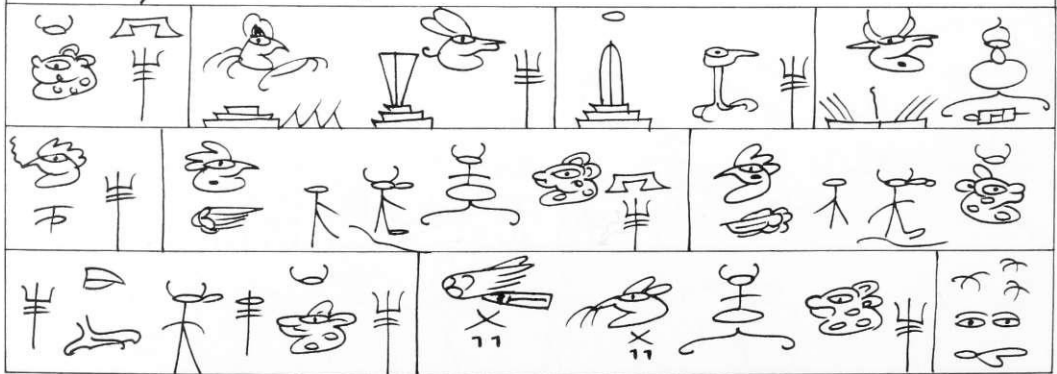

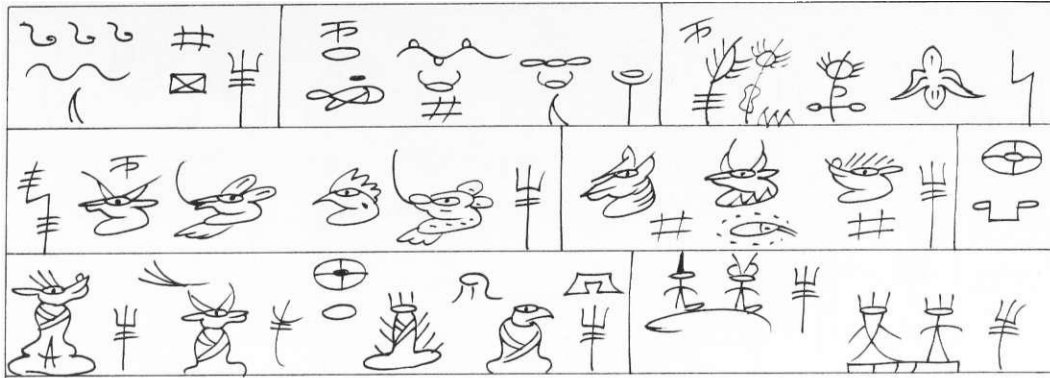

K.Ot. 358 / R. 8456. BLATT 13r-v

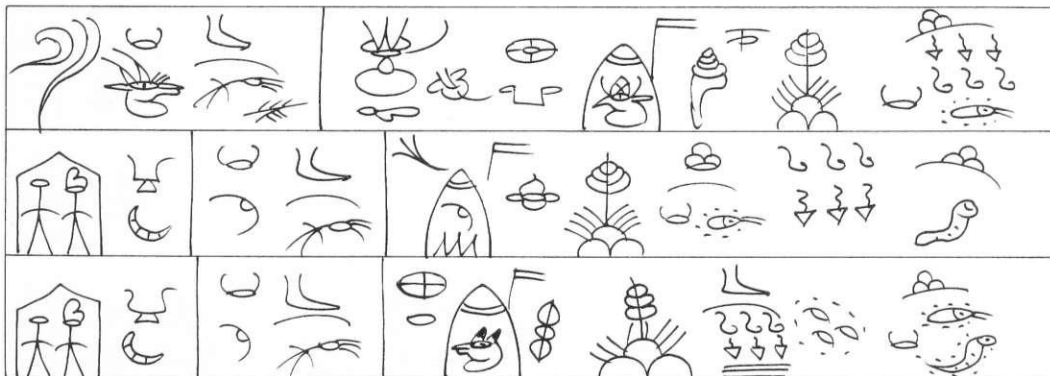
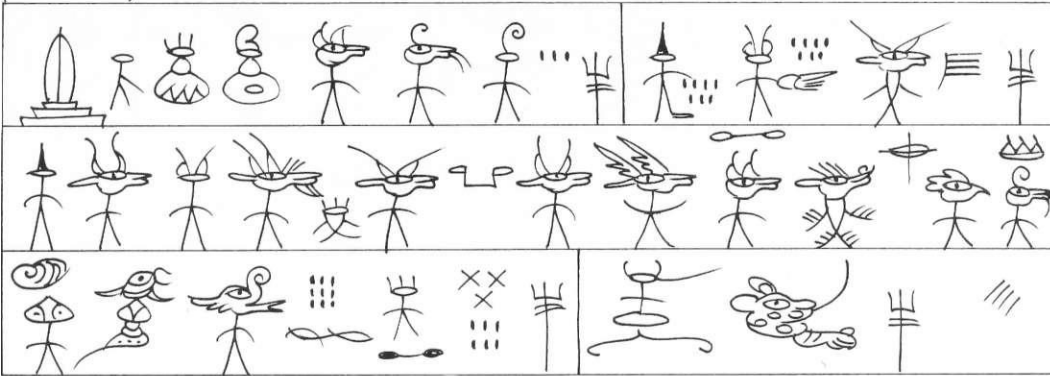

K.Ot. 358 / R. 8456. BLATT 14r-v

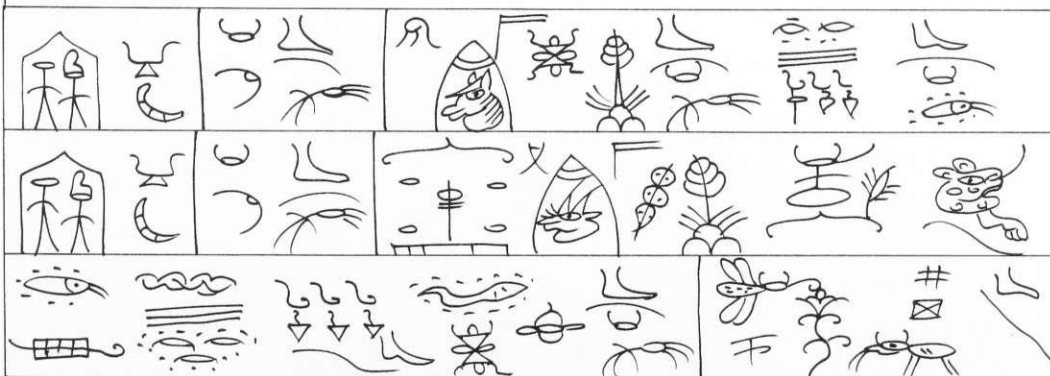

K. Or. 358 / R. 8456. BLATT 15 r - v			

TITELBLATT pBHLT

xni^{^?}^ - Hs.or.sim. s^{^?}/R.5-m. Har-la-Ud te!o. Man Qhi^{^h} bpö. BLATT 1 '-'

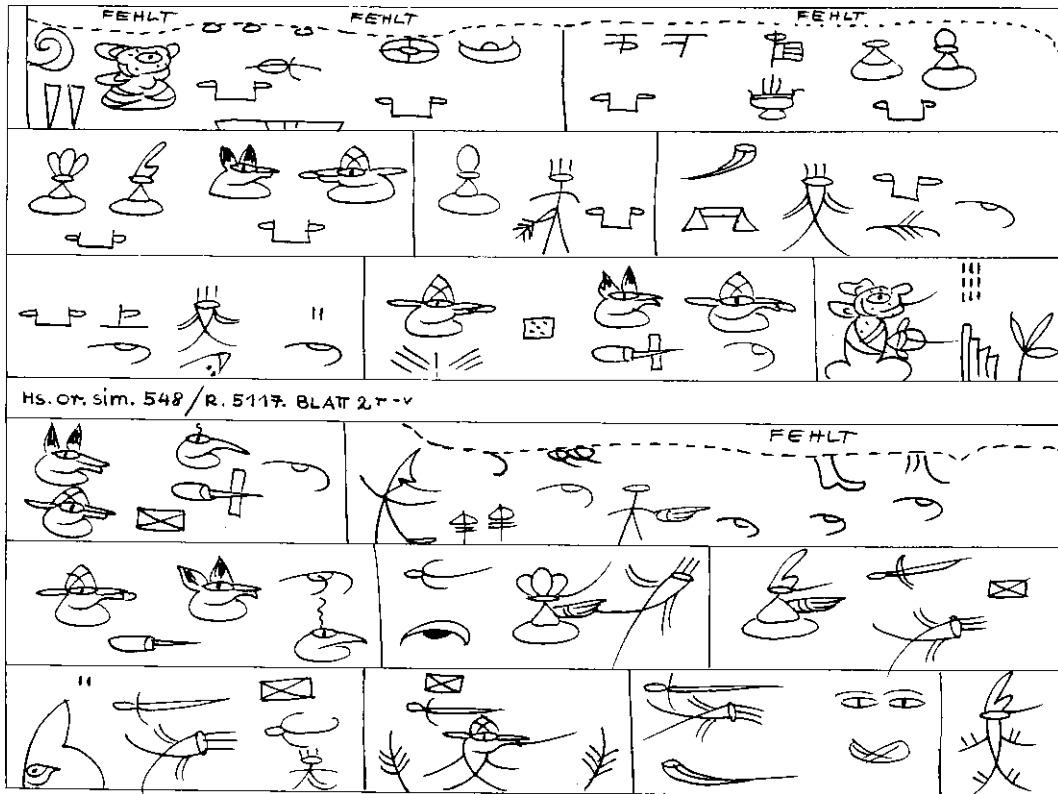
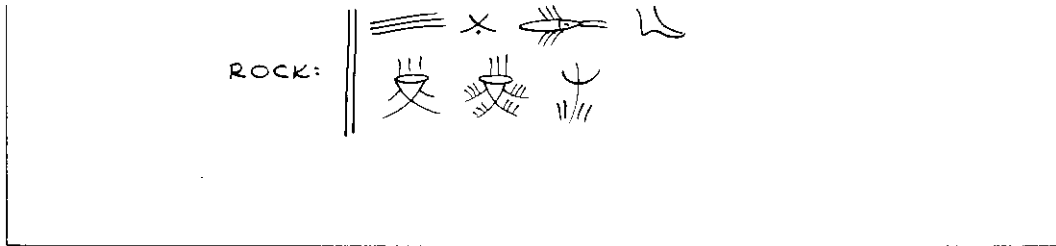

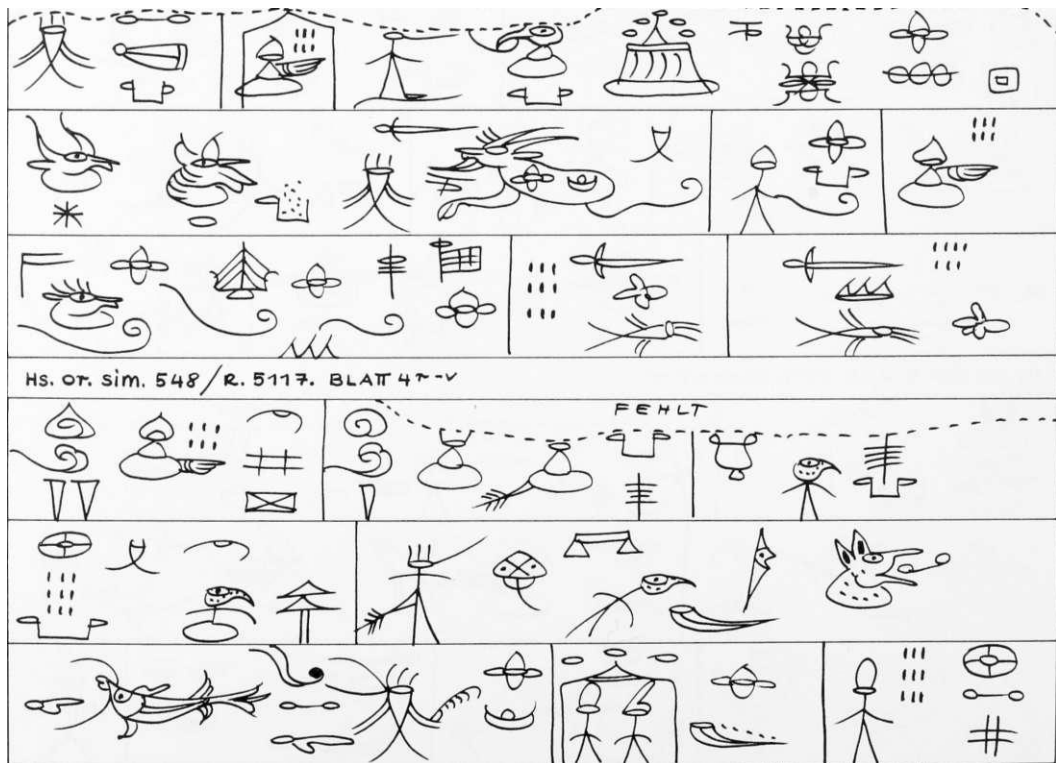
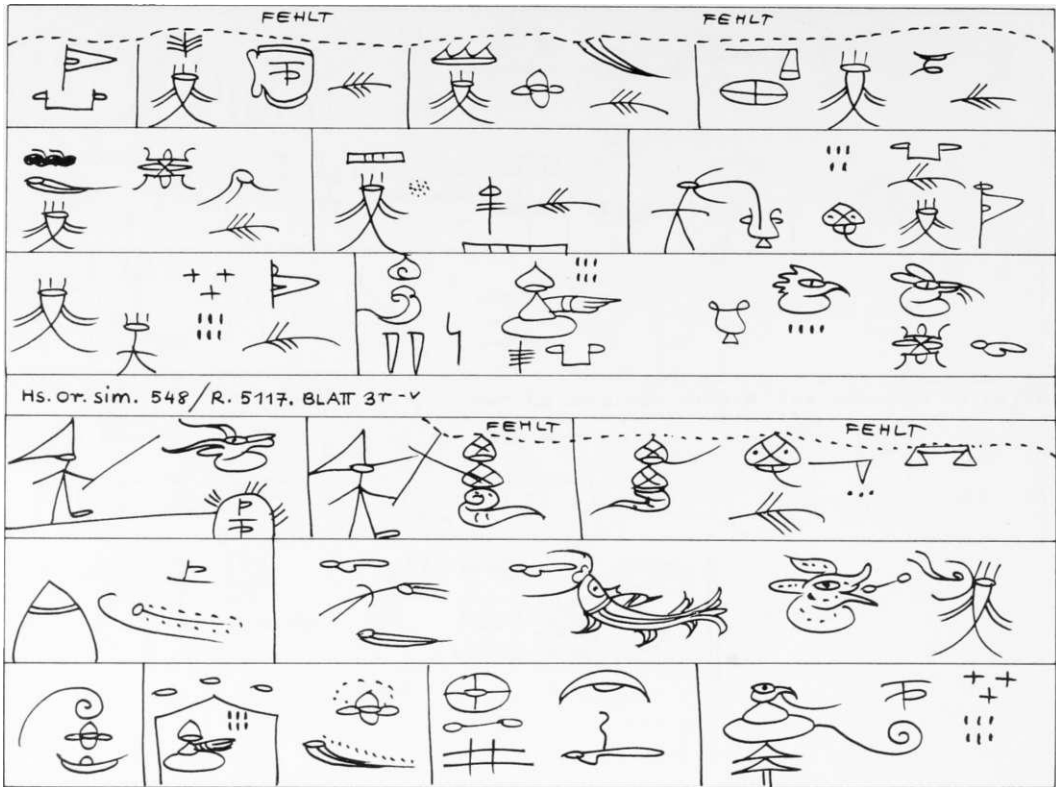

Fewer

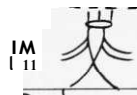

Hs. or. sim. sus/tz..

BLATT 5

1 111
i n

AAA



1 1

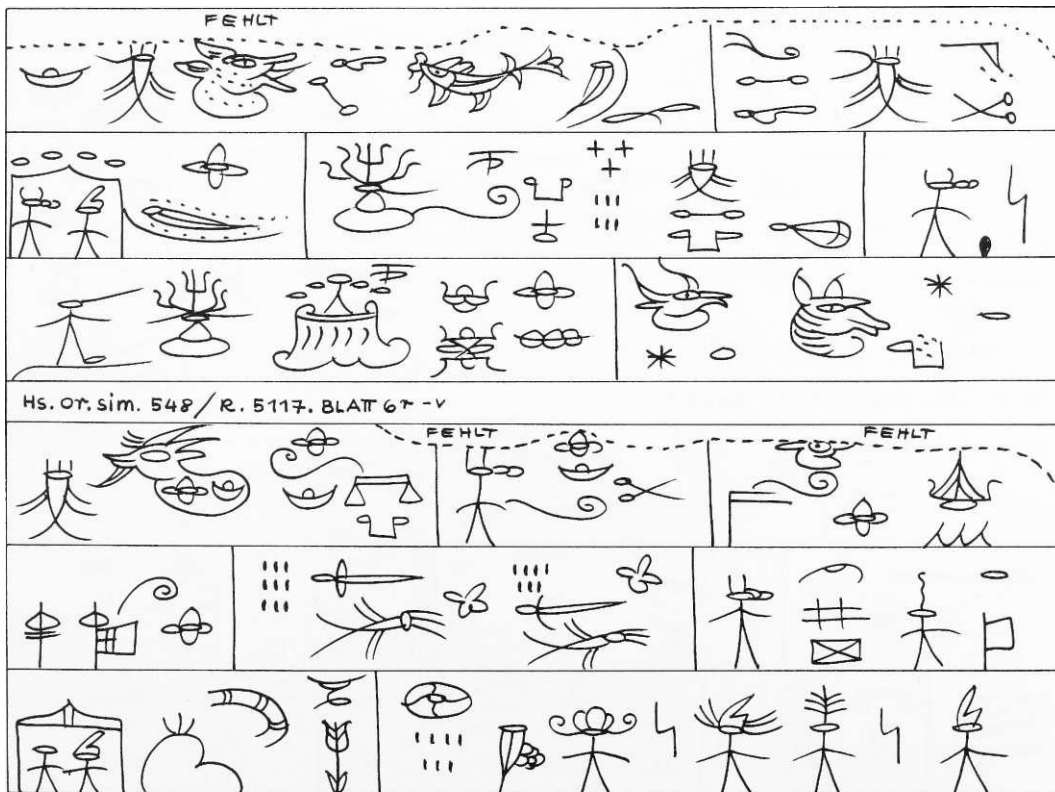
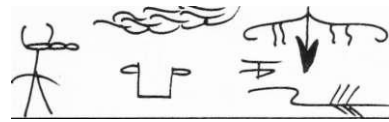

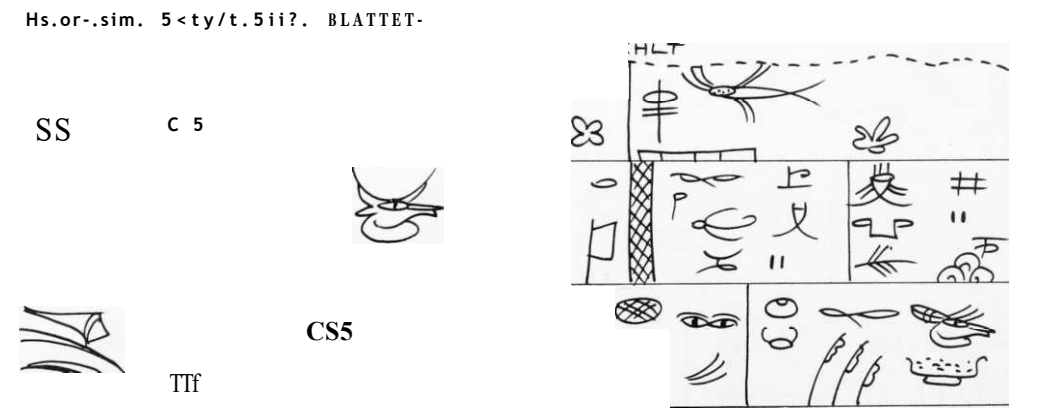
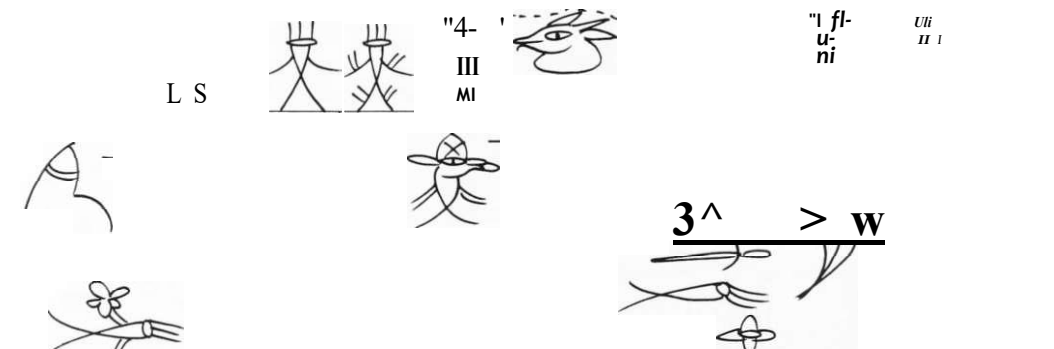
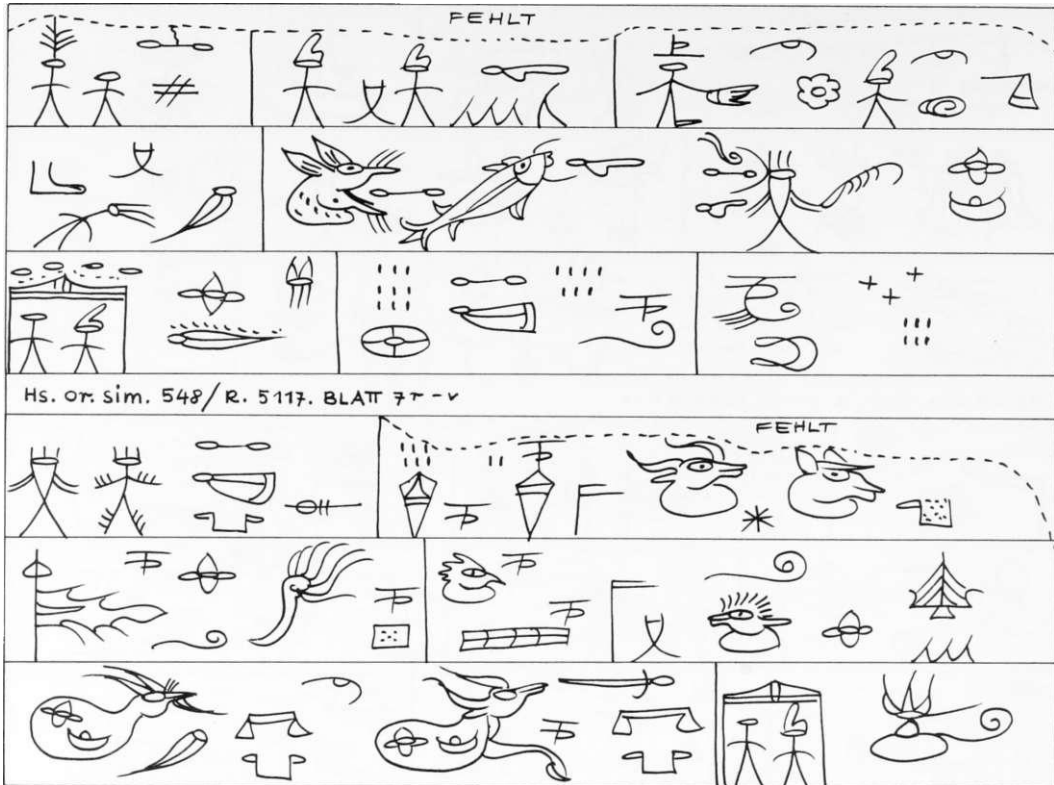

L S "4- III MI "1 fl- u: ni Uff II I



Hs. or. sim. 5 < ty / t. 5 ii ? . BLATTET -

SS C 5



TTf CS5

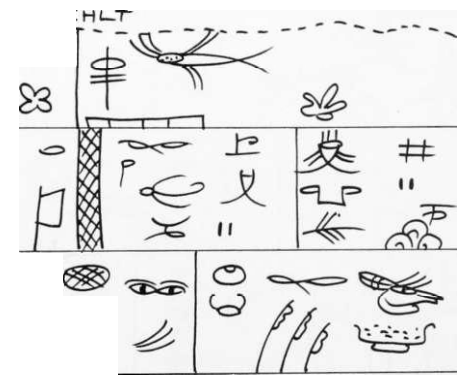



Ms. or. sim. Sk8/R. 511*. BLATT 77-V

OR-iqIMAUTITEU FEHLT

xmj 9*, o - Hs.oy. sim. Soa,/R..i-tfc.3. H&T- Co-Uw.feo. Ndu. ottü. BLATT -i^

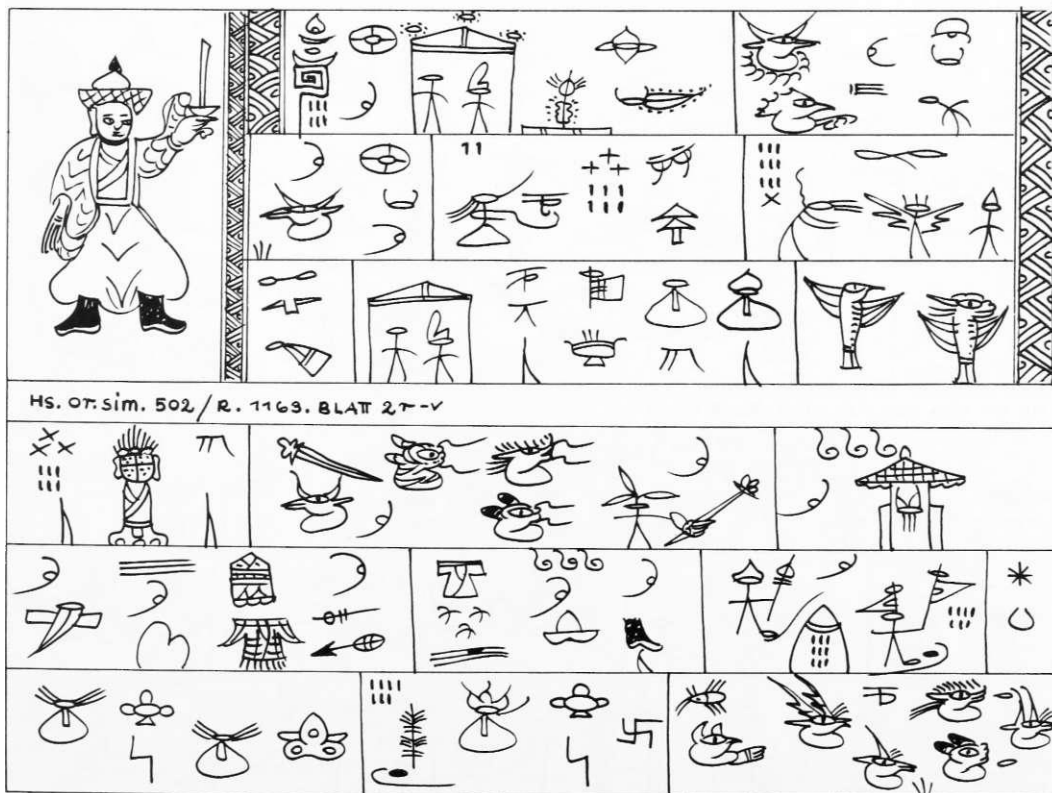
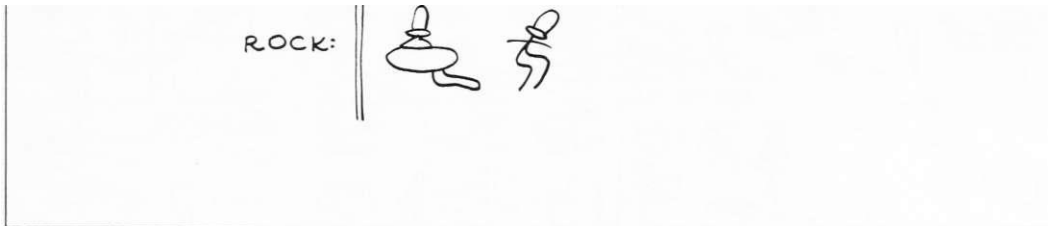

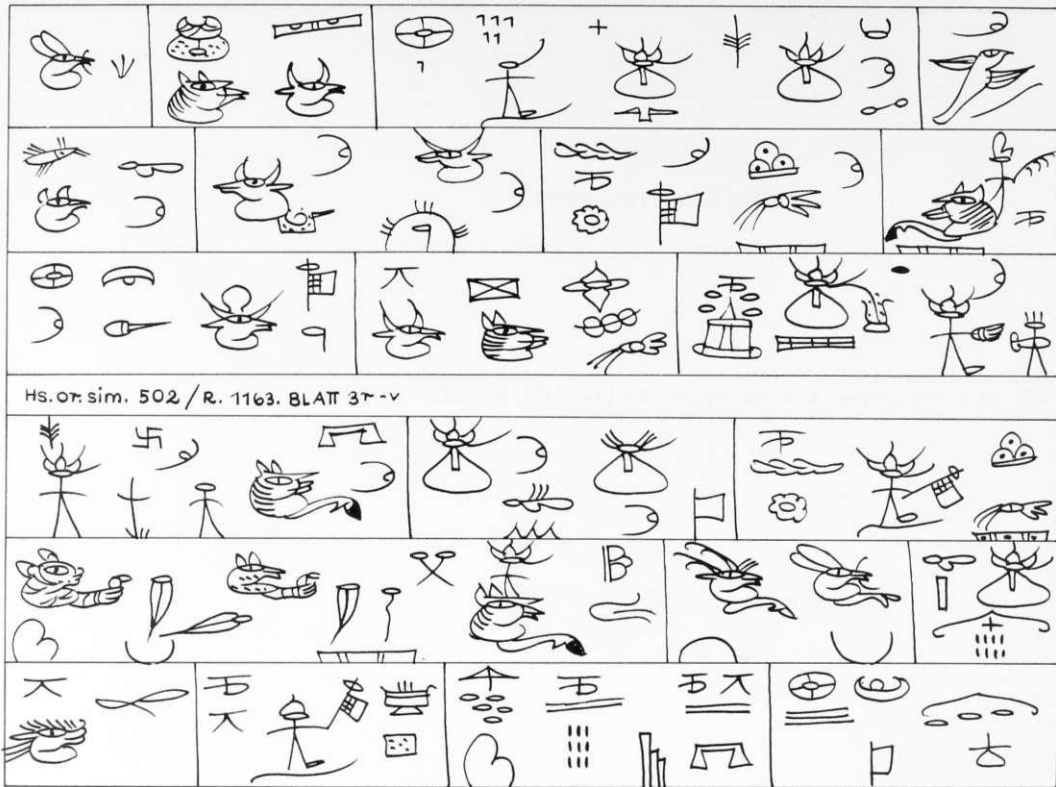

M
I
M
I



^



3

HS. or. sim. SOZ/ft.

8LAT4 ^ "



lf°¥l 1 ¥ j



L 1 1 1 1



C=5

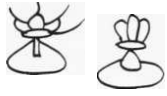

3



TV g

C7T-
" 0 "

^

r^TTT"

JT...<<



HS.OT. sim. 50a./iif03. BLATT 5

i m

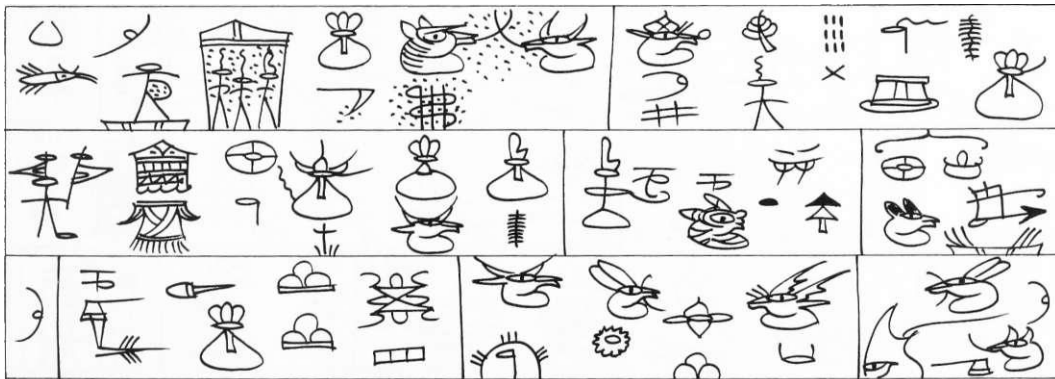
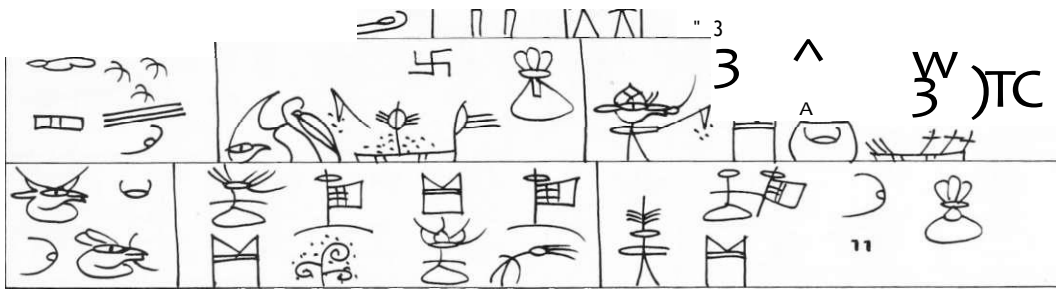

HS.OT. sim. 502/R. 1163. BLATT 67-V

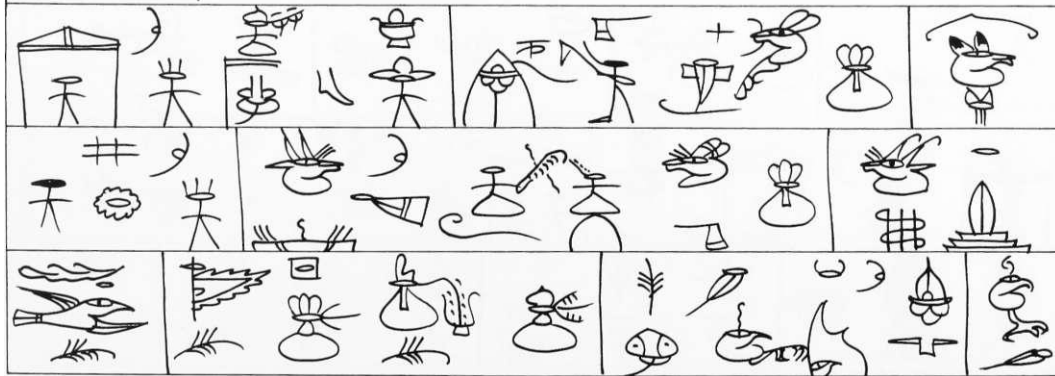

$\hat{E}C$	\hat{A}	$\hat{\wedge}$	$\ll 0 - \hat{\bullet} \# f$	$\&$
T	$\hat{\wedge}$	$!'' \leq nJ=!$	t	$ji-it /f'^{\hat{\wedge}}$
$w7$				IVA
$\bullet 51$	_____ '—' _____			$\hat{\wedge}$
Hs. or. sim. 502./R.. 1-1 fcs. BLATT ? T--V				
			$IT iL$	$''' X^a 8$

$k1$			
$\hat{\wedge} \hat{\wedge} / \hat{\wedge} \hat{\wedge} T \hat{\wedge} P l 1 l \hat{\wedge} \circ$			$li! l o$
Hs. or. sim. 502./R.. -iifc>3. BLATTST--V			
		$\hat{r}^{\hat{r}} \hat{r}^{\hat{r}}$	$p'^{\hat{f}} S$
$r *$			$\hat{\wedge} Tfel$
$1 Jt$		$S \hat{\wedge}$	$\hat{5}$
			$vr<—77-7$

XMT, 9=^0,1 - H5.0T-. sim. 5TH9/C. 5114». H dr La-LLu fe'6. Klelu. d"tu. BLATT •IT--v

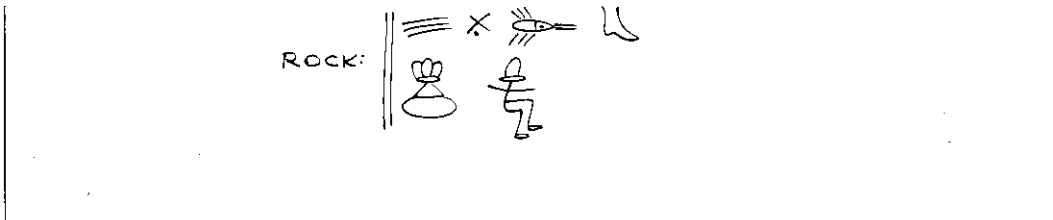

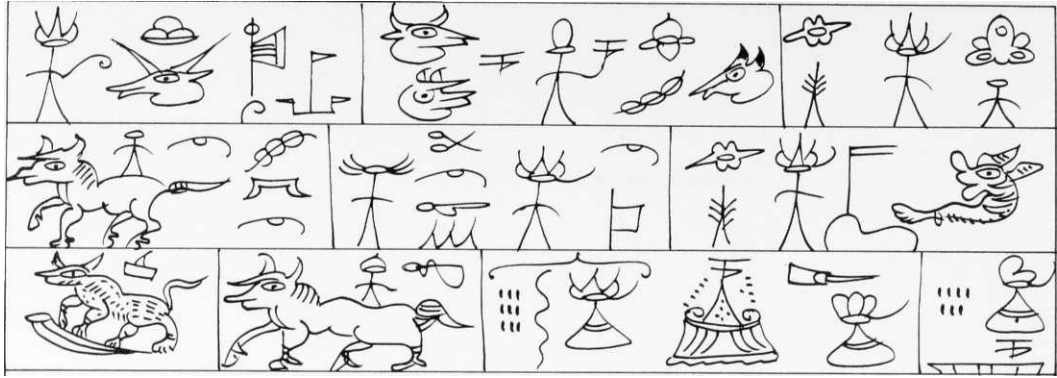

Hs. or. sim. 549/B. 5115*. BLATT Sr - v

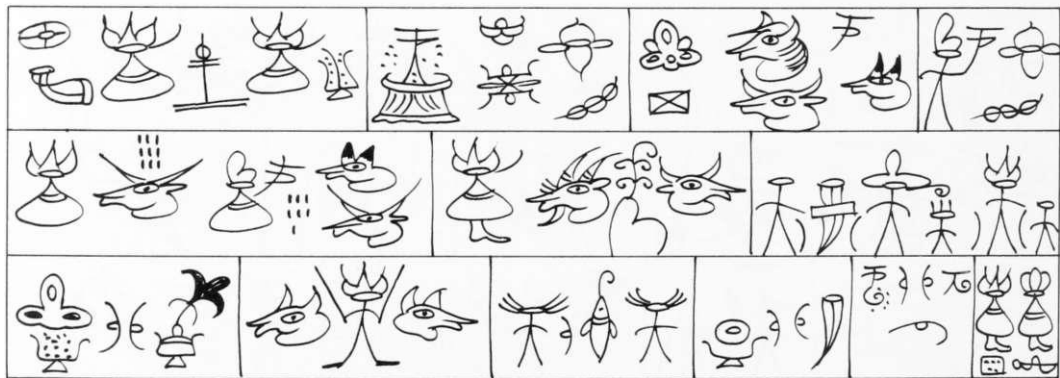
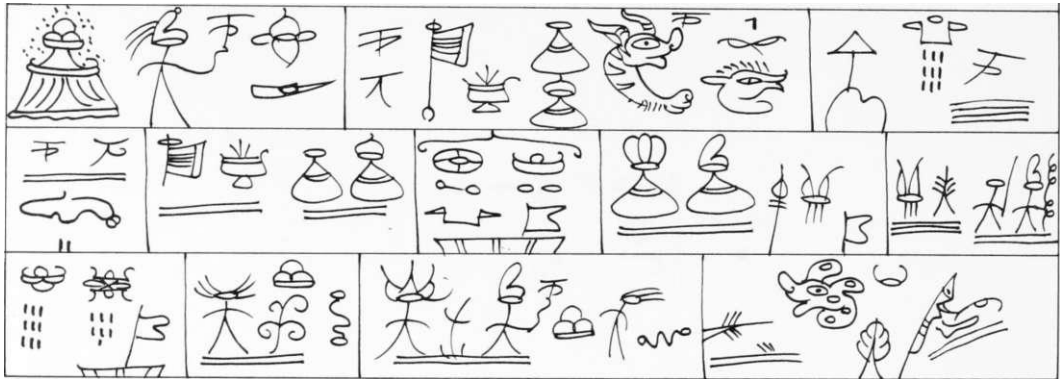

Hs.or.sim. 5H3/R,. BLATT iir-

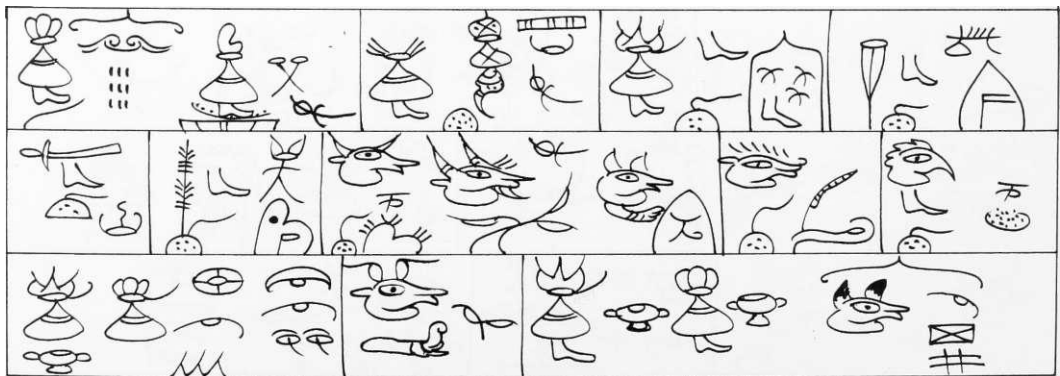

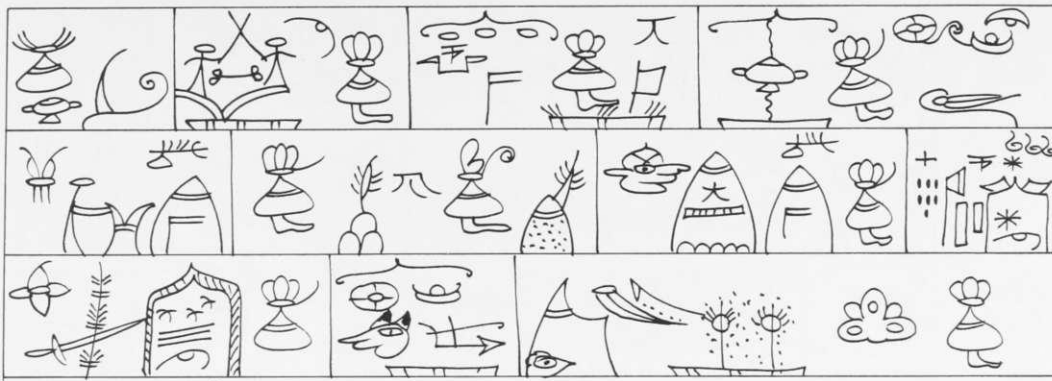

Hs. Or. sim. 549 / R. 5118. BLATT 57-V



Hs. Or. sim. 549 / R. 5118. BLATT 67-V



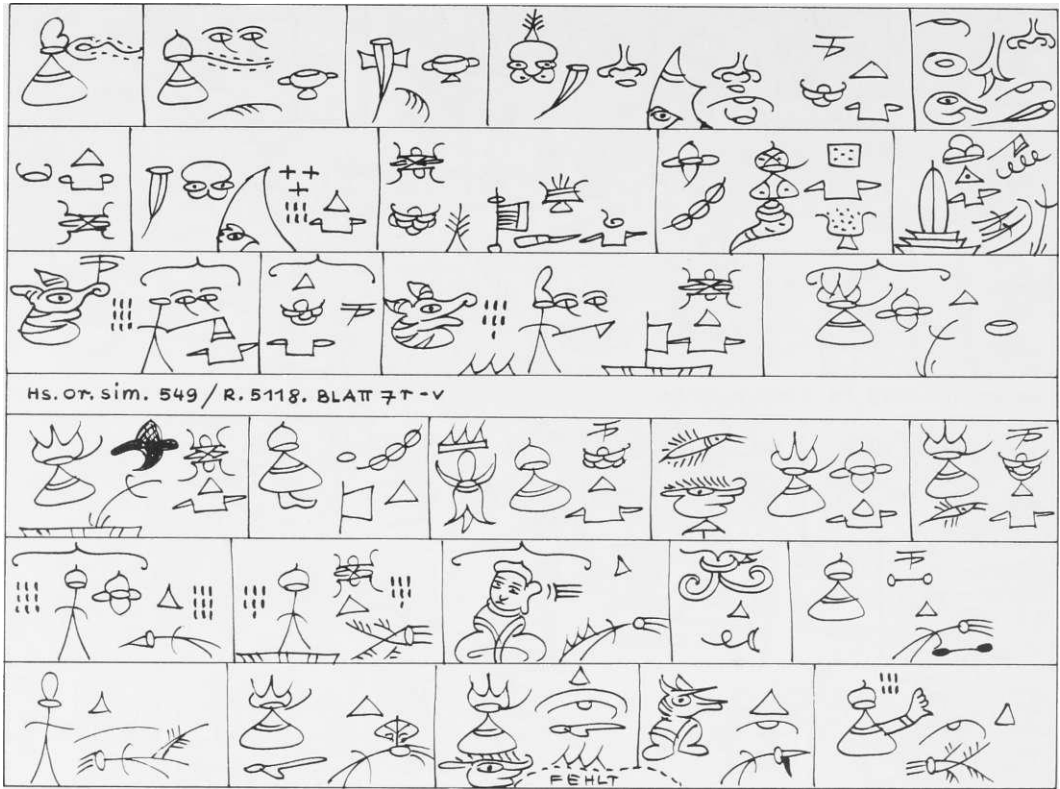

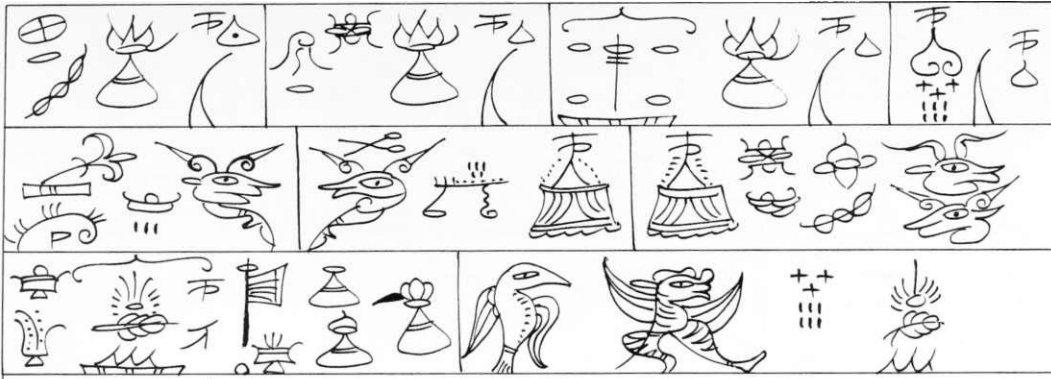

Hs. Or. sim. 549 / R. 5118. BLATT 9r-v

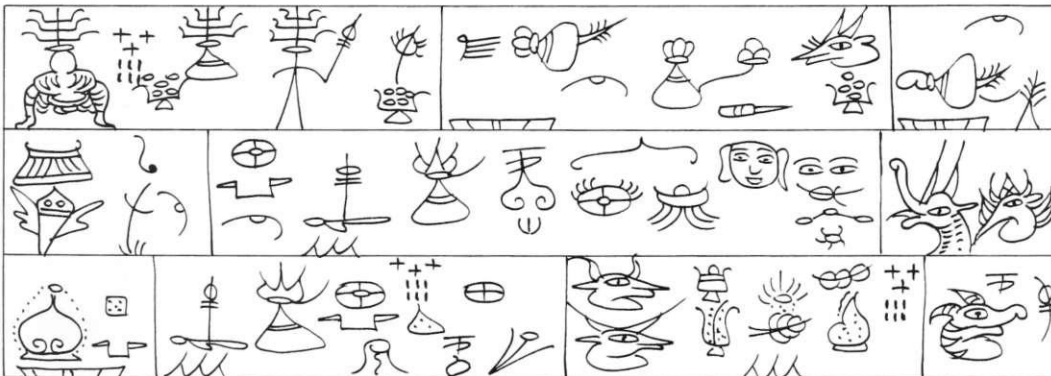
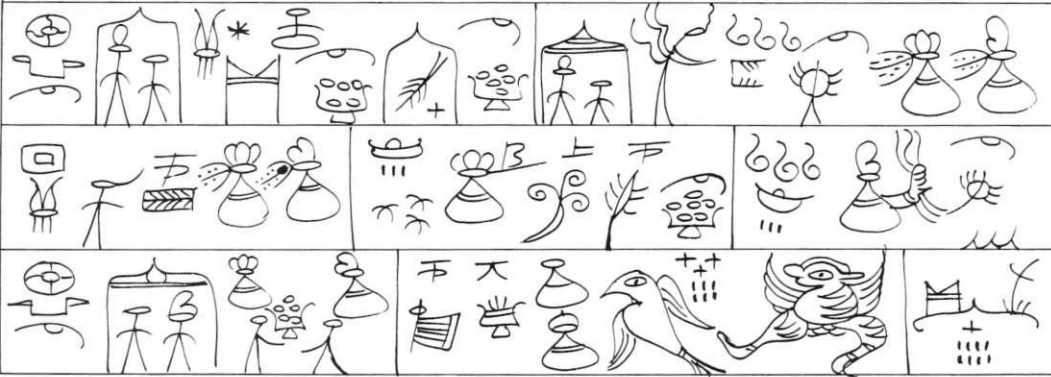

Hs. Or. sim. 549 / R. 5118. BLATT 10r-v

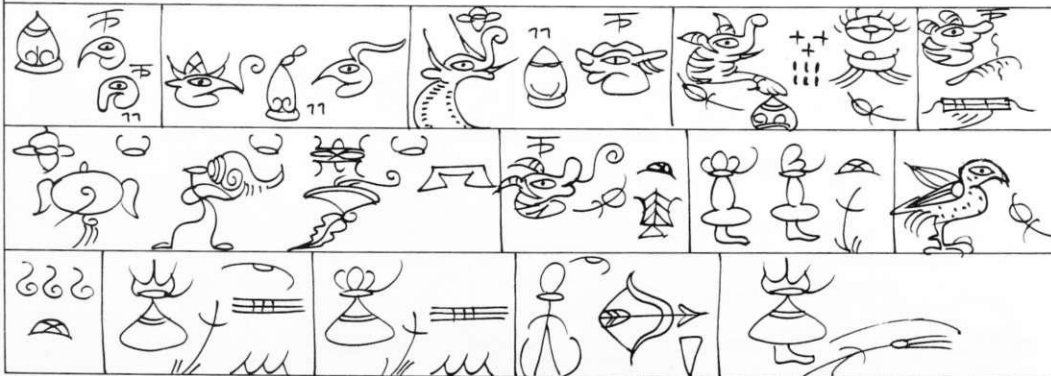

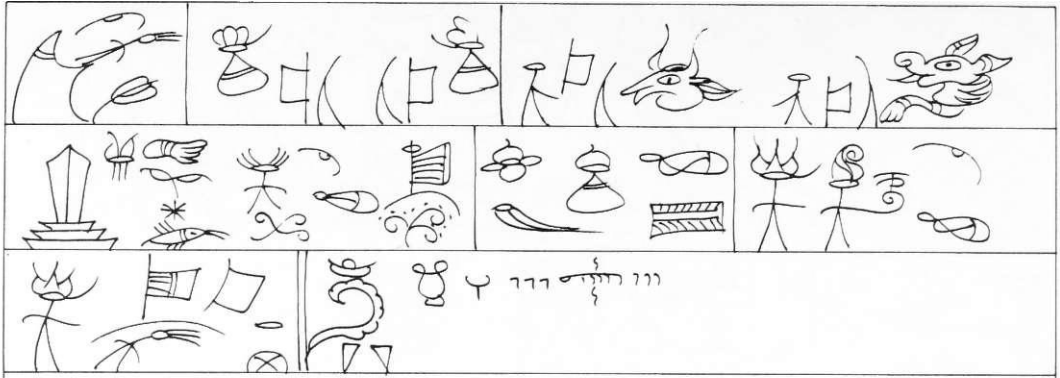

HS. OR. SIM. 549 / R. 5118. BLATT 117 - V



OR.IG,'IWALTITEL FAST VERSTÖRT

xTT; 9^0,1 - Hs.or. 3S1/R.5119. Hax ta-lulko.Nein diu. BLAT Catt)



Hs.Or. ä51/R.5119. BLATT

(c a c c)

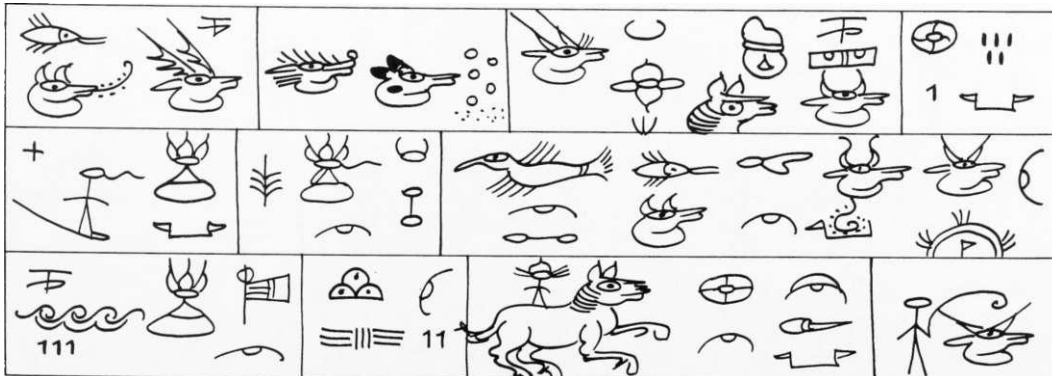

111

11

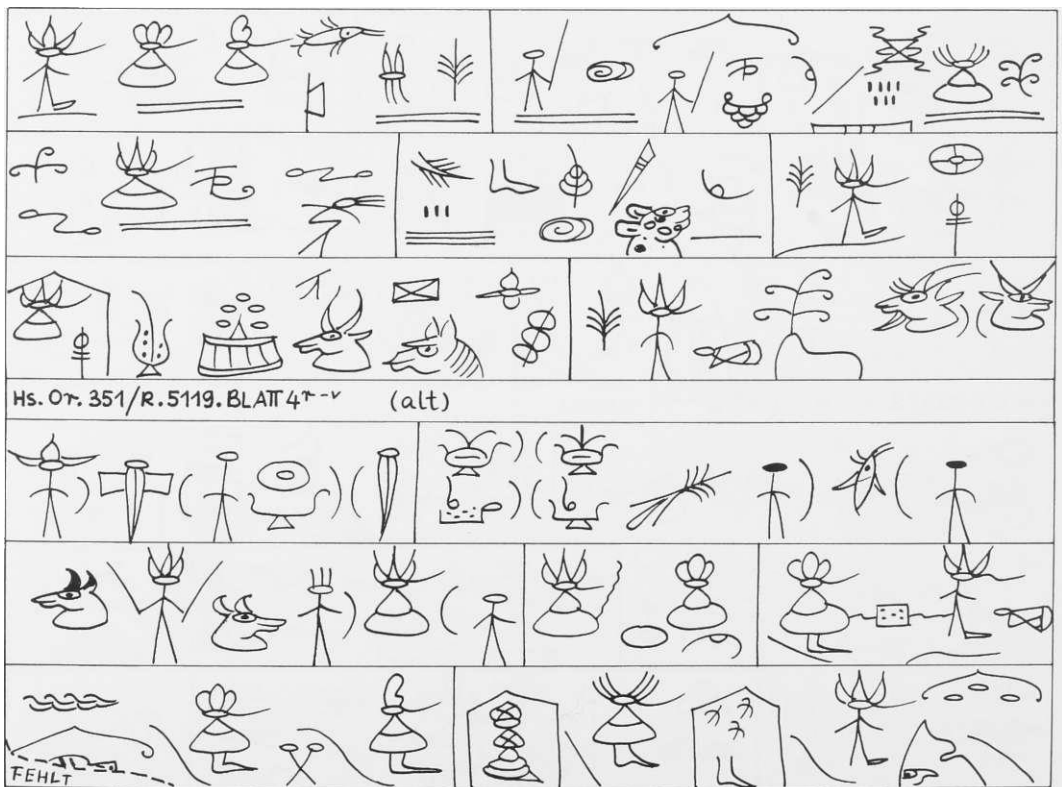
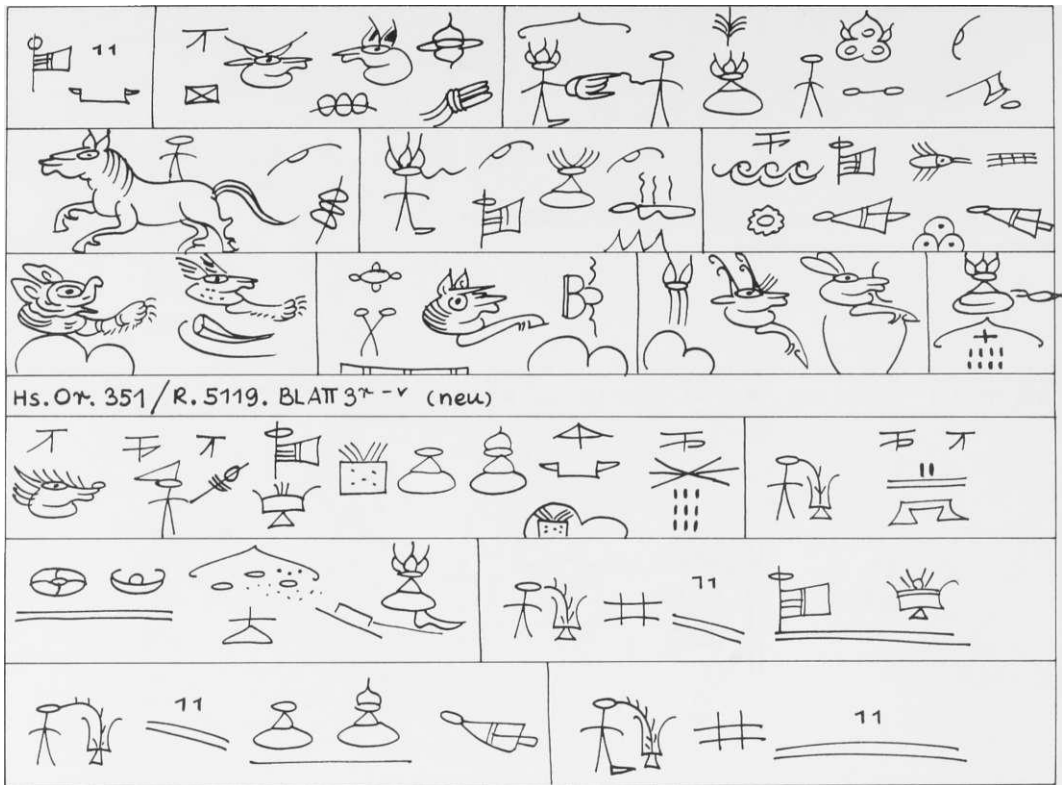

^Ag ^IL -a



M i

E I = 5°



Hs.Or. 351/R.5119.BLATT5>'" CaLt)

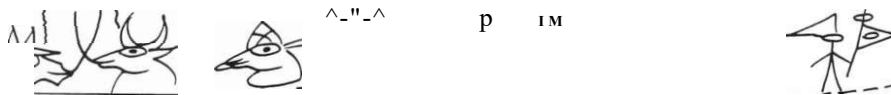
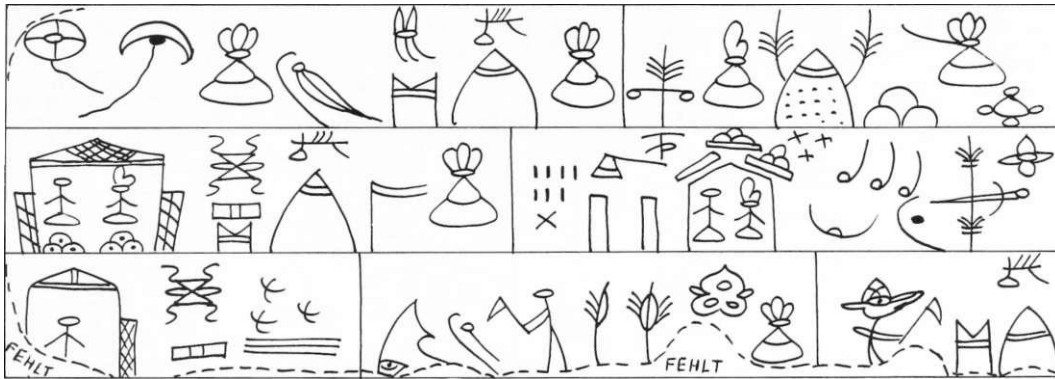

Hs.Or. 351/R. 5119. BLATTIGTM (alt)

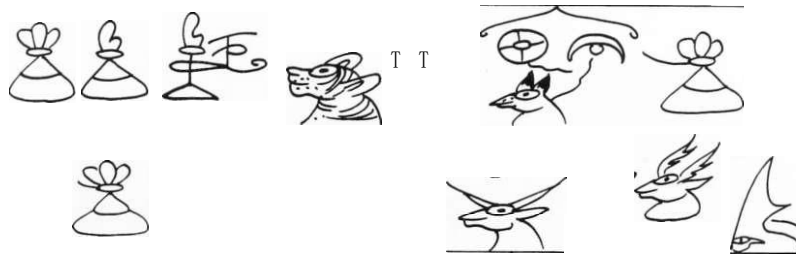

fj-ffig ^S I (fee*



HS.OT-351/B.5113. BLATT jr (. ^)

~~72~~

14

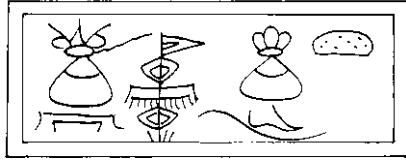

5Hir,97}0,1-Hs.Or. 352-/ R. 512,0. Hd> La-Hut k'6. Ndu. oLtü. BLATT 1 ^ -y

R-OCK:

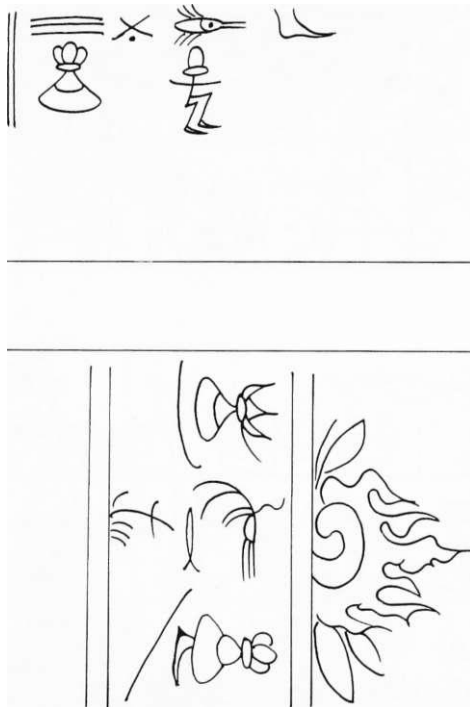

HS.OT. 352,/R. 512,0. BLATT 2, "" ""

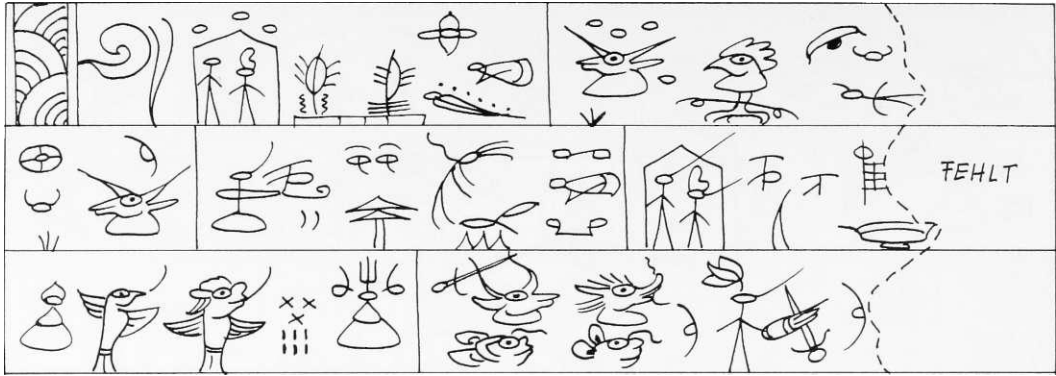

Hs. Oy. 352// B. 5A1Q. BLATT S*--^

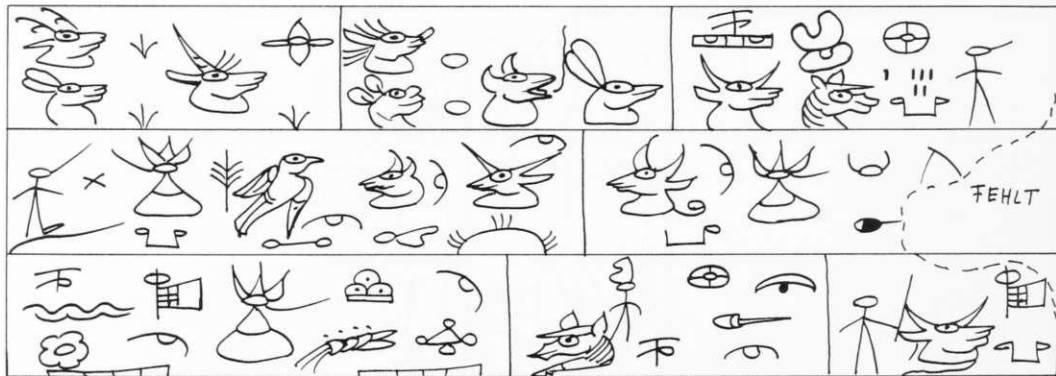
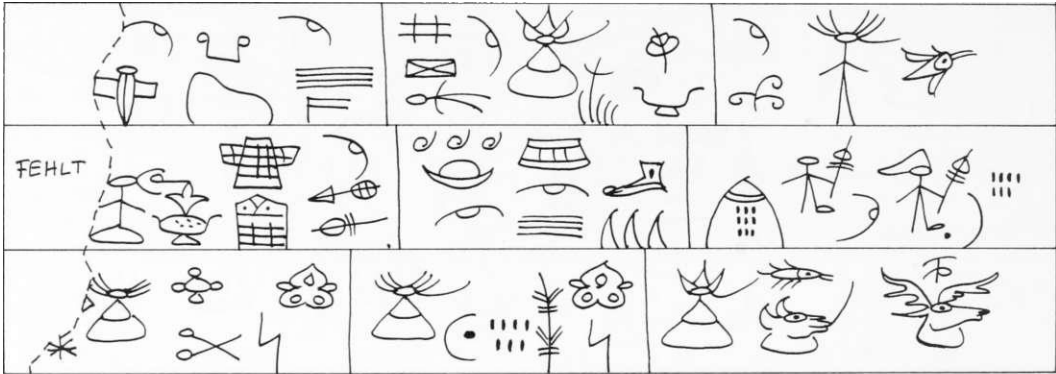

HS. Of. 352, / ft. 512,0. BLATT ^

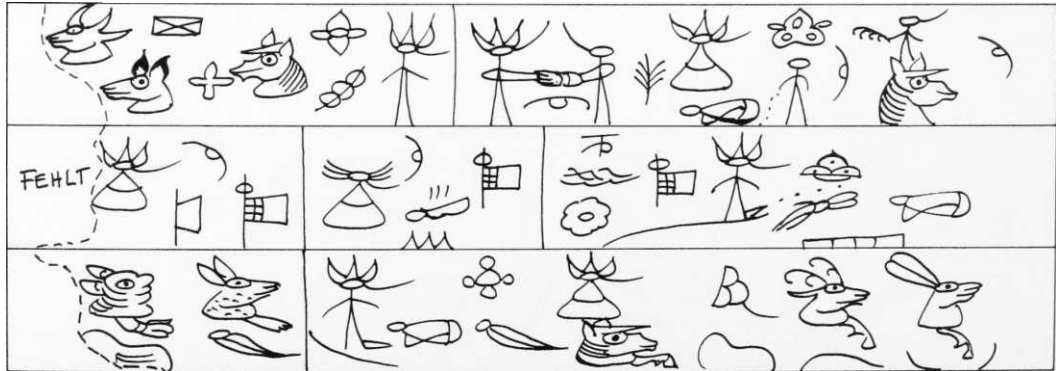

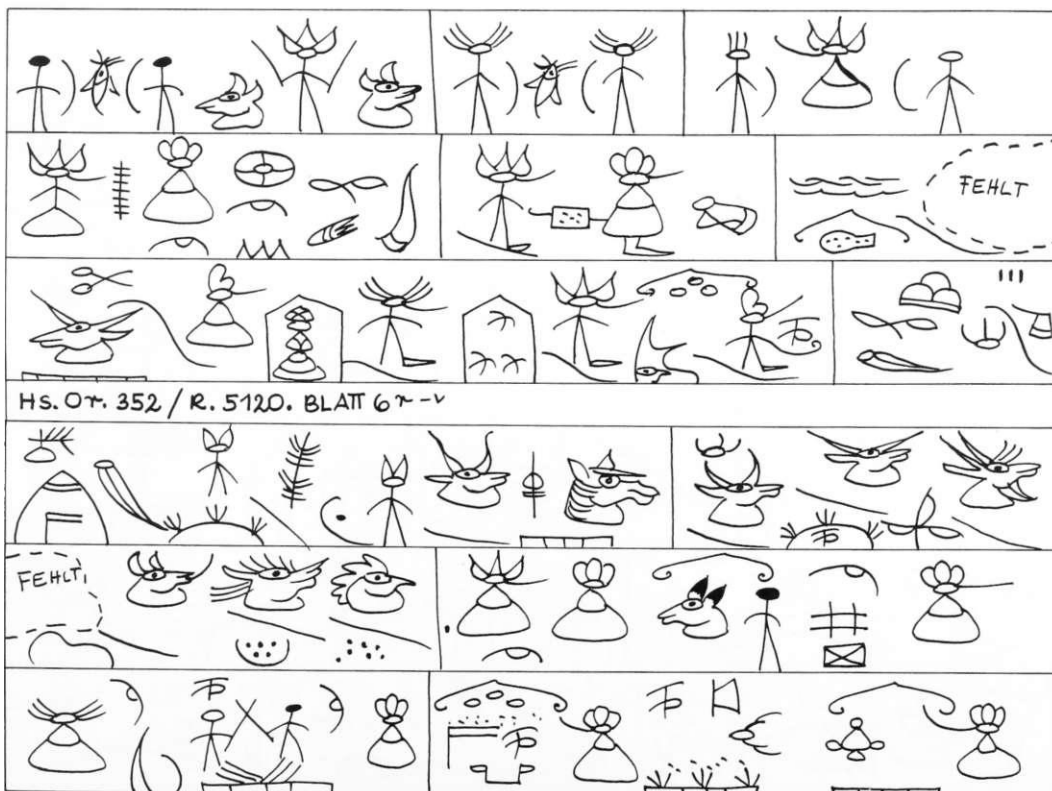
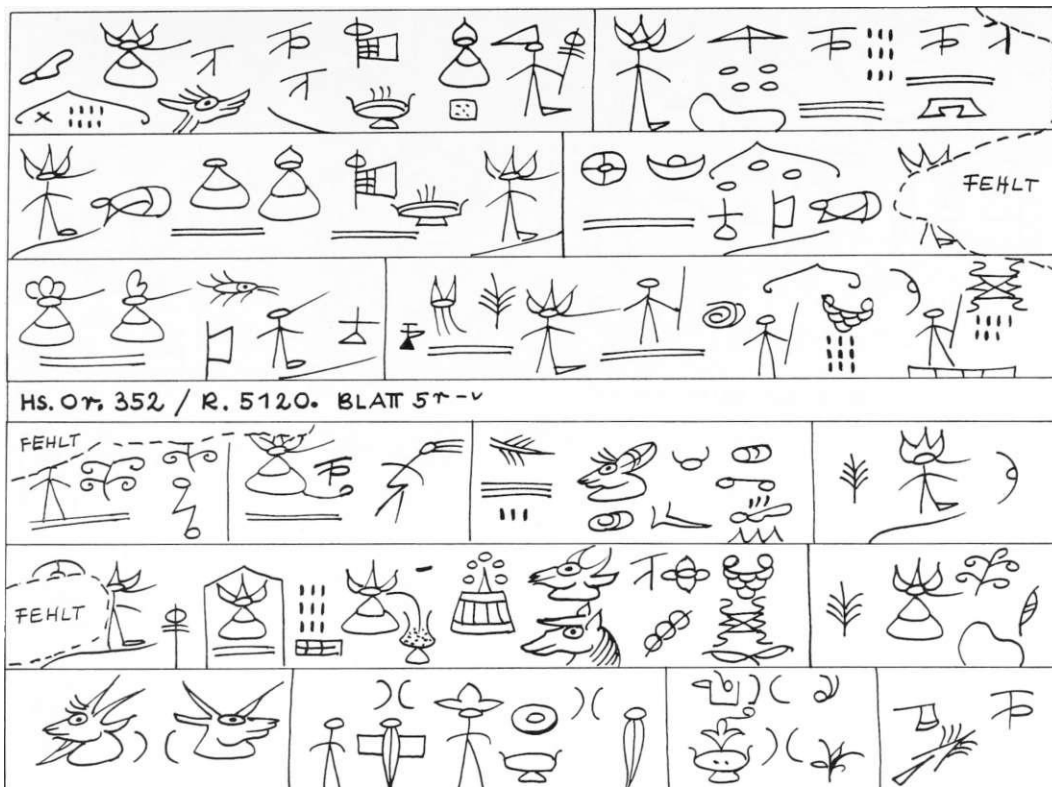

_ 2 2



LHL_

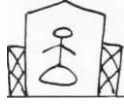

r m 0



3 A w
NM,///

Hs.O-y-, 3 5 & / 8. 512,0. BLATT



"5

FEHLT »_i

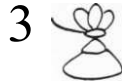

3



111

T T



in/ _____



ALii

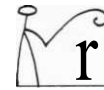

r



t u n



HS. Of-, 3 5 2 // ie. 5-12/0. BLATT J T - -'

= 6 »



9

FEHLT ;



ä 3 i

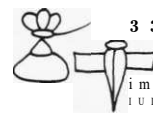

3 3

i m

i u i

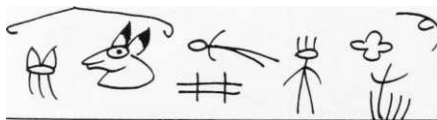

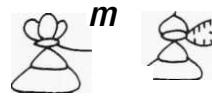

I B

^



X ^ S A A A

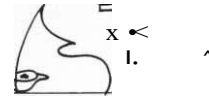

HS. OT\ 352,/ R.51Ä.O. BLATT 9** -<

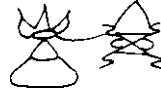

Ferteln



444



D

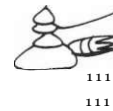

it

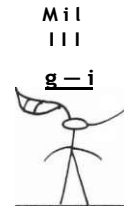
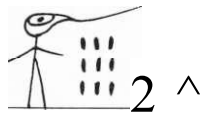

0—

Mil



Hs.OT-. 35"2,/fc. 512,0. BLATT 10r~



A

"3



A

FEHLT*

X X X
X
111



11 1



ii»



A M

0 0

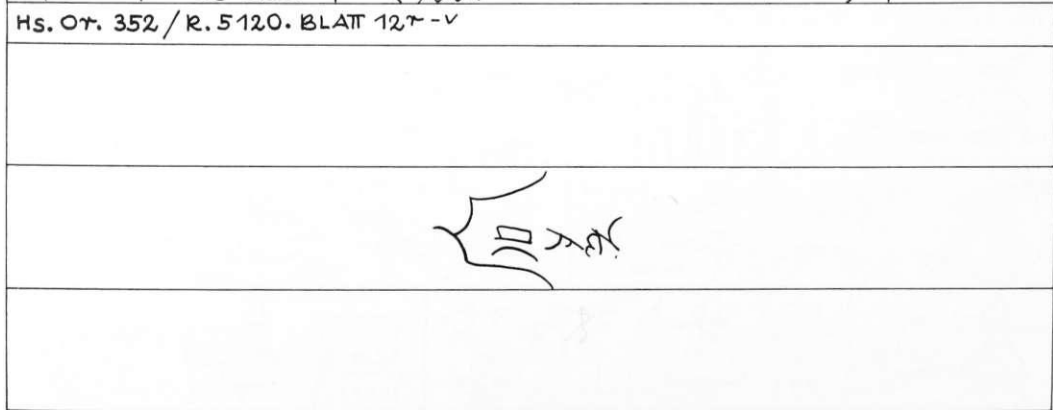
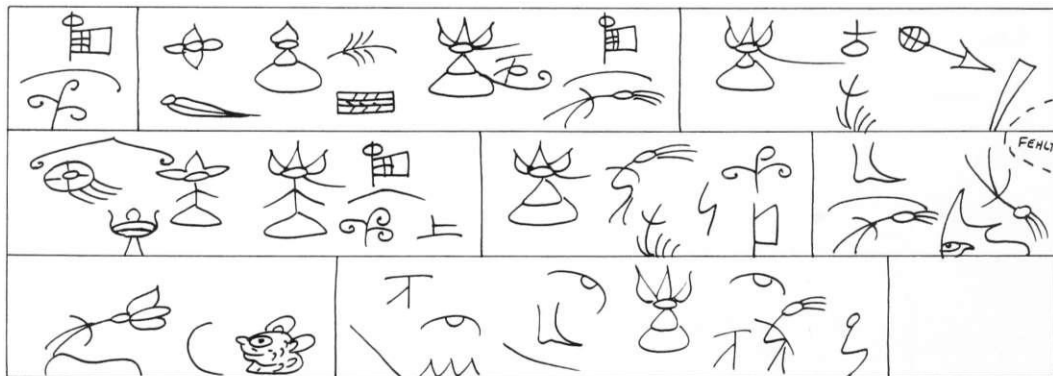
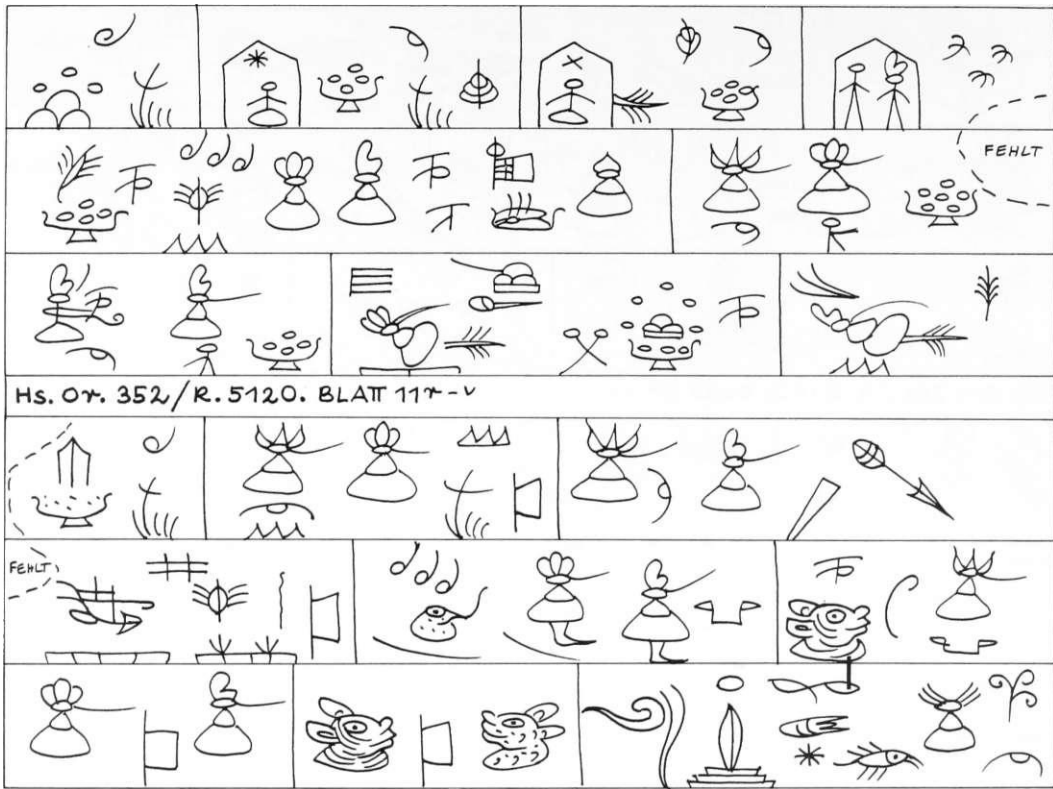

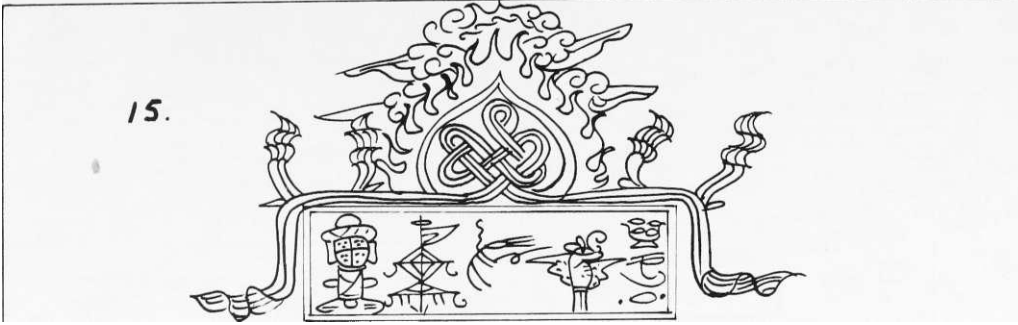

3HTT, 9^p- Hs. or. sim. 58*9 / R.118-1. HOLT- La-lLd fe'ö. Bpo-p'a-9^0 shu.. BLAT

NeruN» CH INJ. =fceiCHeNJ •
Z.UH Teil- UNLE-SerÜCH

ii ^ ir ft

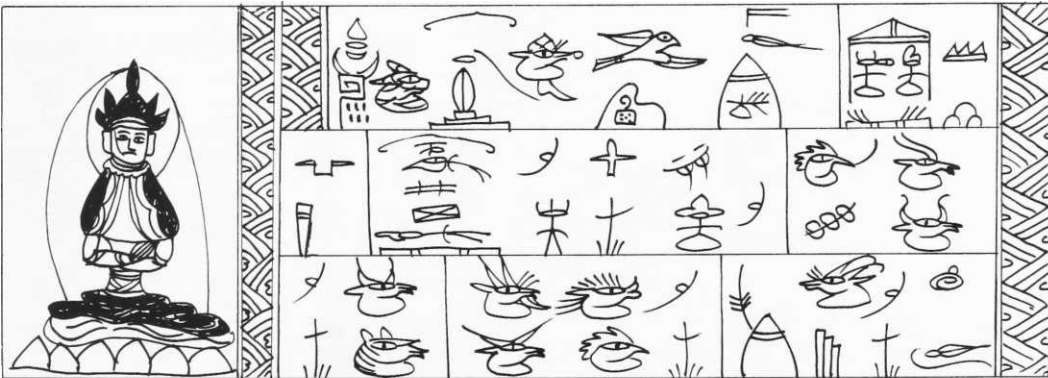

Hs. Or. sim. 589 / R. 1181. BLAT 27-v



- a l		Ts "	
Hs. or. sim. 559/R.		BLATT 3i>-v	
		25	

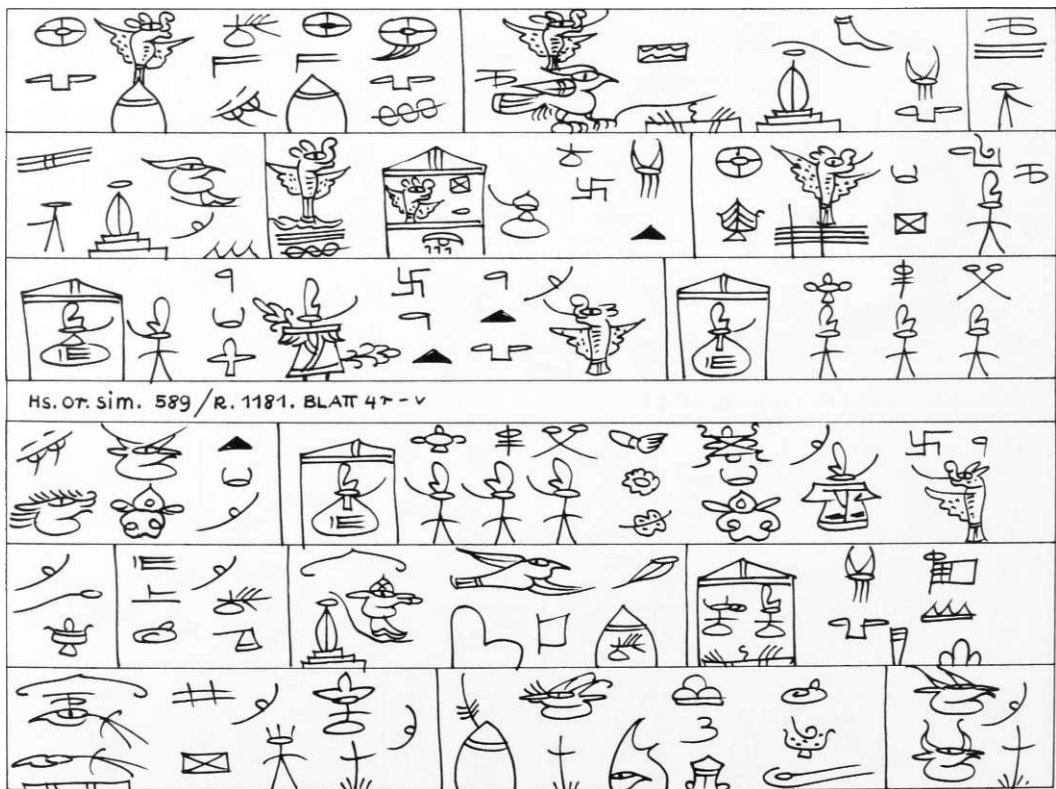

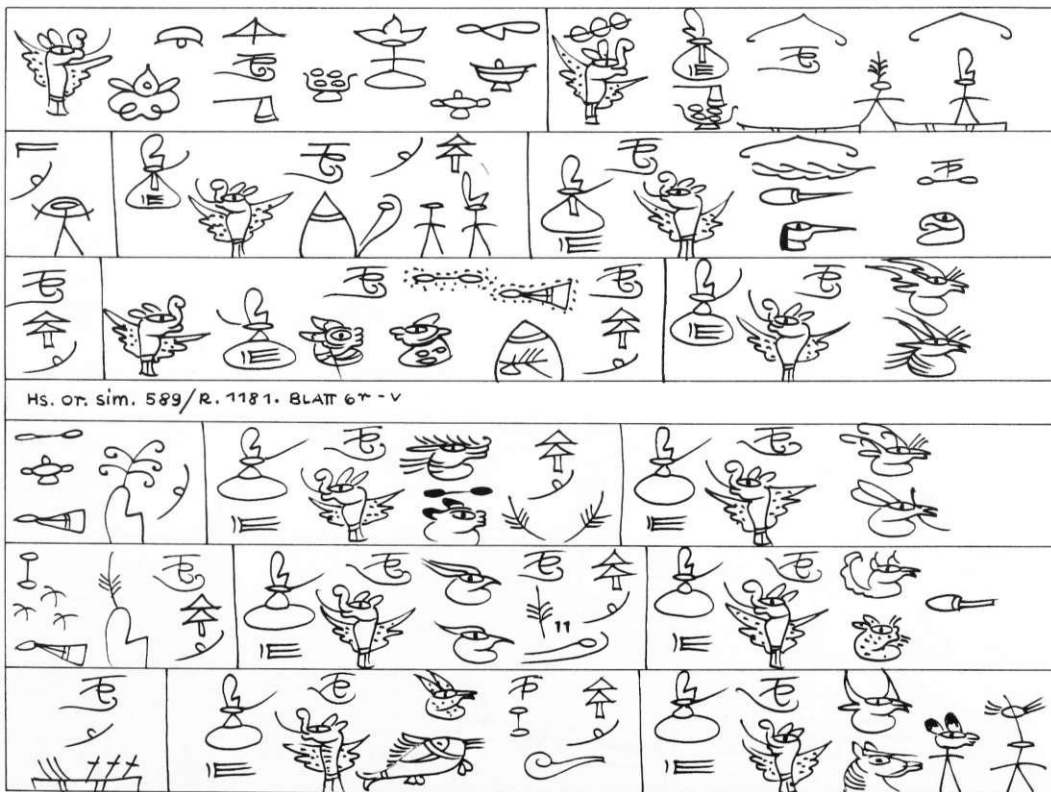
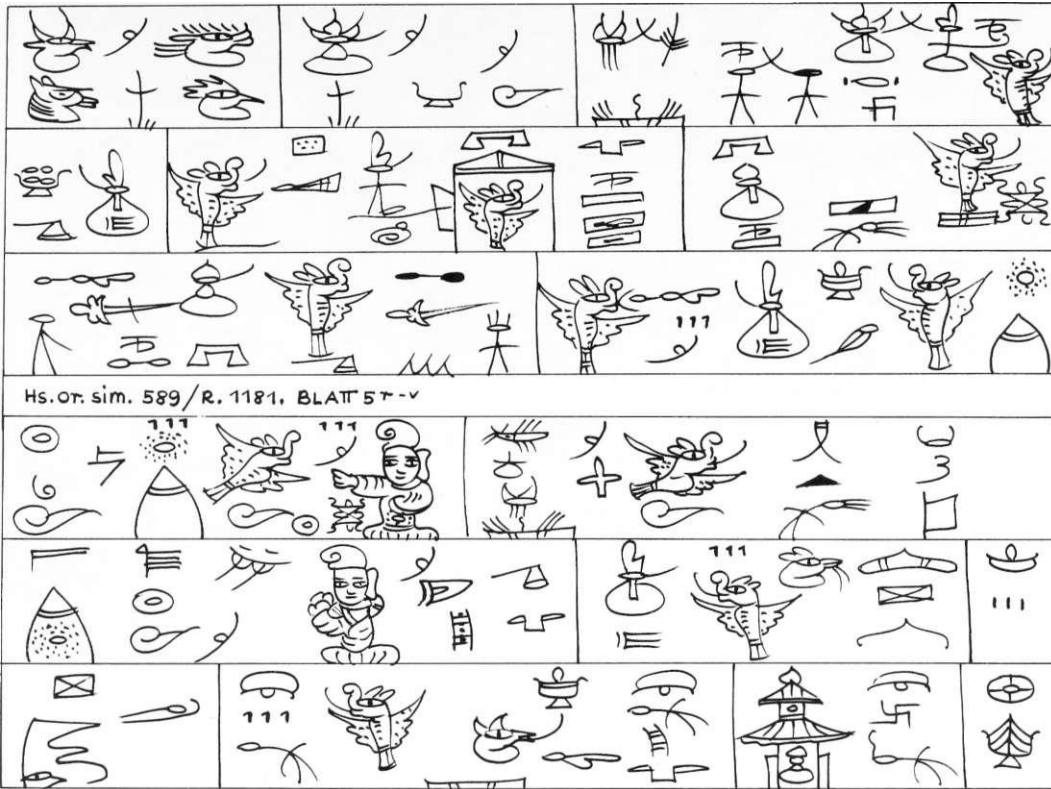

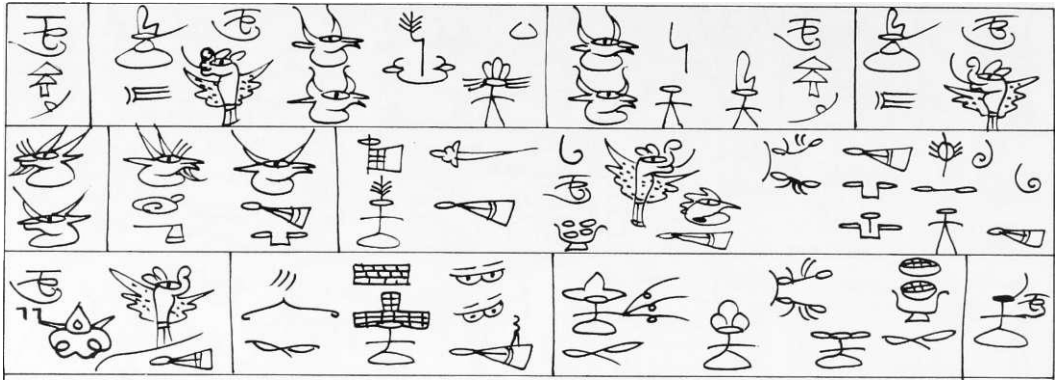

Hs. or. sim.

-115>-1. BLATT 7^r-v

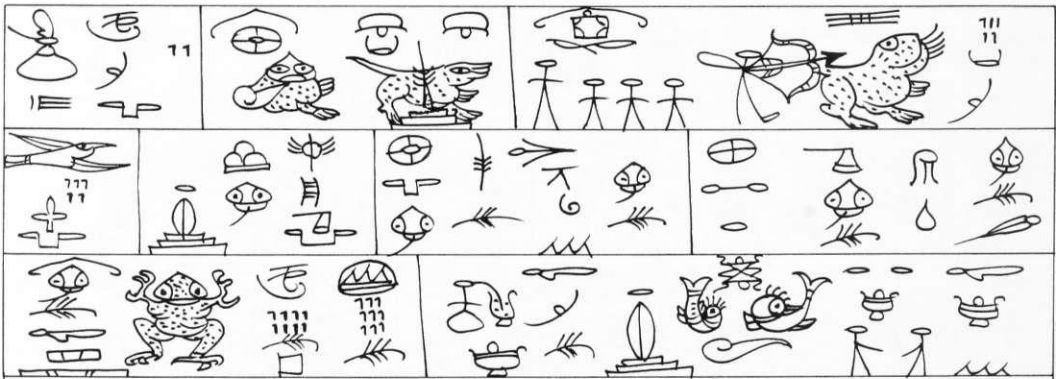
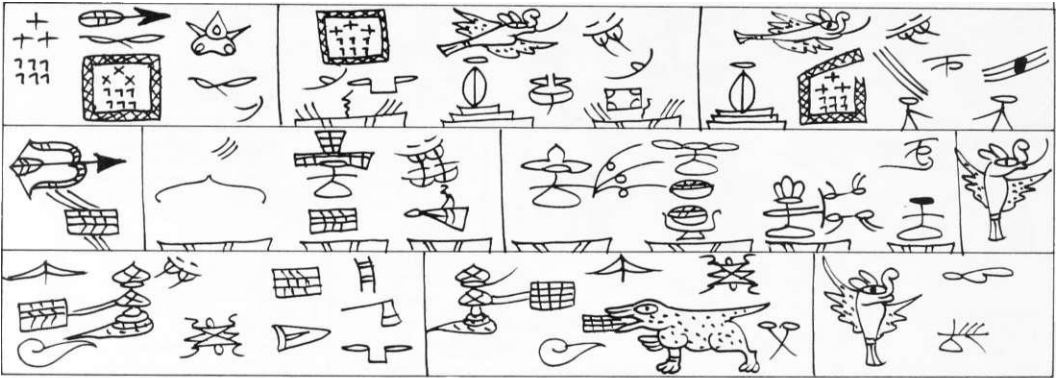

Hs. or. sim. 589 / R. 1181. BLATT 8^r-v

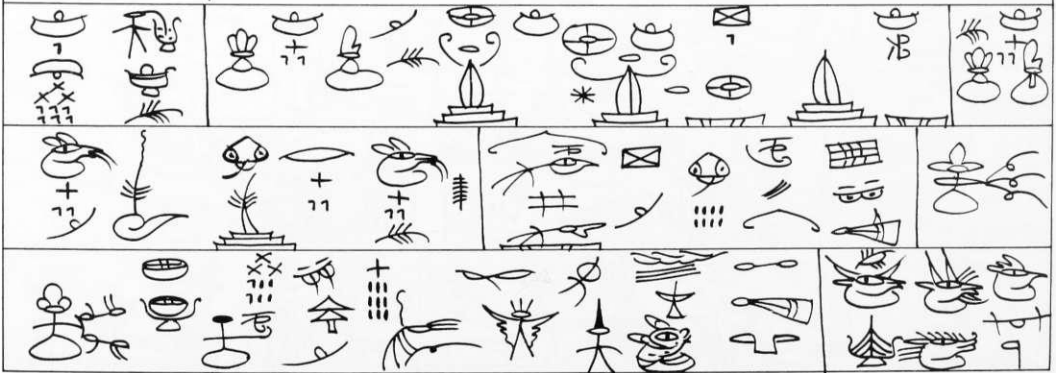

X
111
H I
(11



-R

x

in
in



4 -



AAA



AAA

AAA



Hill M|

AAA

Hs. or. -sim. 589/6. ns-t. BLATT 9T*-V

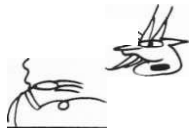
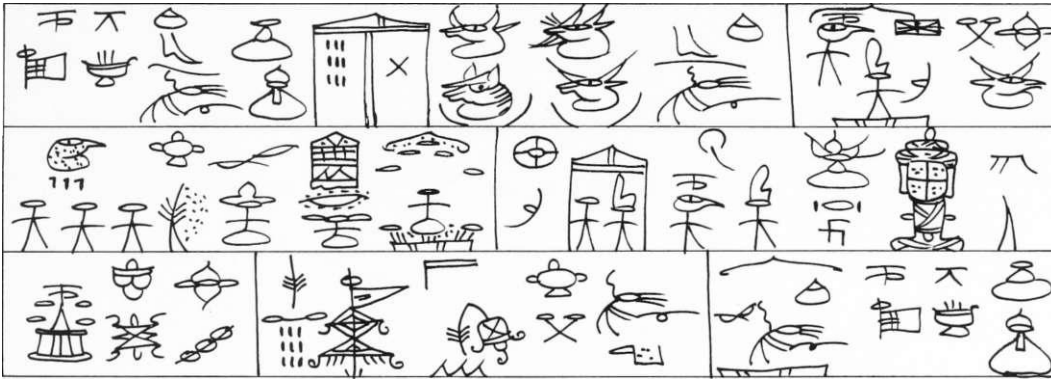

P

HS. Or. Sim. 5ff9/R.115'-i. BLATT "10^



XIII, 97, q - Hs. Or. sim. 553 / R. 697. Här la-llü rö. Tso mbër tü-gkv. BLATT 17-v

16.

ROCK:

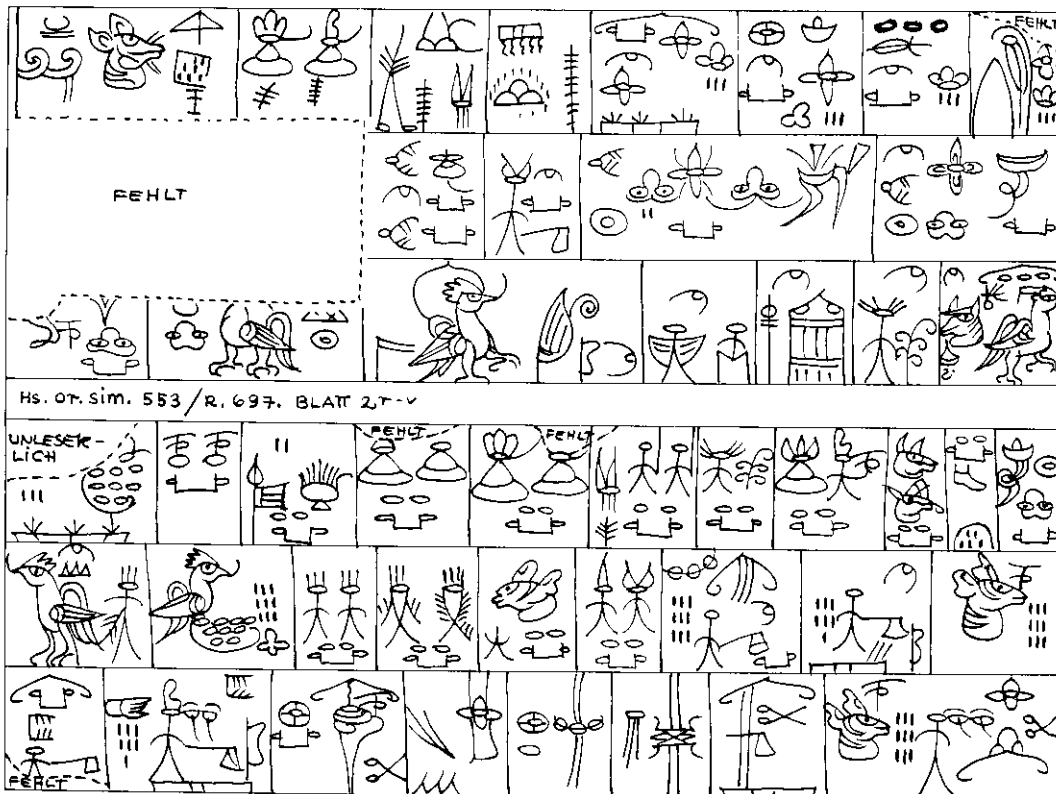
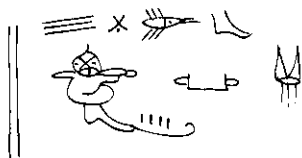

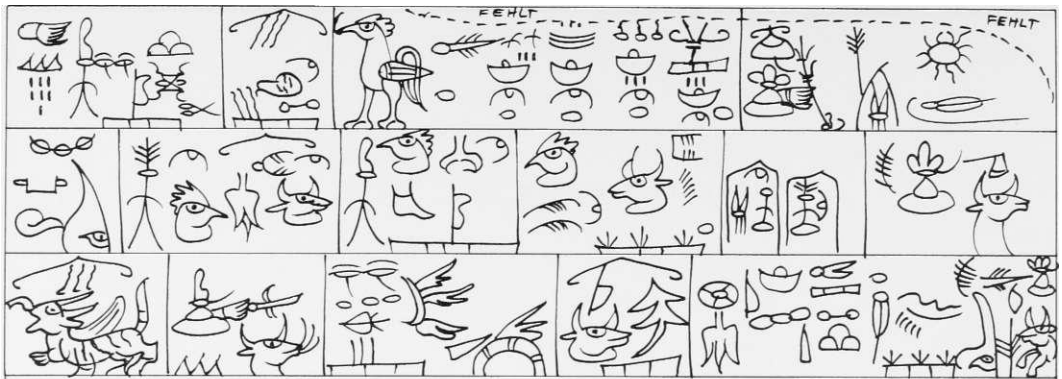

Hs. Or. sim. 553 / R. 697. BLATT 3 r-v

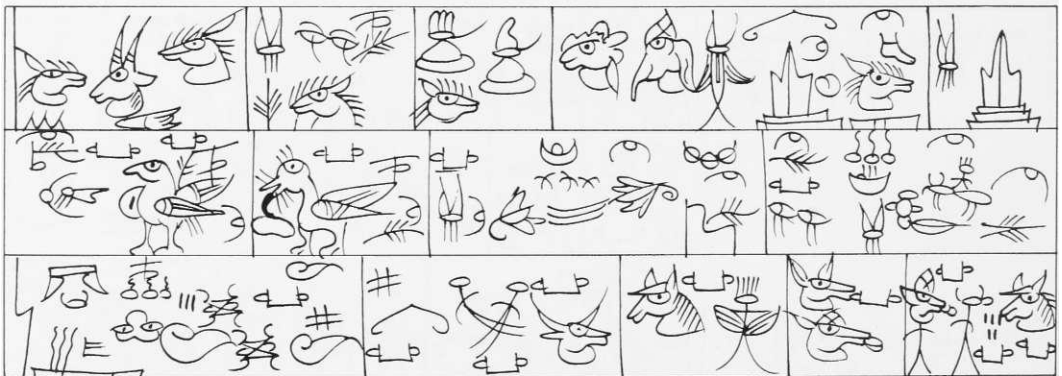
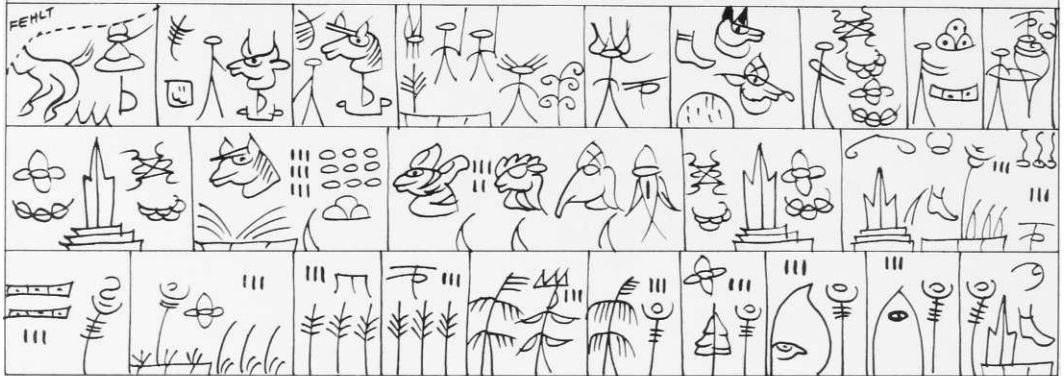

Hs. Or. sim. 553 / R. 697. BLATT 4 r-v



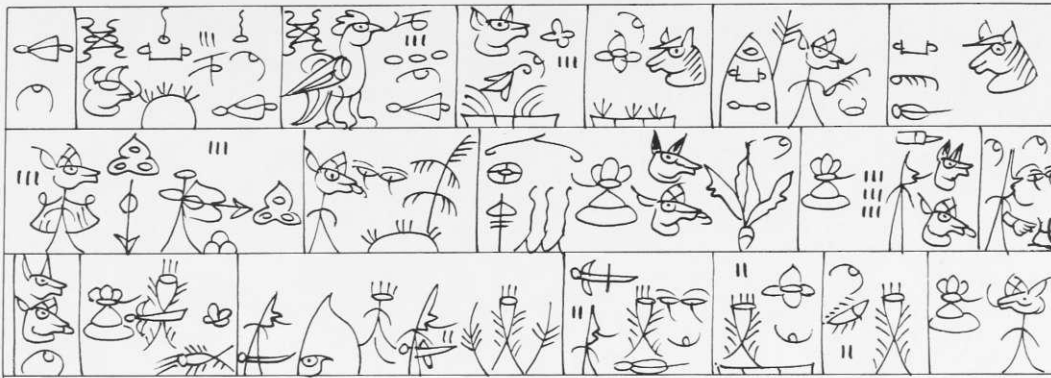

Hs. Or. sim. 553 / R. 697. BLATT 5 r-v

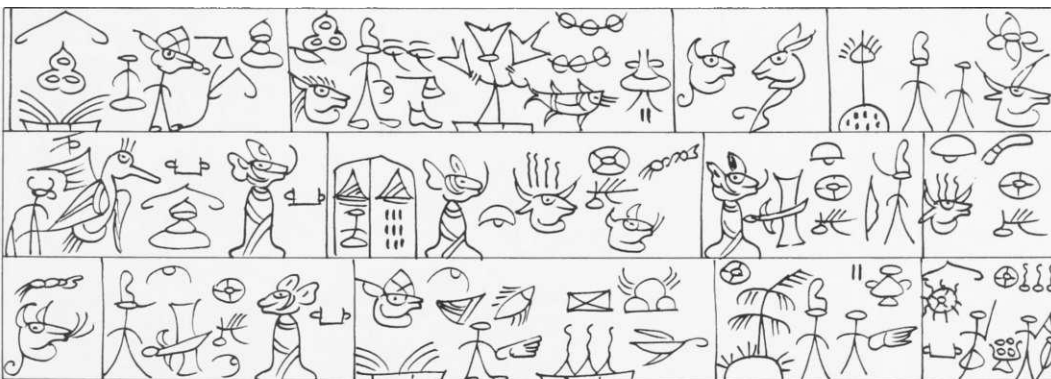
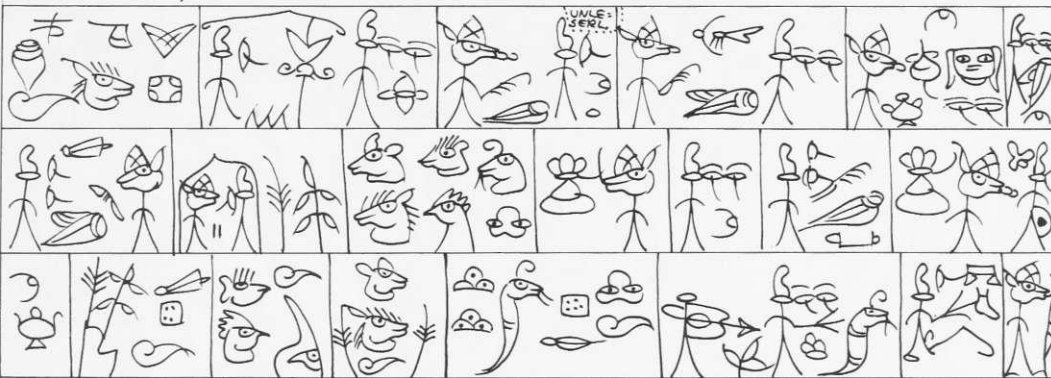

Hs. Or. sim. 553 / R. 697. BLATT 6 r-v

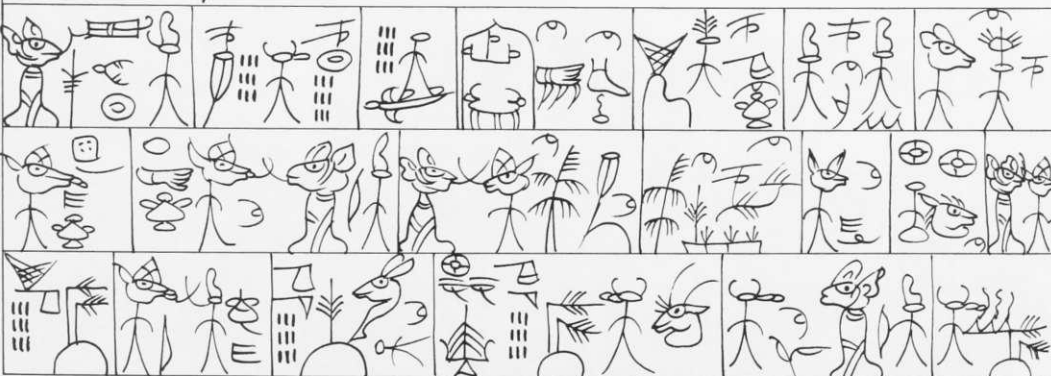

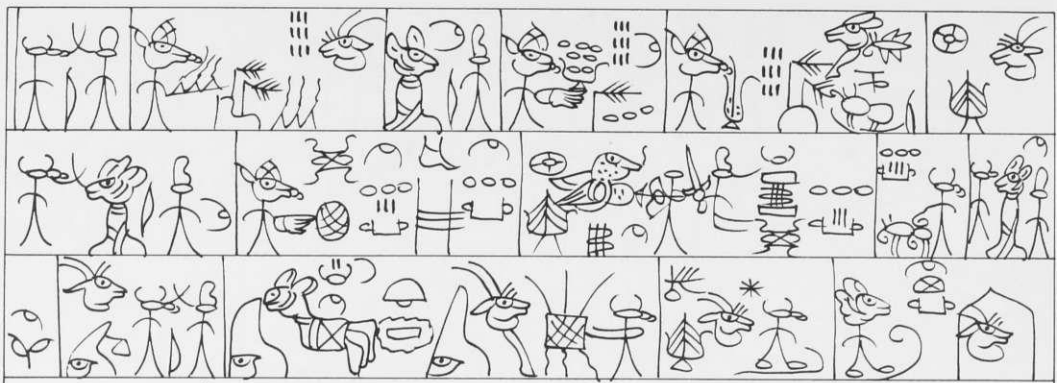

Hs. OT. sim. 553 / R. 697. BLATT 7 T-V

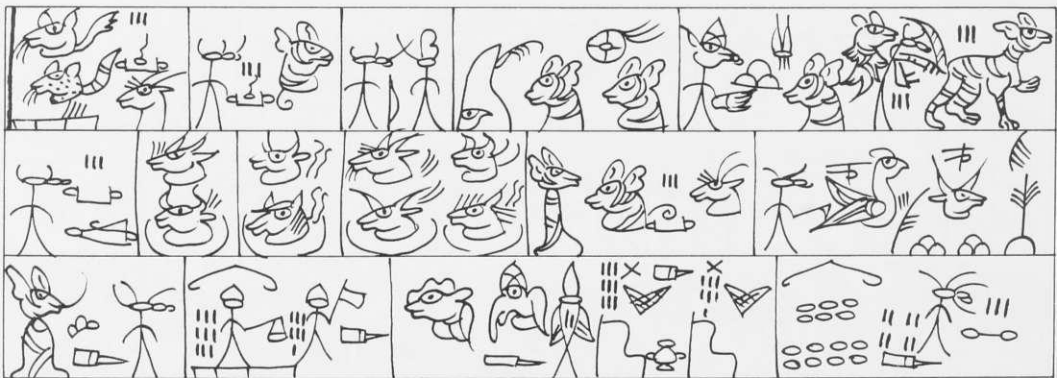
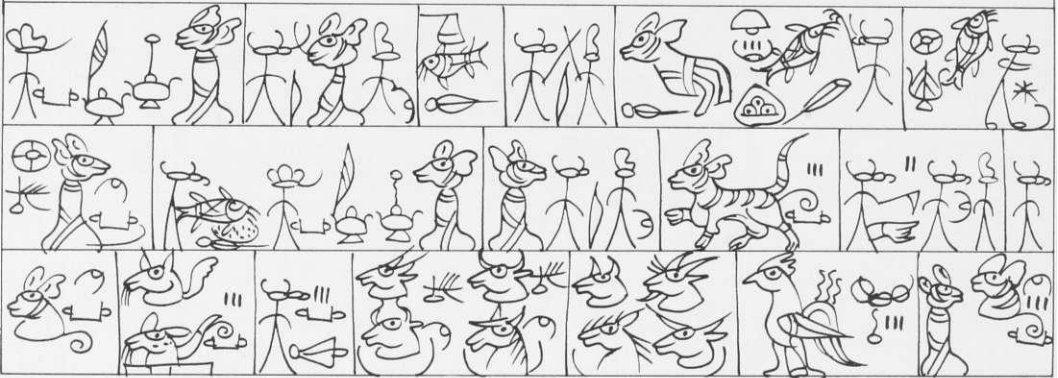

Hs. OT. sim. 553 / R. 697. BLATT 8 T-V

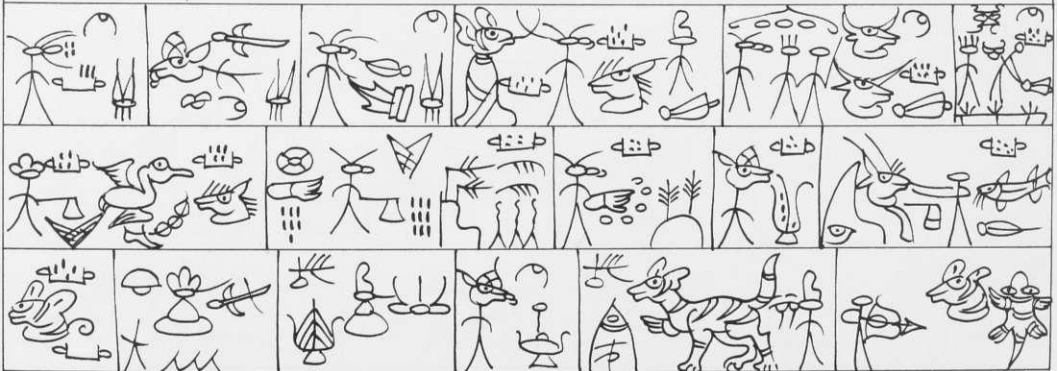

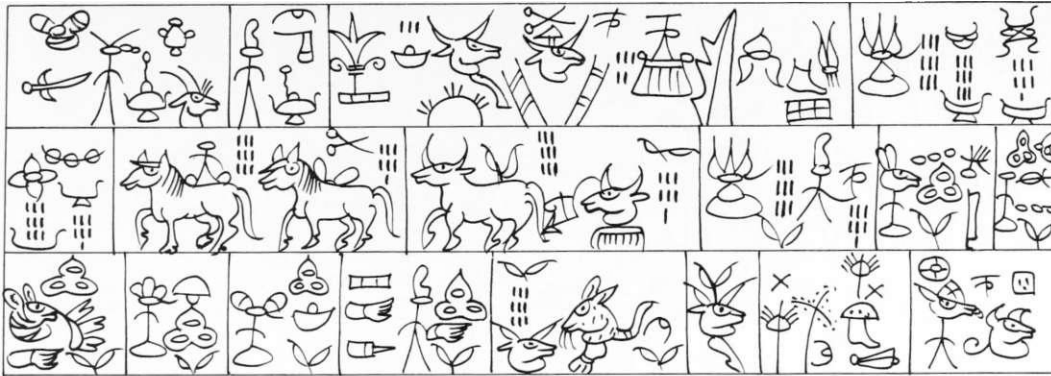

Hs. Or. sim. 553 / R. 697. BLATT 9r-v

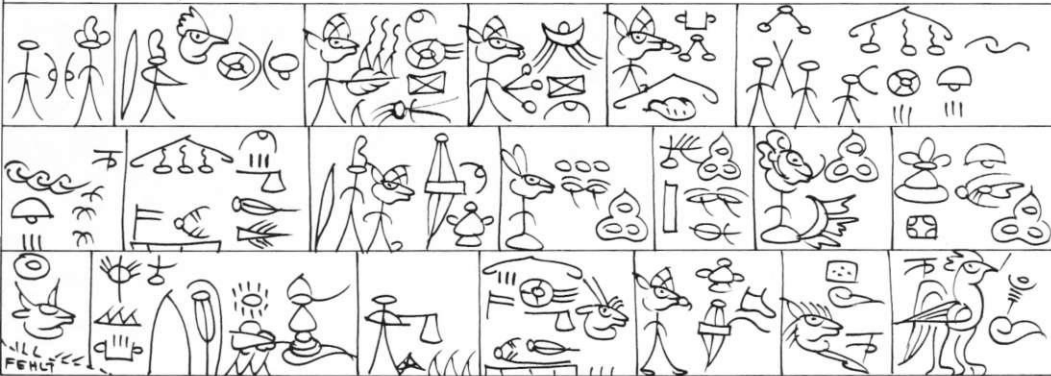

Hs. Or. sim. 553 / R. 697. BLATT 10r-v



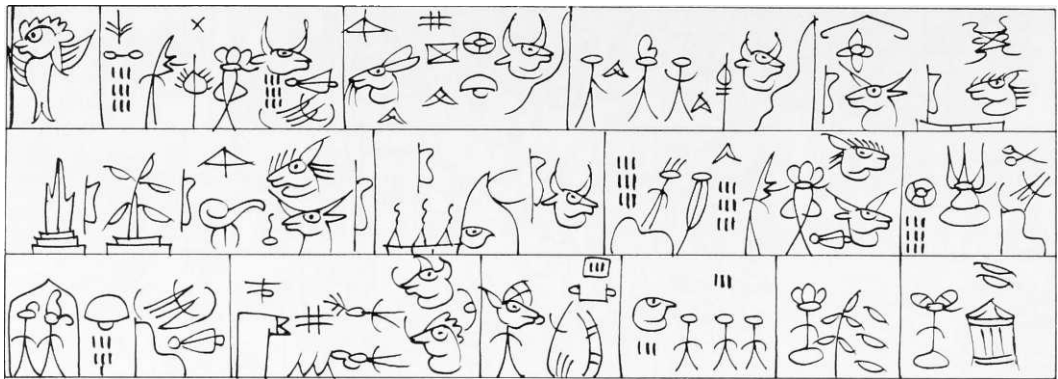

HS. or. sim. 55-3>/R..fe9=7-.BLATT tl-r-v

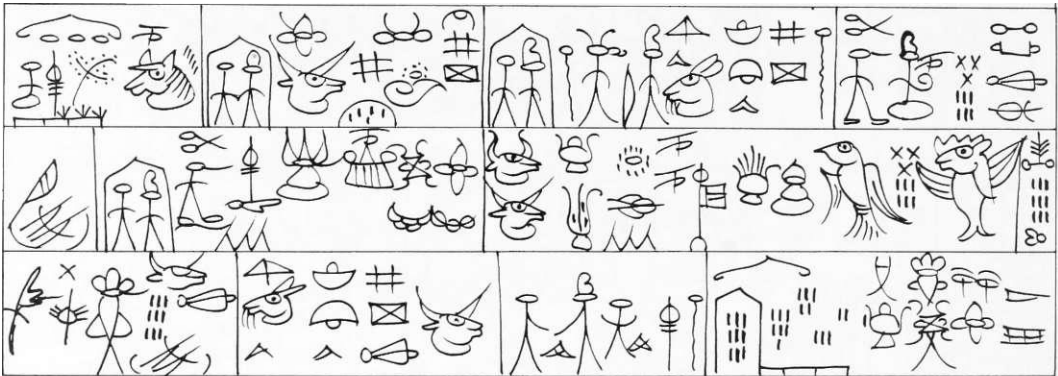

HS. OT. sim. 553/R. 697. BLATT 12 T-V

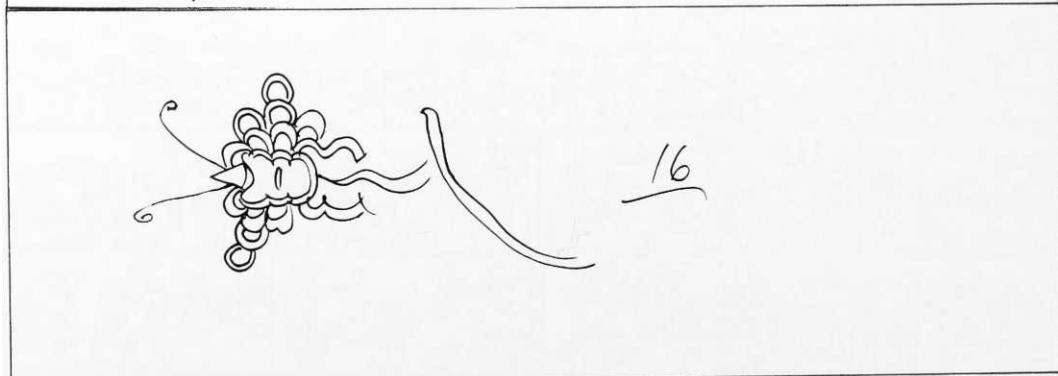

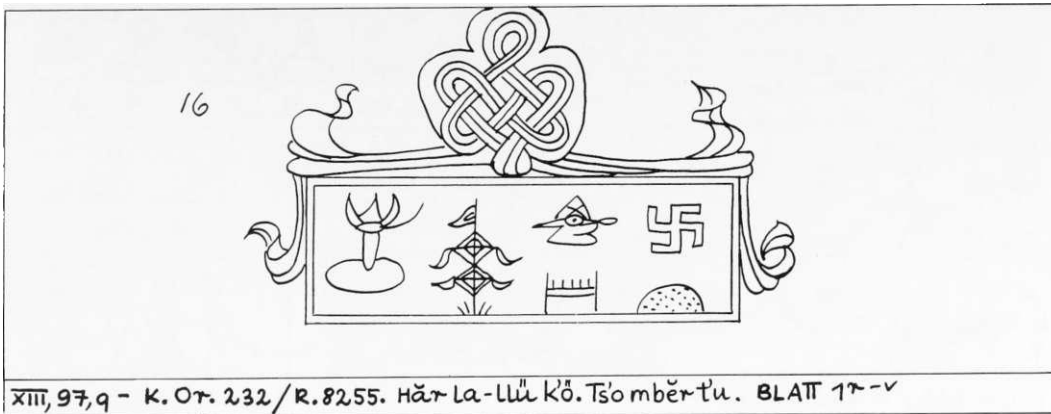

ROCK:

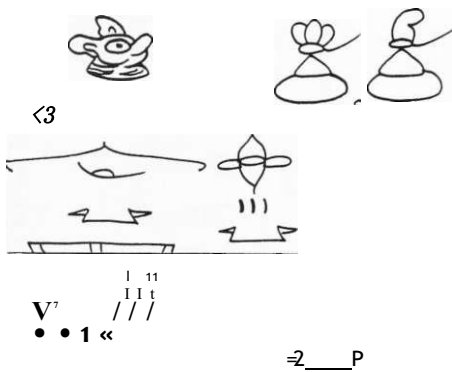

L « 3

» 1

K. Q 1 M 3,33, /ft. g^SE. BLATT %»

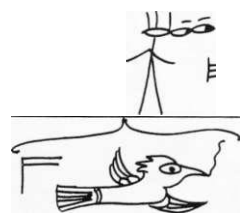
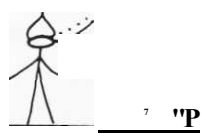

X



&

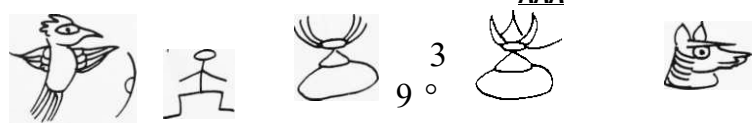

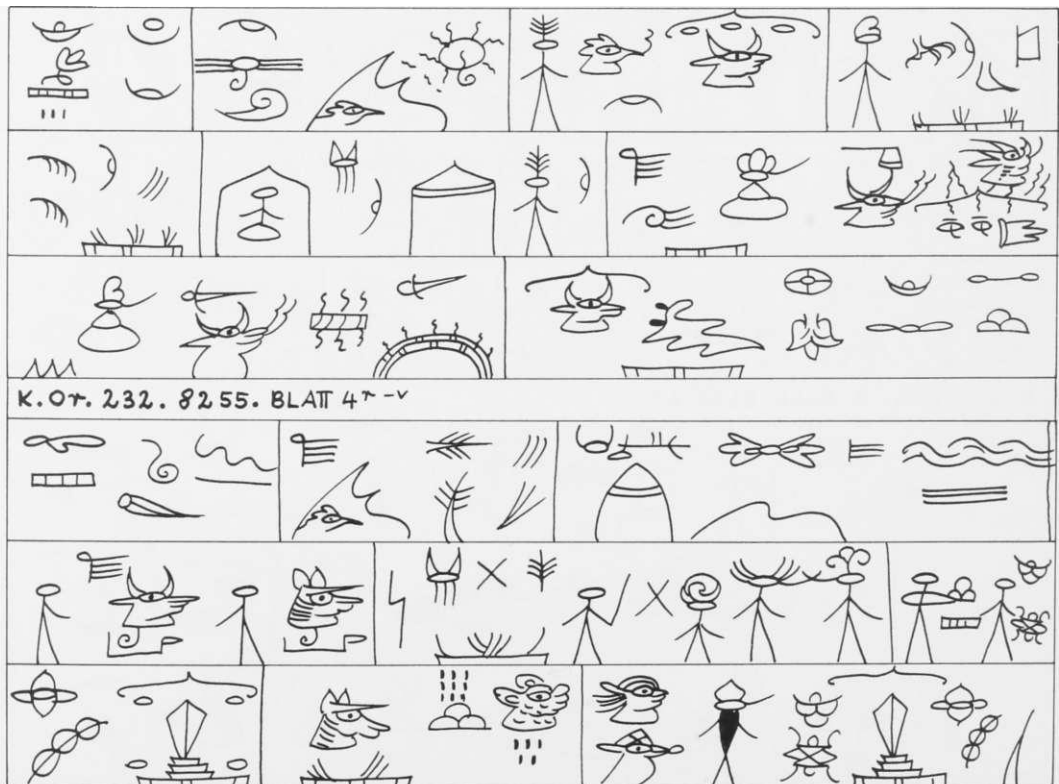
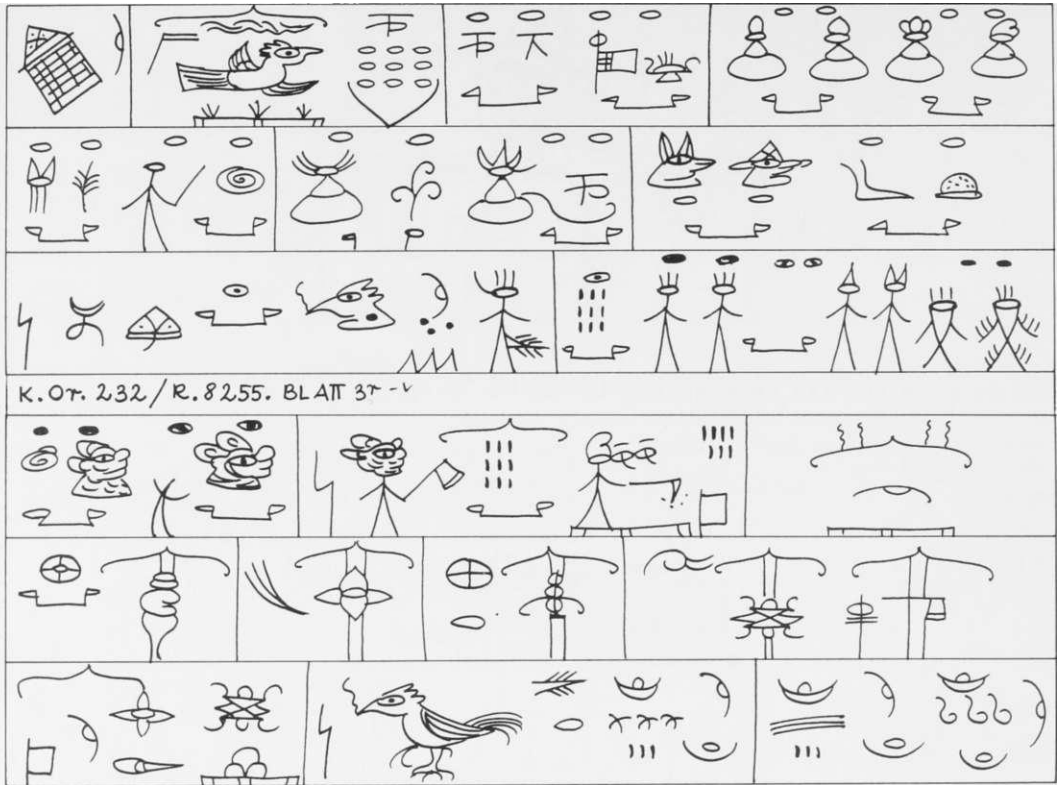

n in		
W A		
K. O T K 2,2,1 / fc. 8155. BLATT S ^ - ^		



-EC



11)
= R



11
II & MI
II

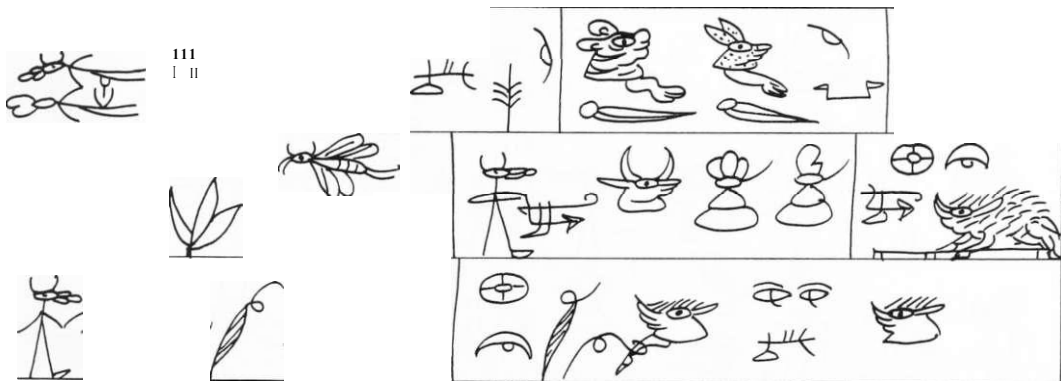
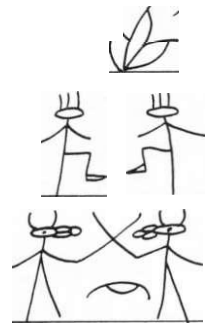

K. Of. 3,3X/fe. S15S. BLATTfc'''-

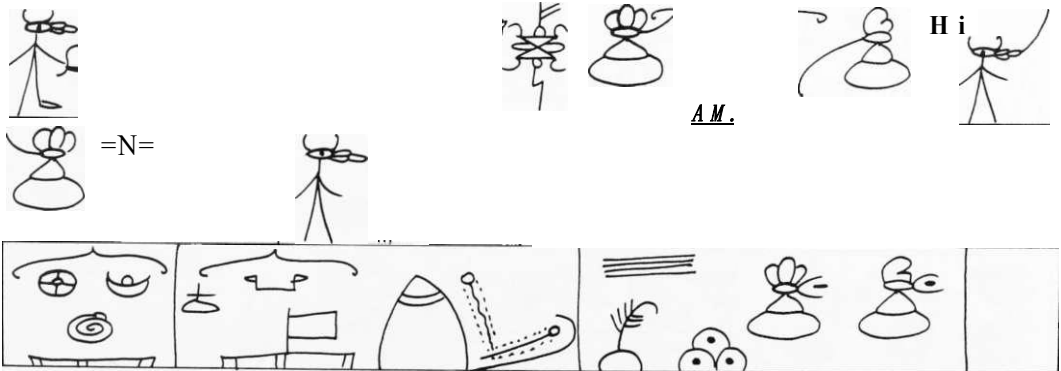

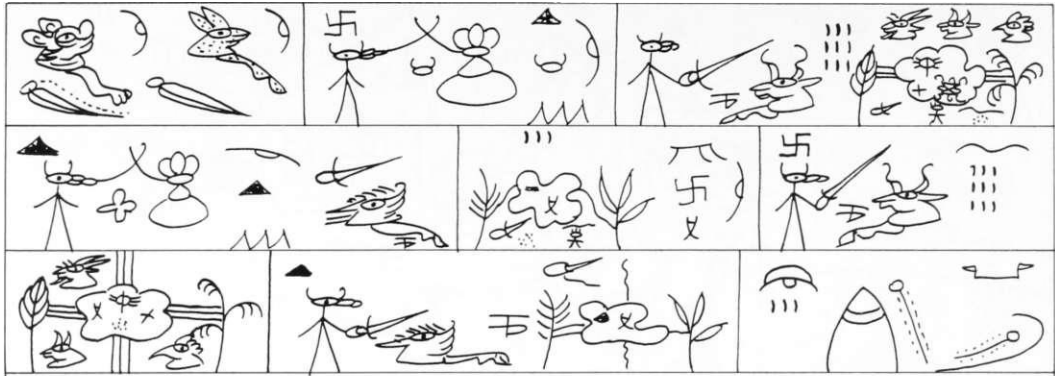

K. O. 232 / R. 8255. BLATT 7r - v

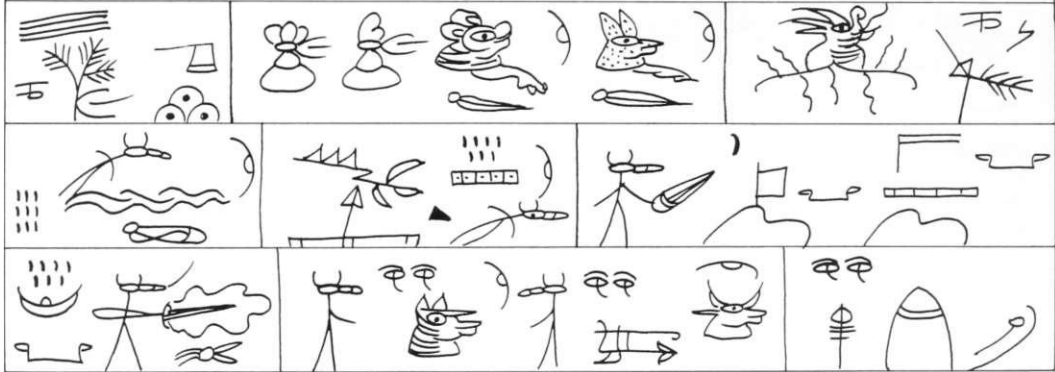

K. O. 232 / R. 8255. BLATT 8r - v

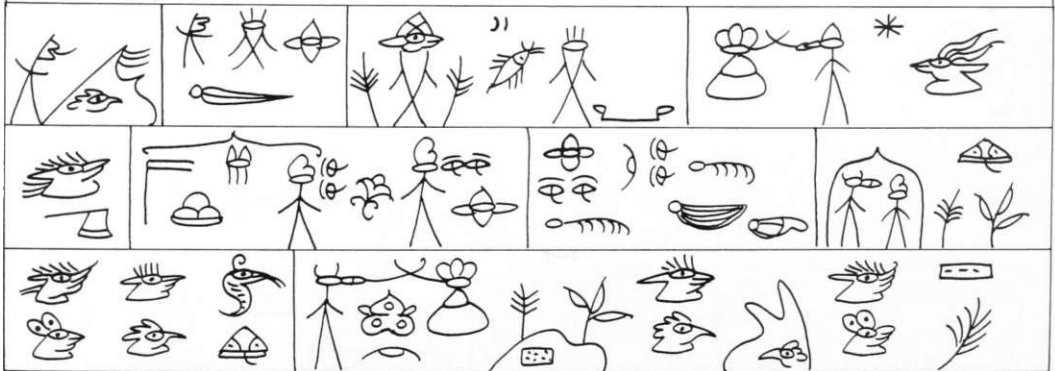

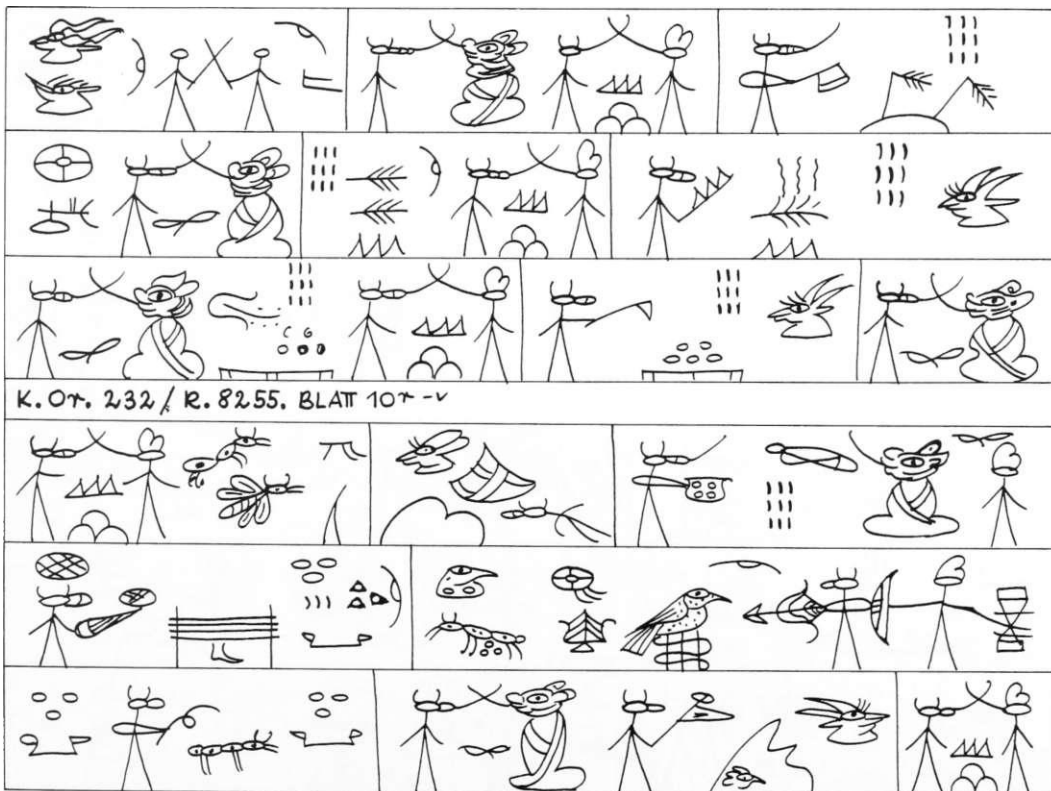
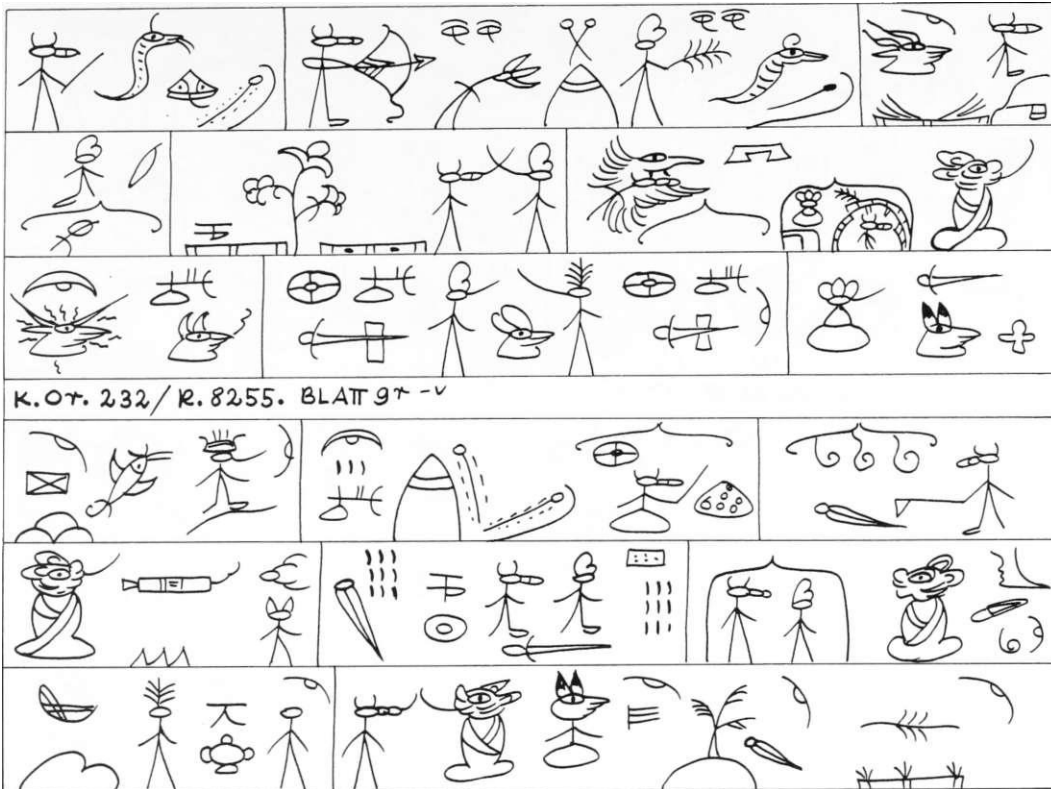

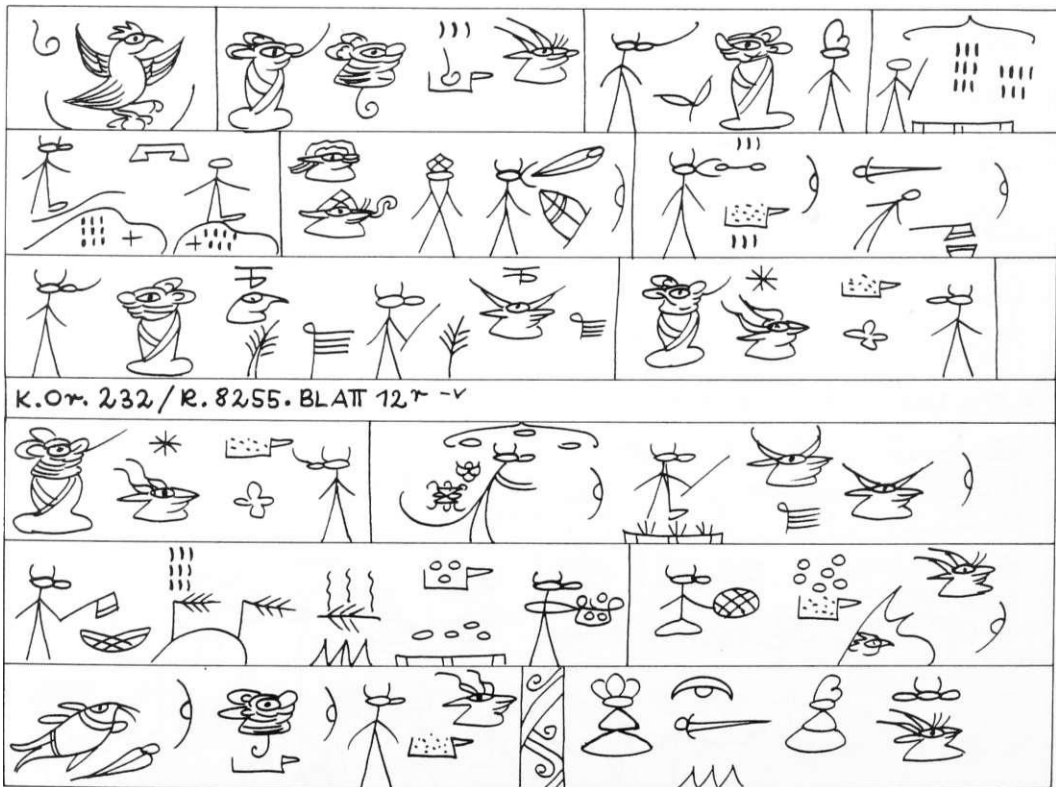
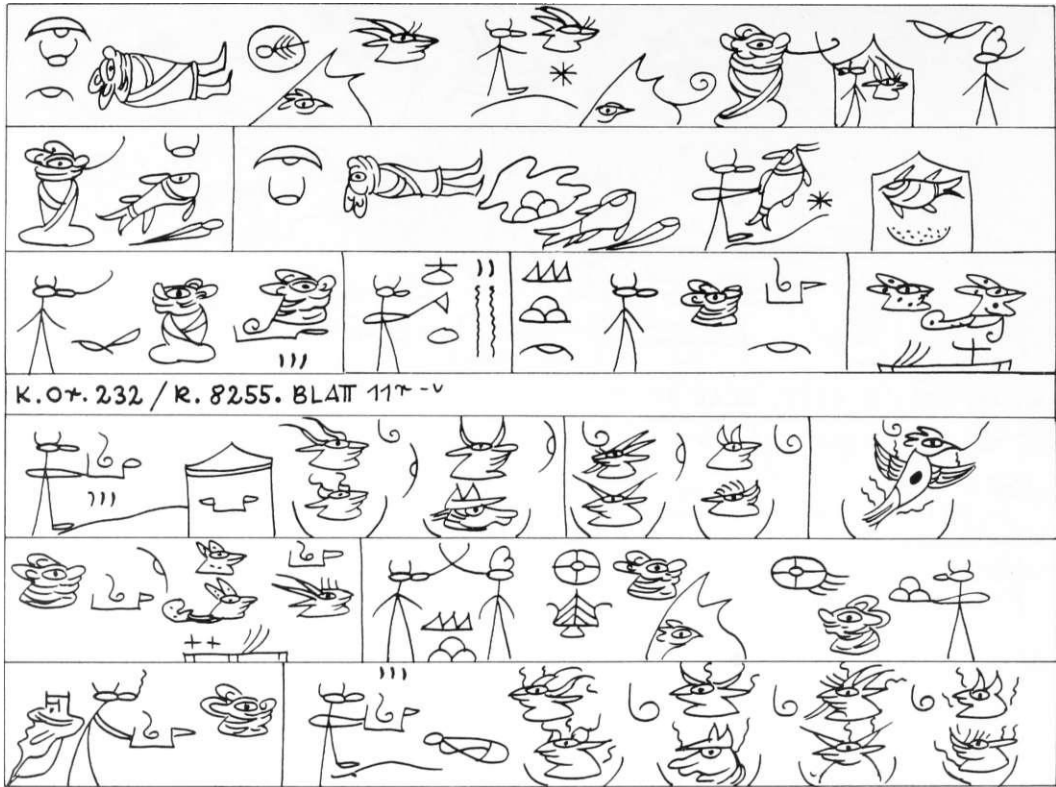

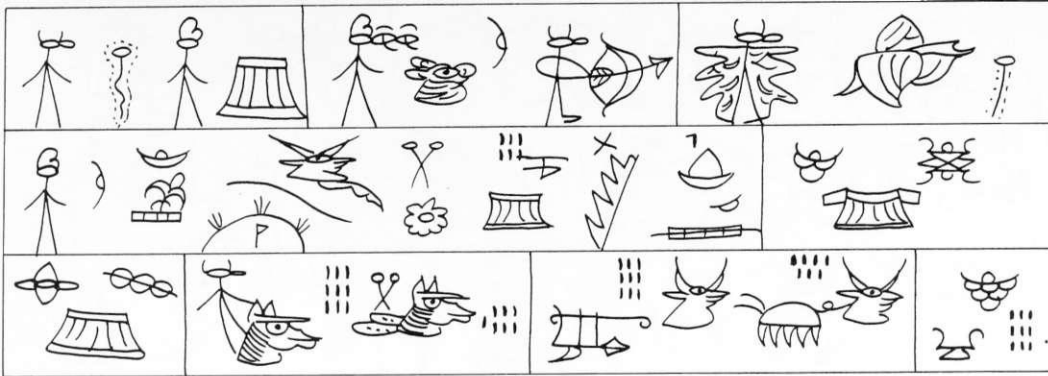

K. OT. 232 / R. 8255. BLATT 13^{r-v}

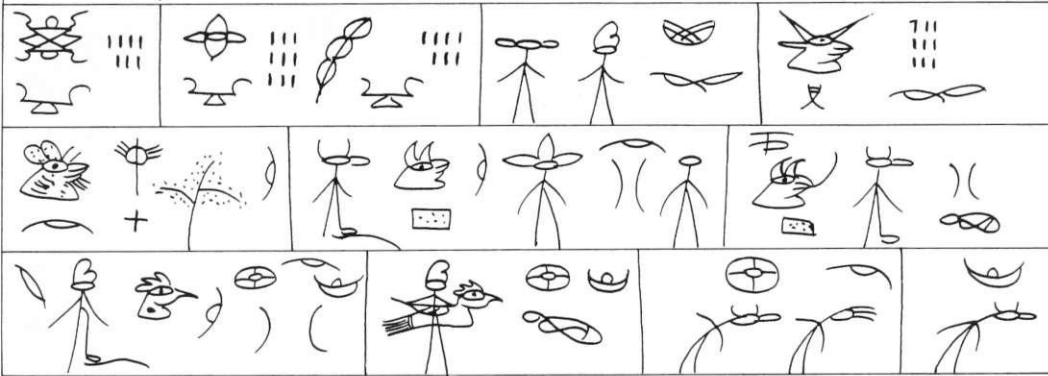

K. OT. 232 / R. 8255. BLATT 14^{r-v}

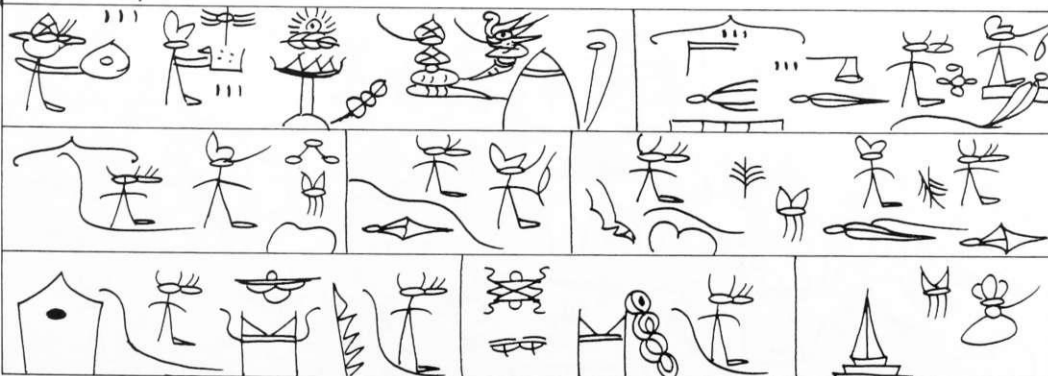

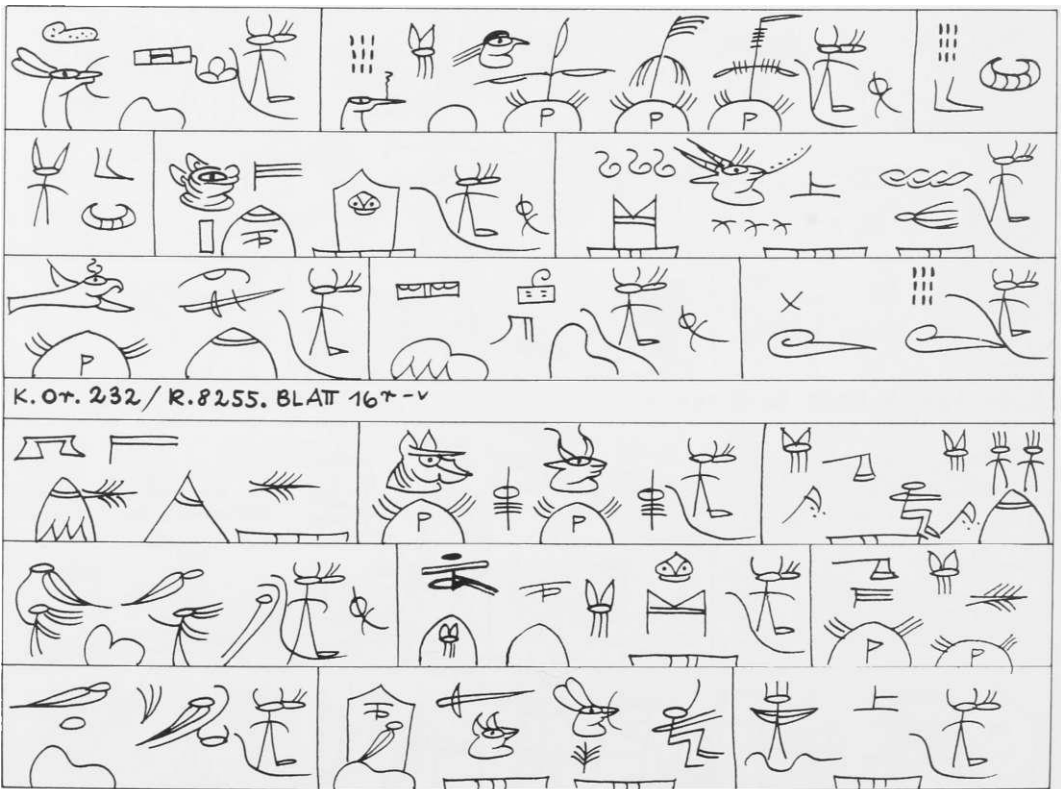
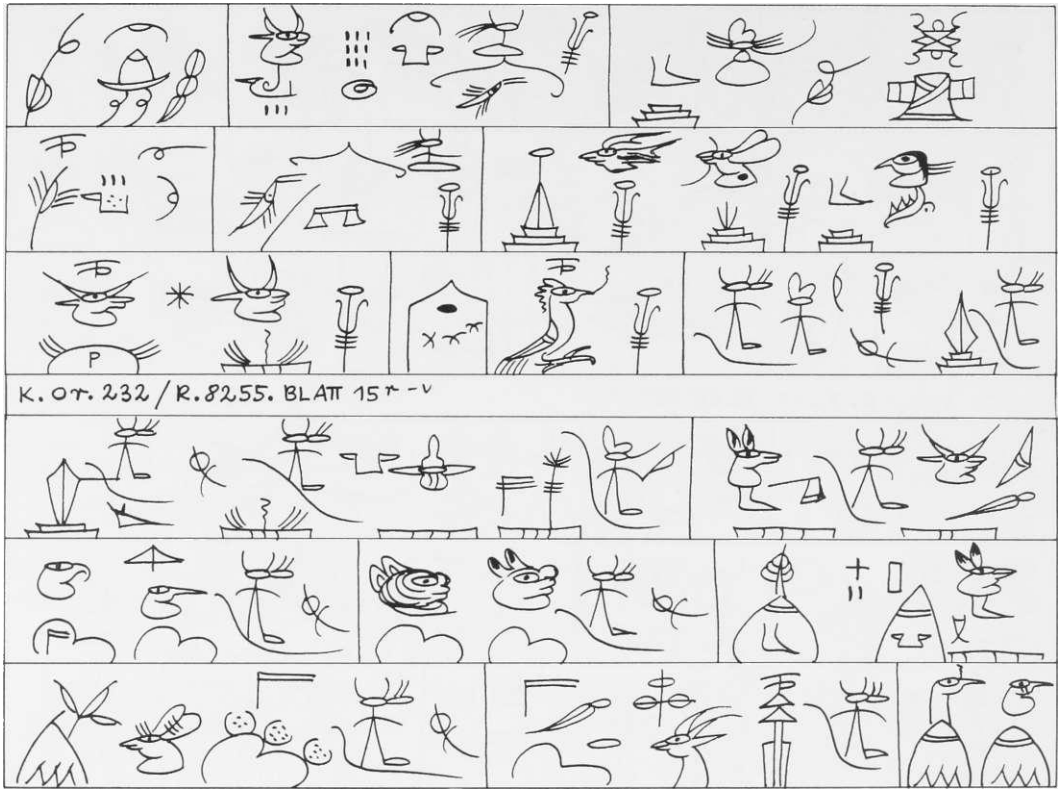

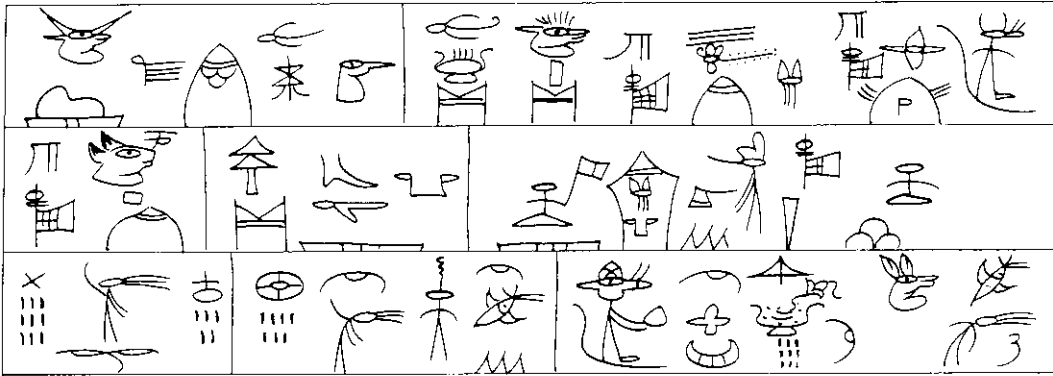

K. Ot. 232 / R. 8255. BLATT 177 - v

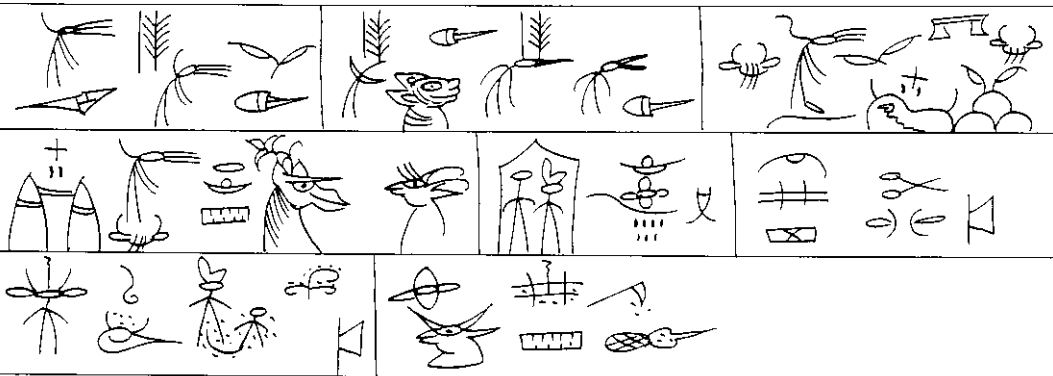
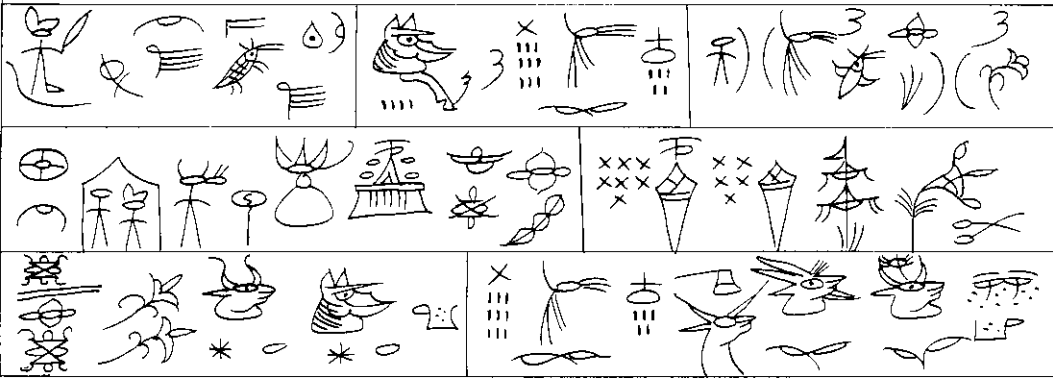

K. Ot. 232 / R. 8255. BLATT 187 - v

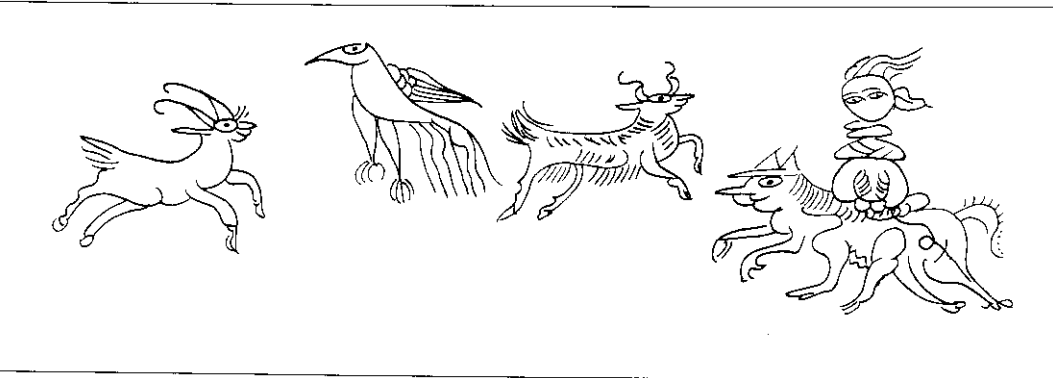

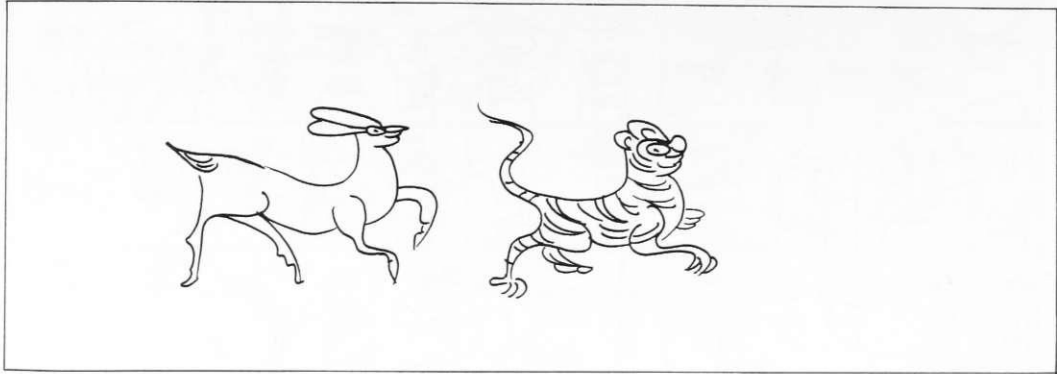

K. Or. 232/R. 8255. BLATT 19^r

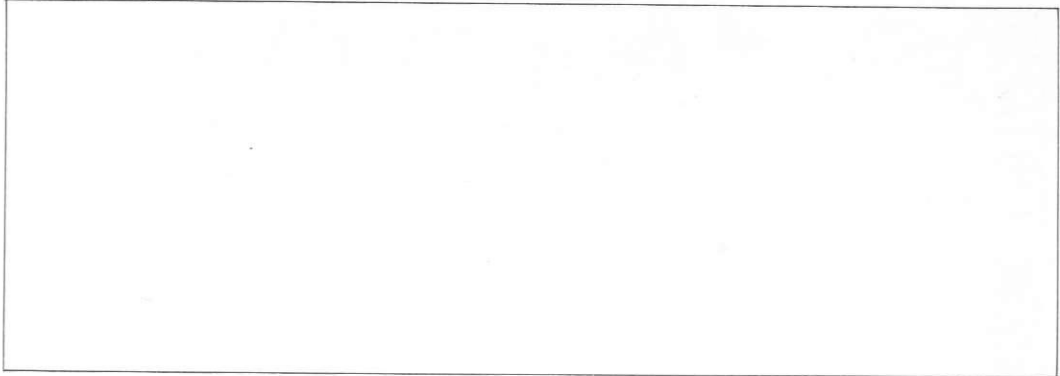

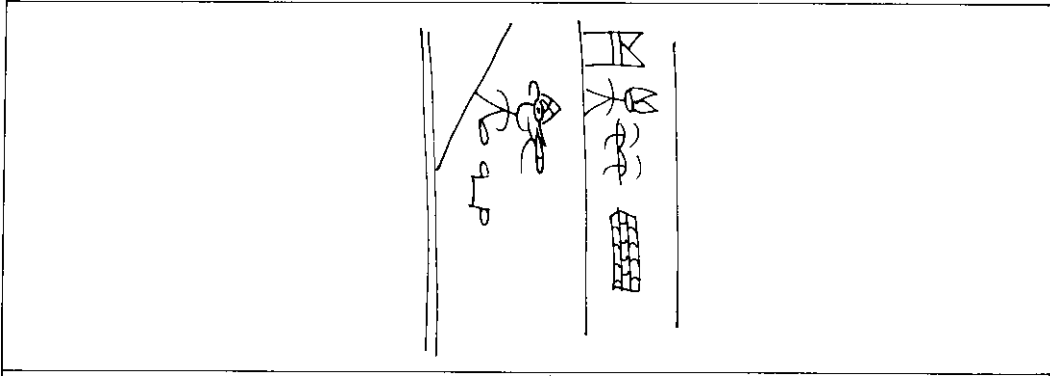

x»n,9^q ~ K.Or.41\$/R.ff532,. Har La-lülko.Ts'o **mbertU**. BLATT



k.Or. 41\$/le.tf53^. BLATT 1				
				fr*ix

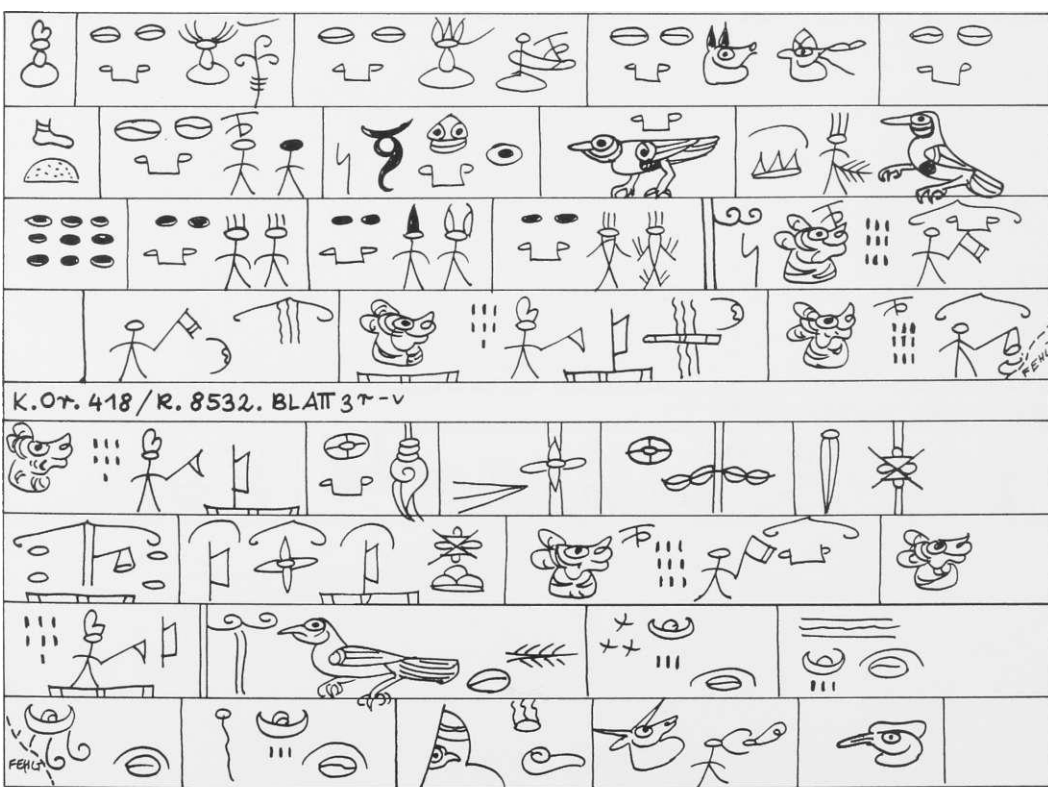
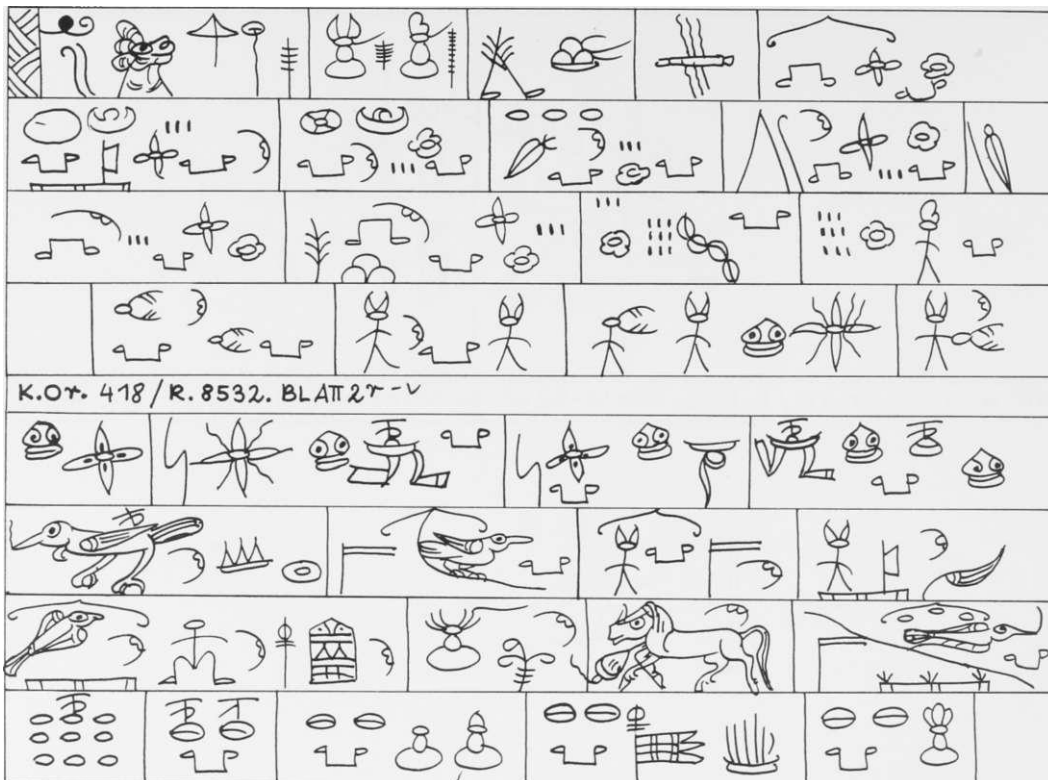

"S"V

				4(
	H-n-n	Ⓜ ^ ^ ^ ^ ^ ^ ^ ^ ^			IULV V ,r rv

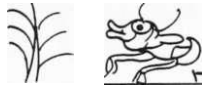

HWT



'TM



!!!

<3= <f=>



"LT



H1
in



in



TTÖ5>



7^



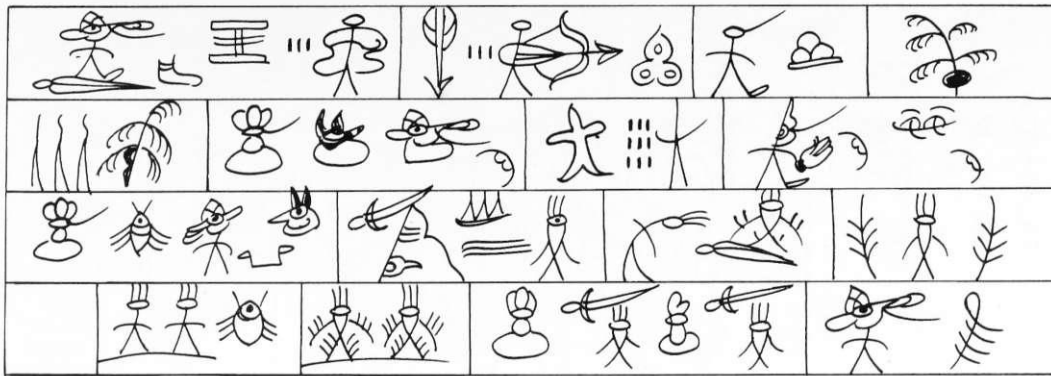

K.Ot. 418 / R. 8532. BLATT 8r -v

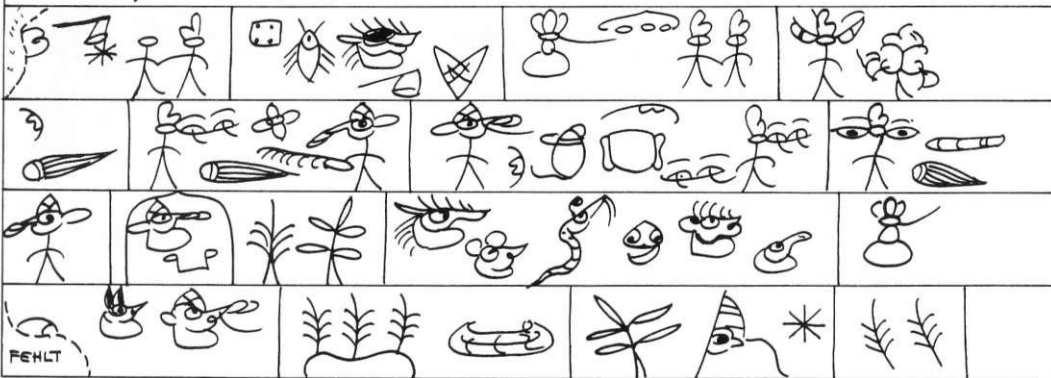

FEHLT

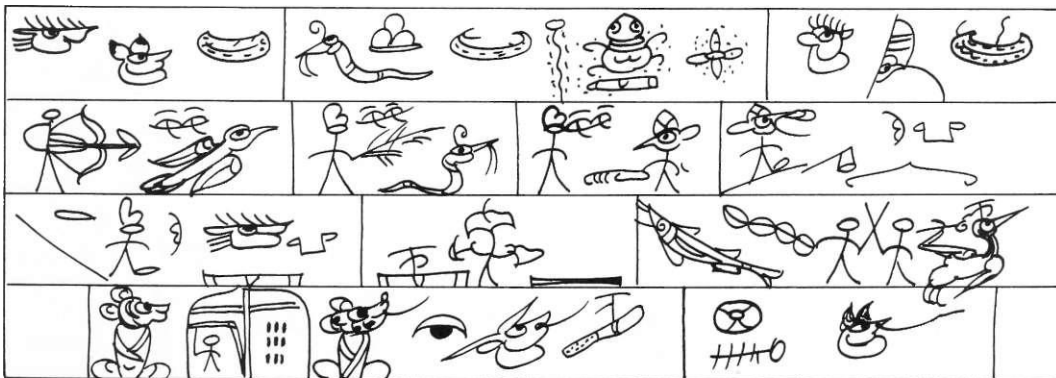

K.Ot. 418 / R. 8532. BLATT 9r -v

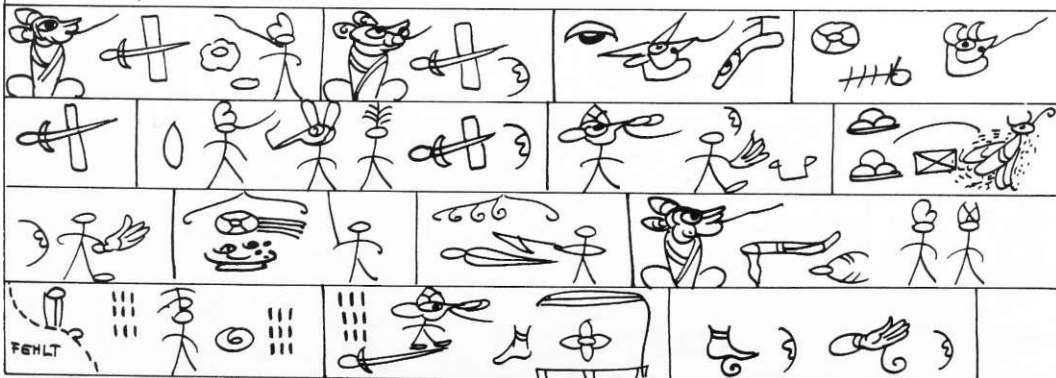

FEHLT

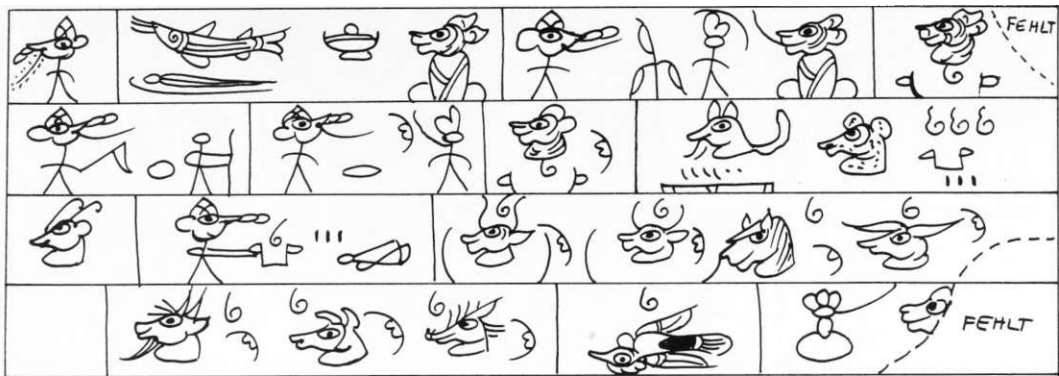

K.O+. 418 / R. 8532. BLATT 12r -v

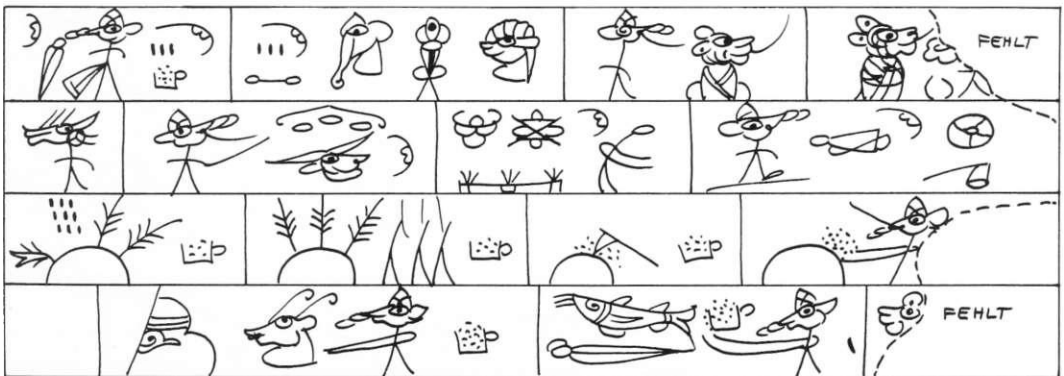

K.O+. 418 / R. 8532. BLATT 13r -v

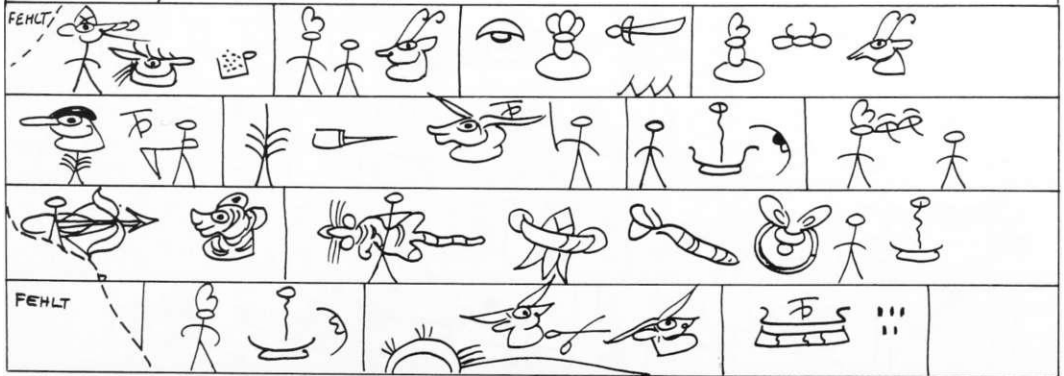

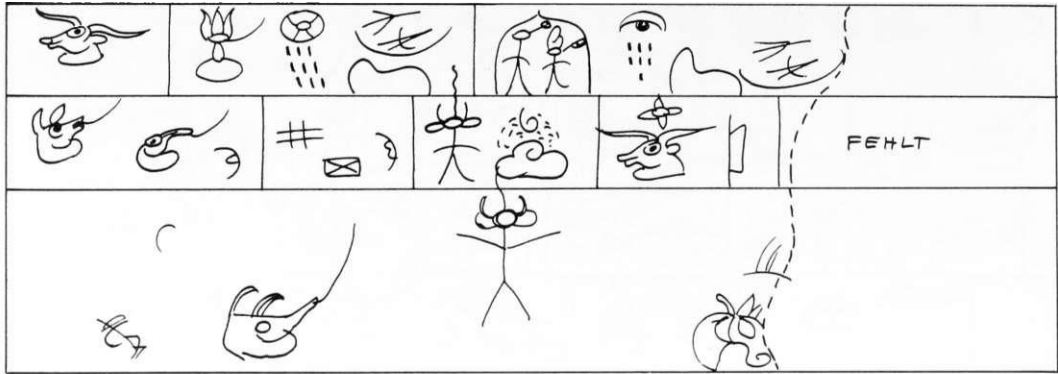

K.Ot. 418/R. 8532. BLATT 18^r

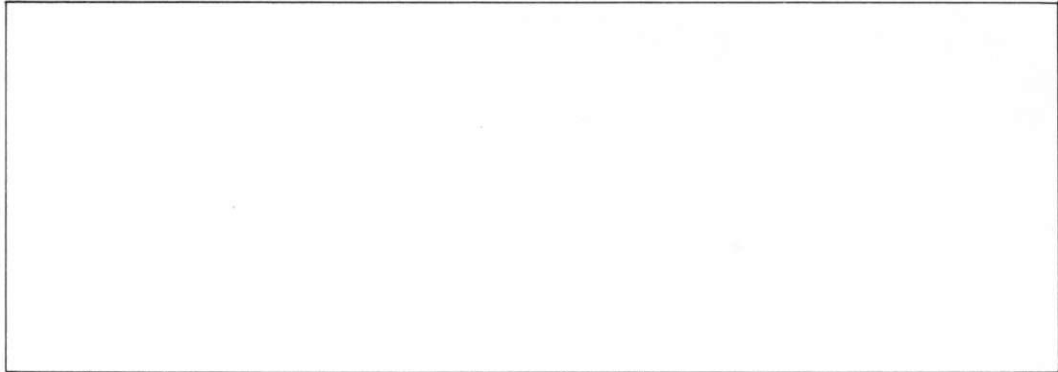

Oß.iq | MAL.TITEL FBHLT

XIII,9T,T--Hs.or.sim. ?oi/R.

Har la-llü. fe!ö. PW-Lassaw ya-Lo t'u--bbue. BLATT-1A-A

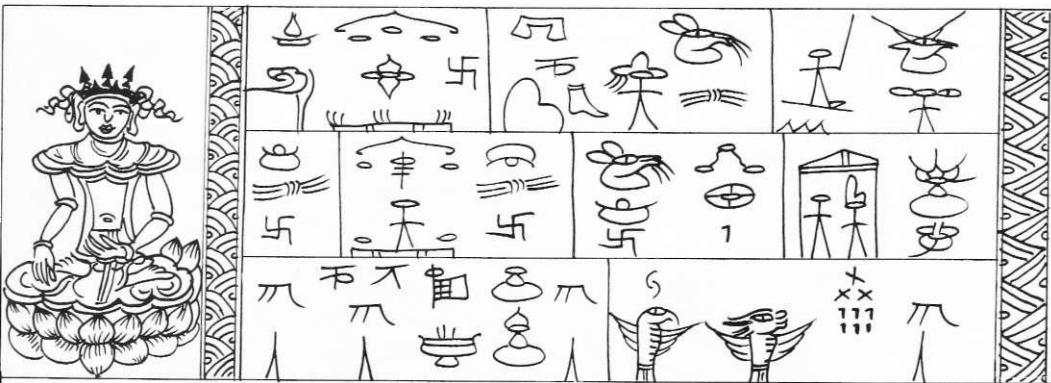
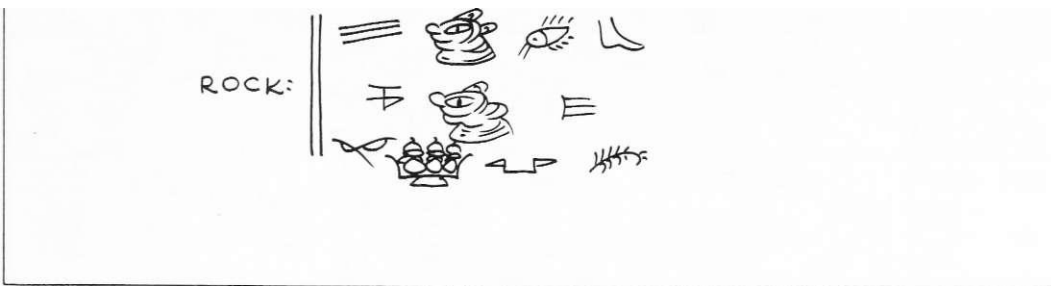

Hs.Or.sim. ^OI/R. 2,2,3?-. BLATT^r-v



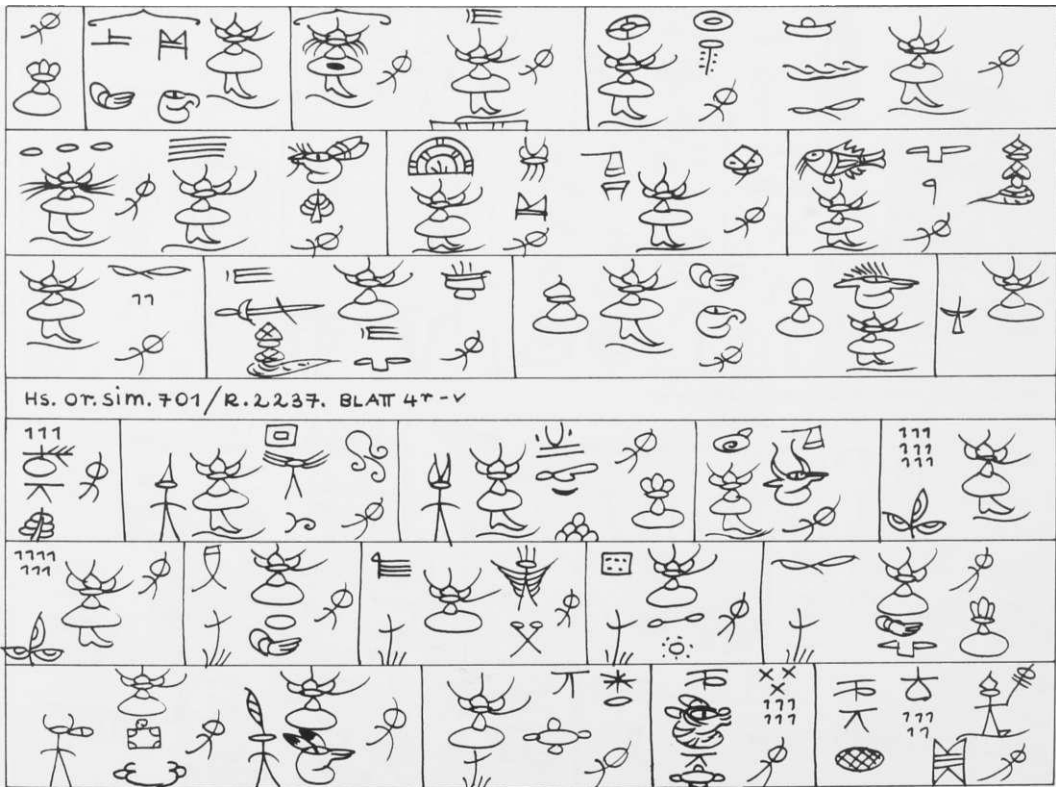
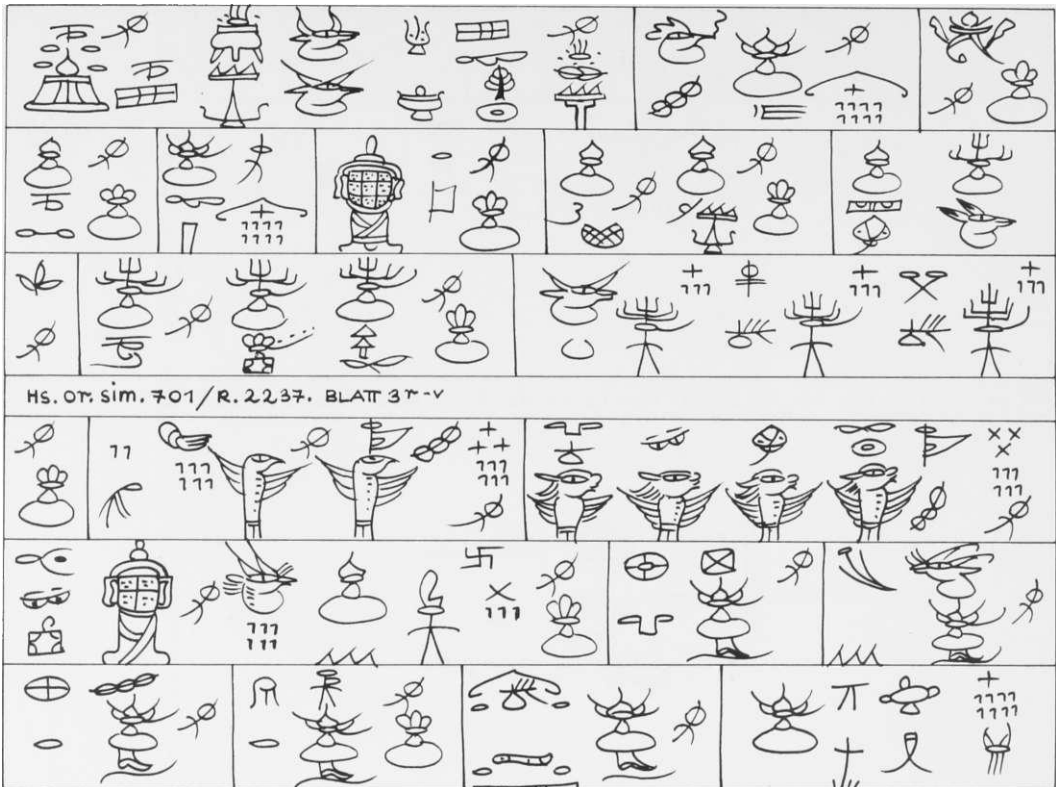

		*, \$ IS 4			
HS. or. sim. ? O I / R. iia ? . BLATT 5"^-^					
		_____ (\ £)		m	X m n) m

II					
			XXX		
			(^
^	-=*= t ± J	^	^		H ← →
Hs. or. sim. ? O I / R. 2, Z3, . BLATT (b***- V					
#	≠	^	li i-1	r-pl o n o	/ I I S
	<==V^	^	^^=3- iii		
		!	^ X _____m —<- i-ii i n	IV	^ X ^
		X ^ X	AAA		

* i t				® ^ - - ft in	
IL VL ^ ^ - ^ ^		ö ßln ^		^js *	
Ä ^				r, fei	
Hs.Or. sim.?OI/&. 222=? ÜLATT^r-v					
«äs.				iii 22 ^ #	
		^ < L E33 ^		ÄIP	
^ jto # T T ^ f l		IT ® T		N <5	

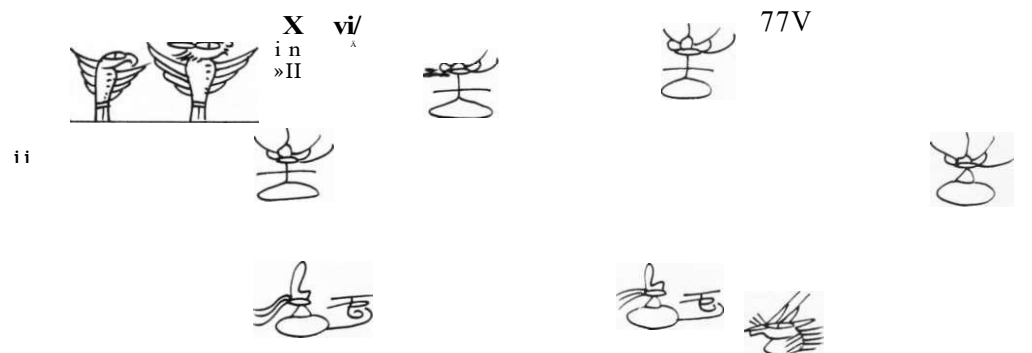

HS. or. Sim. 7-01/R. a,2,S?. BLATT 8r-v

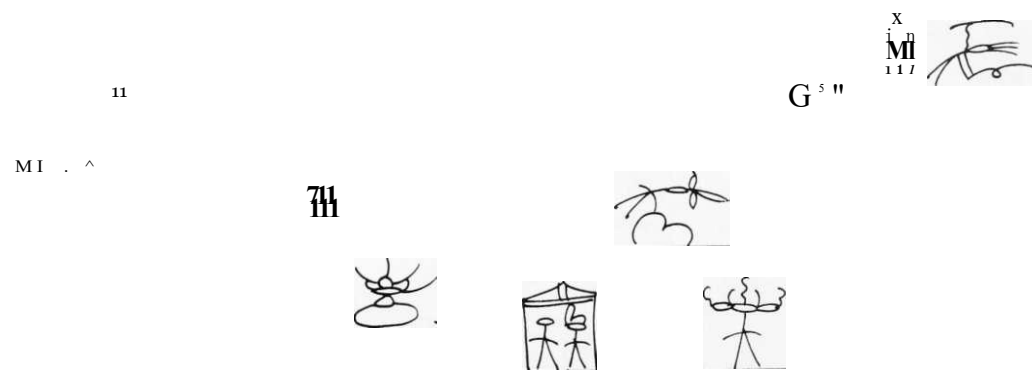

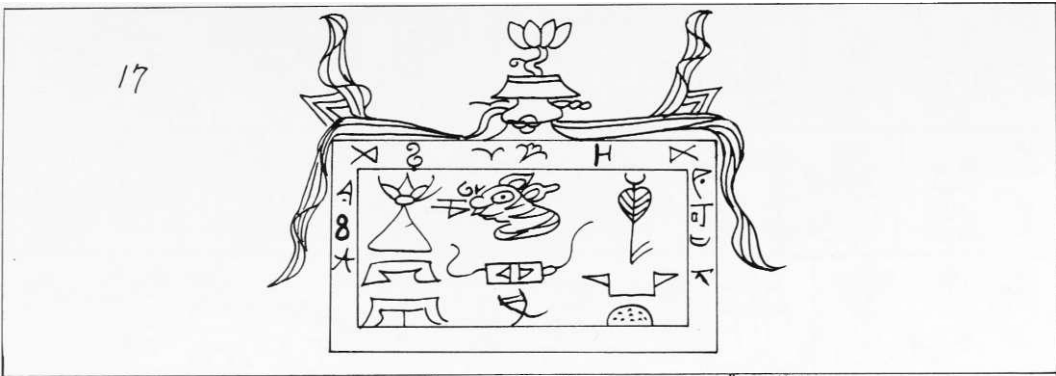

XIII, 97, r, 1 - Hs.Or. 543/R. 8238. Häṛ la-lü Kö. Du-la kv; Lü-ssī tu. BLATT 1^{r-v}
mit XIII, 97, Ec

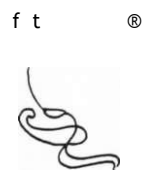
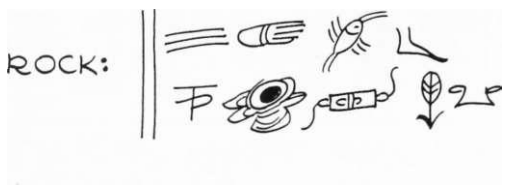

rti

Hs.Or. 543/R. BLATT ~				

2 ^

9 & >

x

HS. OT. 543 / R. 32/38. BLATT 3 >-

ni
111
111

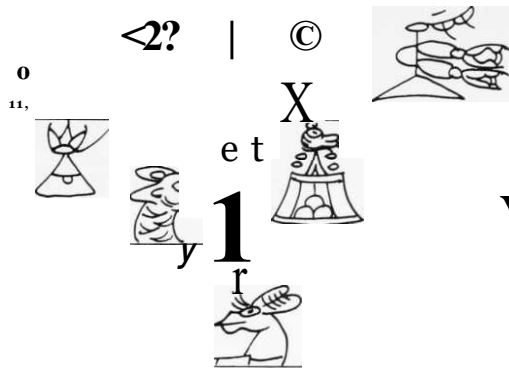

0



- 4 - , 1 . = P

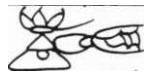

Z



HS. OTT. 543 / ft. 82,36 \ BLATT

~L^ |ij
^ | 11 0



ED



S



1

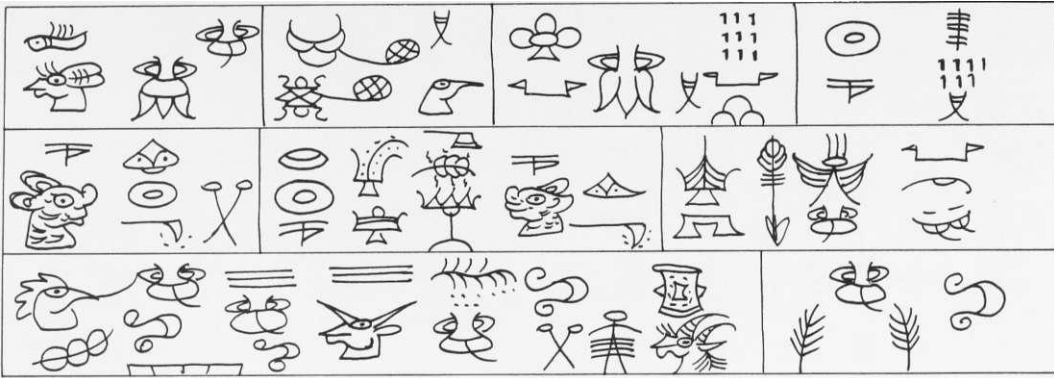

Hs. Or. 543/R. 8238. BLATT 5r-v

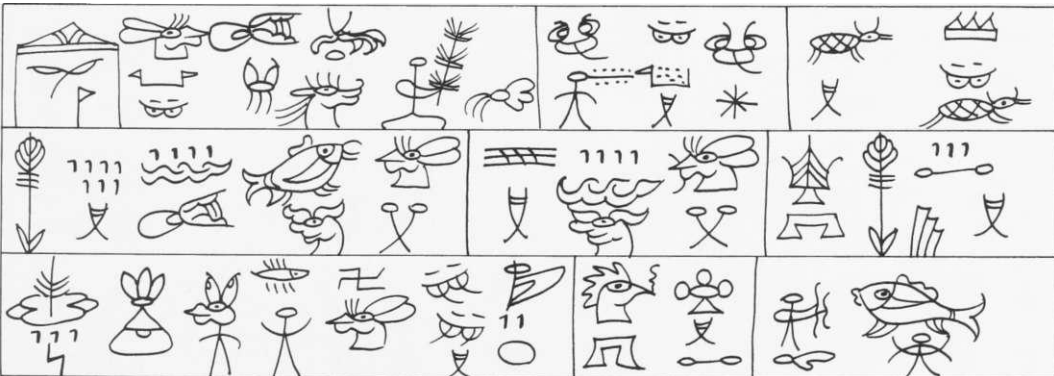
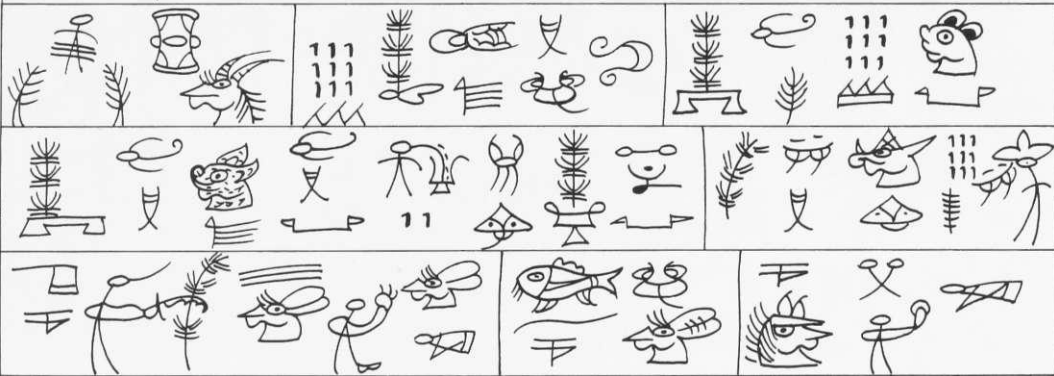

Hs. Or. 543/R. 8238. BLATT 6r-v





in



-l r



1 /V

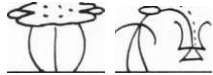

Z A

c o

HS.OT-. S ^ 3 / B . EE 3 S . BLAT



111
11



-0-



IL

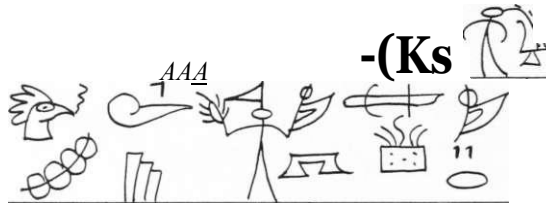

-(Ks

11



T 1 1

1111

11

11

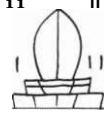

11



n i
11



1 1
CD



11 1
1 1

Hb
I

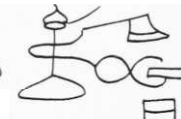

Hs. OT.SH3/K.SZ38.

BLATT

6 ^ . ^



11



1 1

O c a :

H

oo



Bö



=7



i,m
in

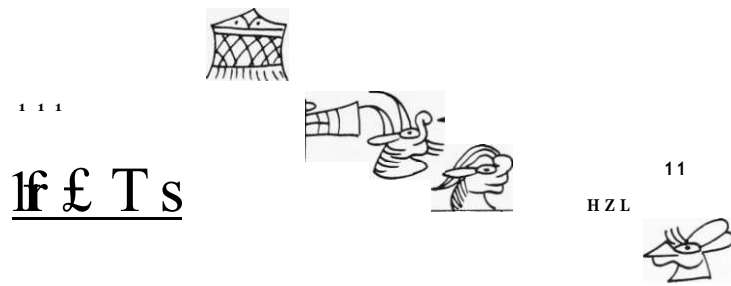

HS.Or. 543/R. S£35. BLATT 9^

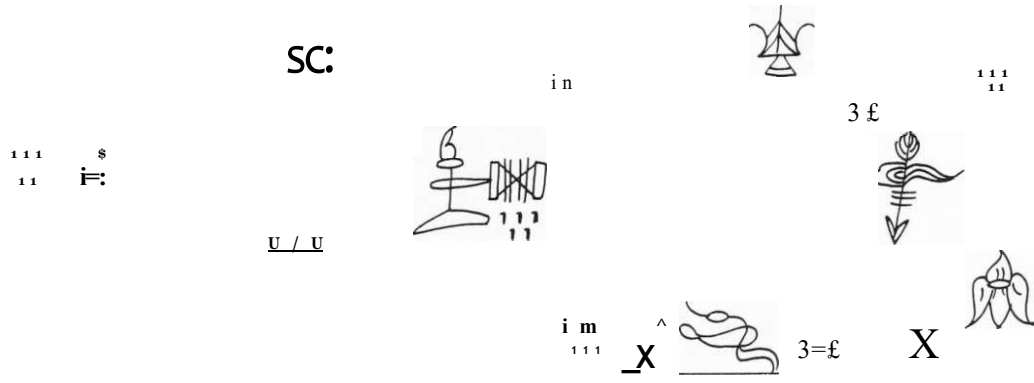

«5			
	f		
Hs.Or-, 543/R. S£3 S. BLATT 10> -v			
	1111^_ Bf -#CIJ^o^	Üb <S	
			1
1	1		

11

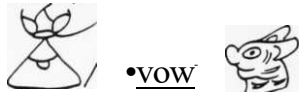

4\$ V

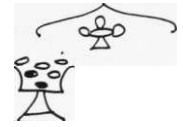

X

11

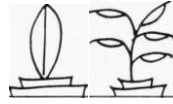

I

Hs.Or. 5^3/ K. 6^3\$. BLATT 11 > -v

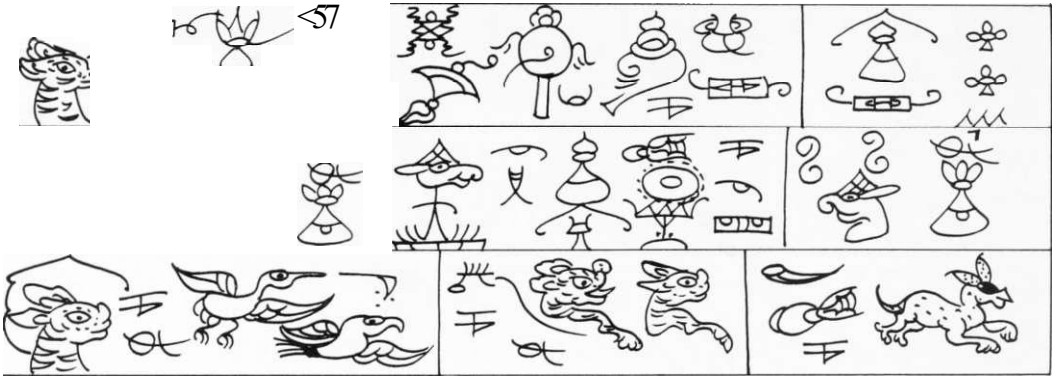

- 7 « f c r	1 - < ^ ^ °	
AUP SLATT - a / ffco-sse sr*iae.eicffa/u^q ew «y A * s IAI WOCK.*		

HS.OT-. 5 4 3 / R. o a 3 g. BLATT 12 / ^ - - u

xTir; Hs.or.sim. 5i?/R.5o-f5C. Hd> la-llii.fc!o.Pit-l<x ssau). BLATTi ^-''

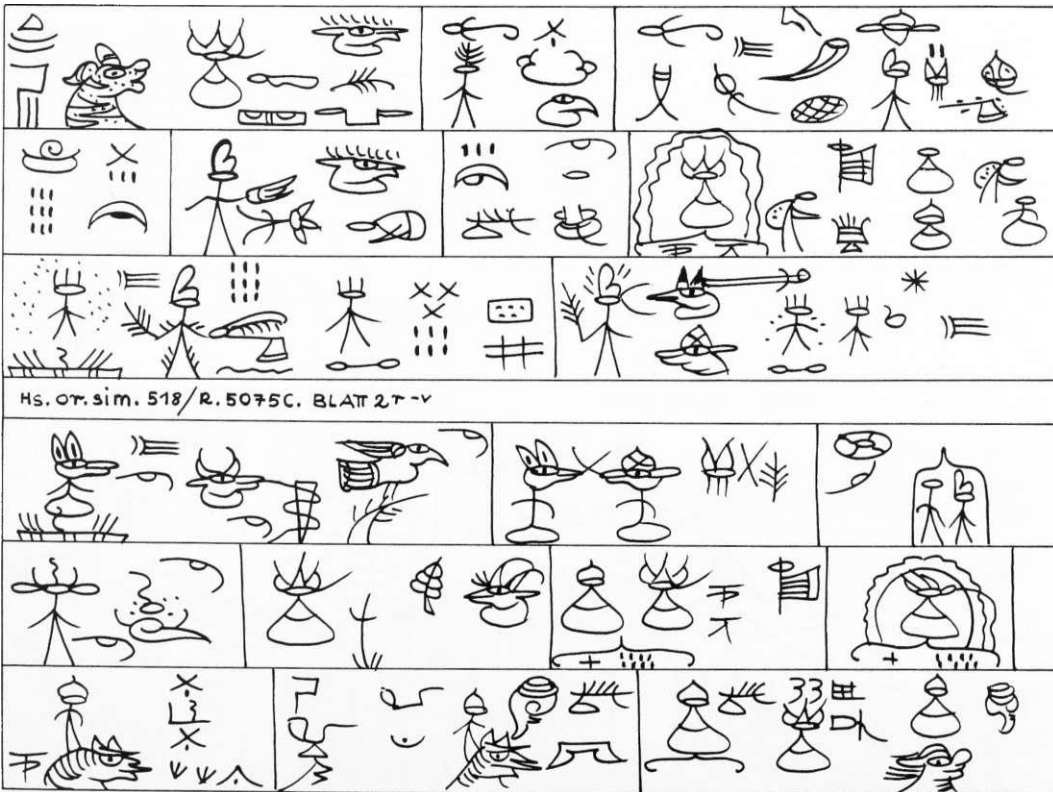
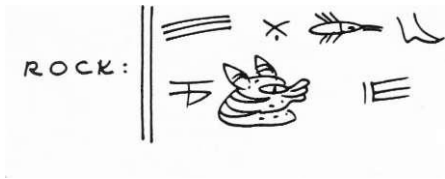

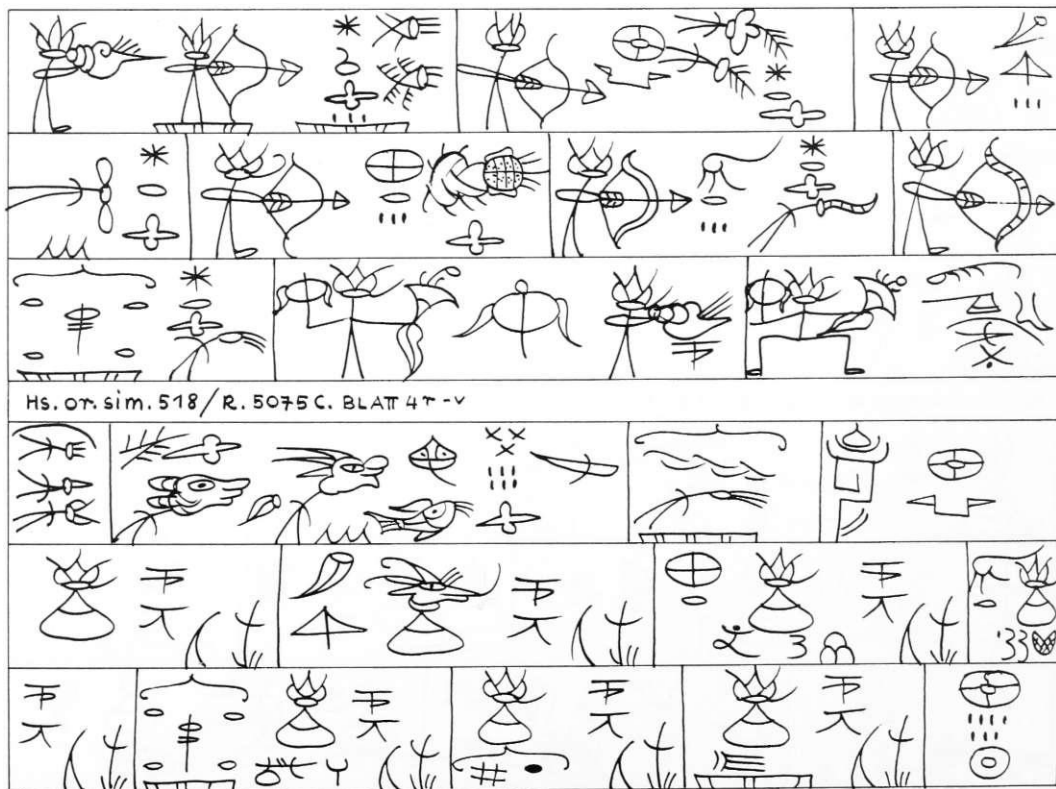
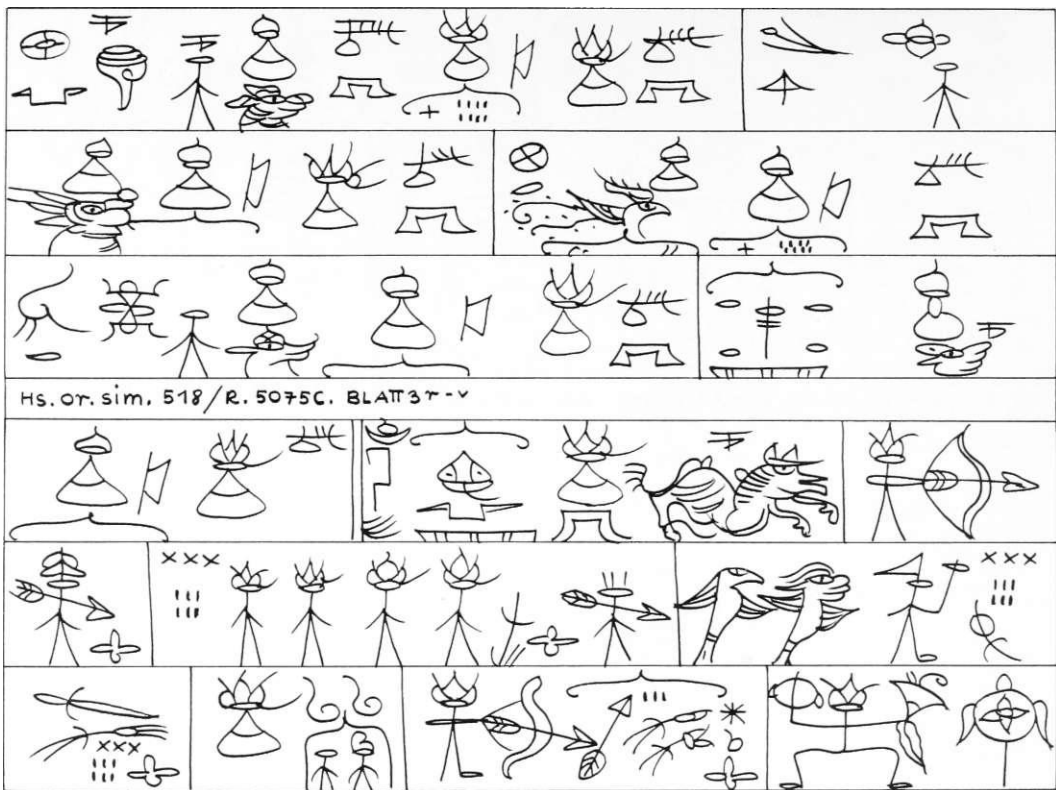

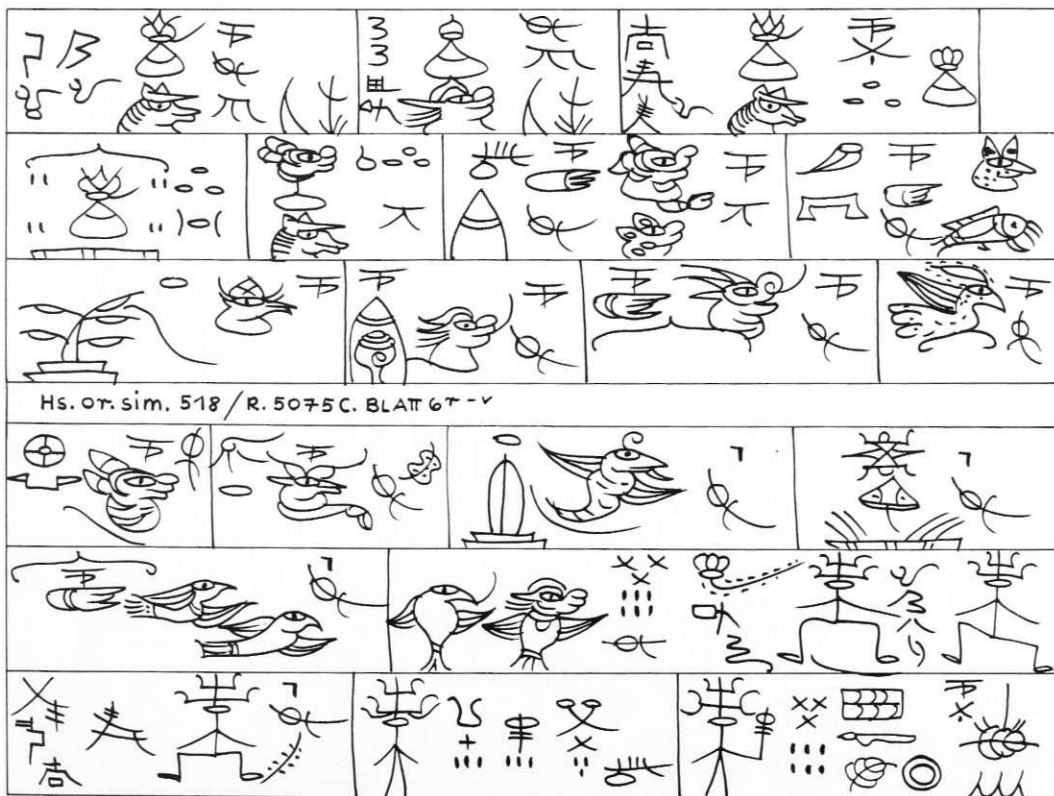
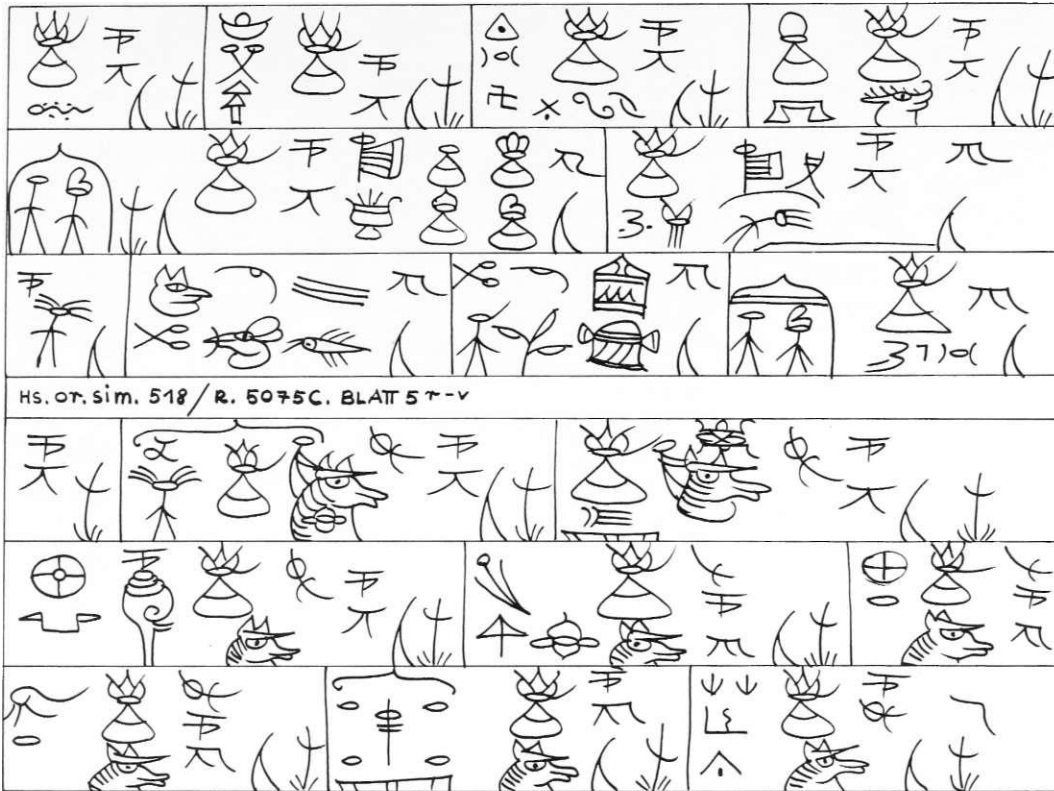

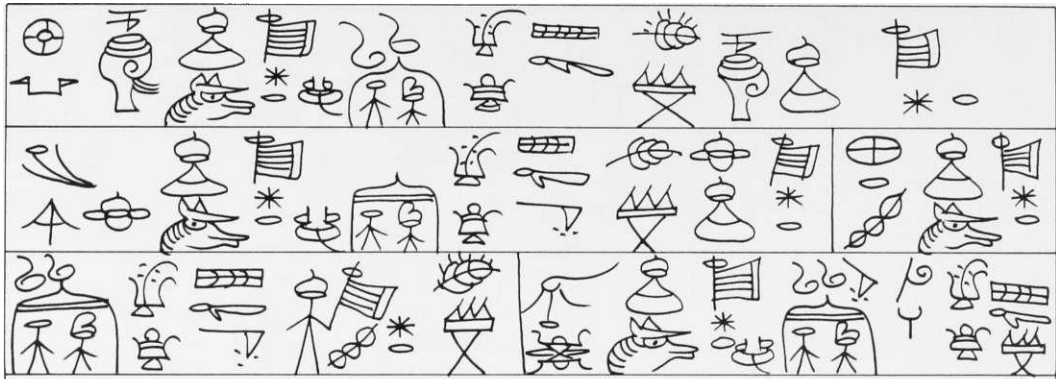

Hs. OT. sim. 518/R. 5075C. BLATT 77-v



Hs. OT. sim. 518/R. 5075C. BLATT 87-v

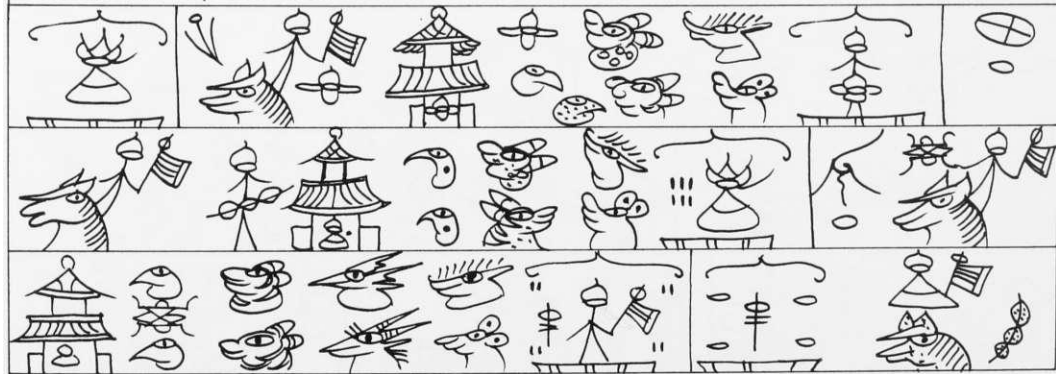

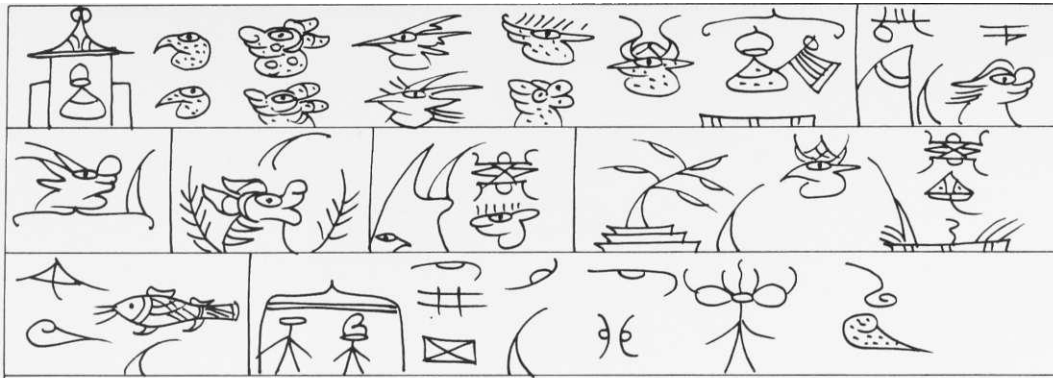

Hs. Or. sim. 518 / R. 5075C. BLATT 9T-V

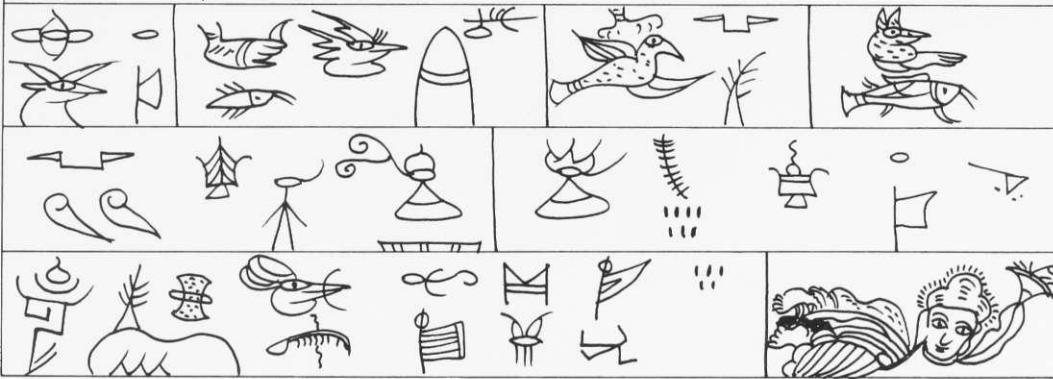

Hs. Or. sim. 518 / R. 5075C. BLATT 10T-V

xTu, 97; s- Hs.or.sim. 500/R.1150. HO.T- lcc-llü. leo. Dsho-wu.a-lu.-sit eher- diO/T'fe.hl-nolo
 ts'd-ho lüi t'u.. BLATT i -v

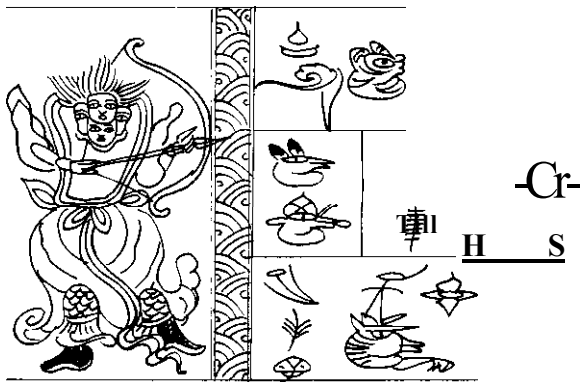

<5

HS.OT.Sim. 500/R.1150. BLATT Ä.^^^



JT? 'iii'
CS)



@ ^

^gsT



		LS]	
		x X J77J /s;/	
^	ea >	"fcS^ ' FEHLT	
HS. Of. Sim. 500 / R. 1150. BLATT 5T-- *			
X X X		® 'S X	
' ' j y Fem-T L^	1 ° -/^fSr		^ "g r j 2 ^

j p es		
HS. or. si m. Soo/R. 'i-iso. BLATT		
U		L i - - (^
<e*V ^		x 1 ^ r i ^ - ^ ^ PT

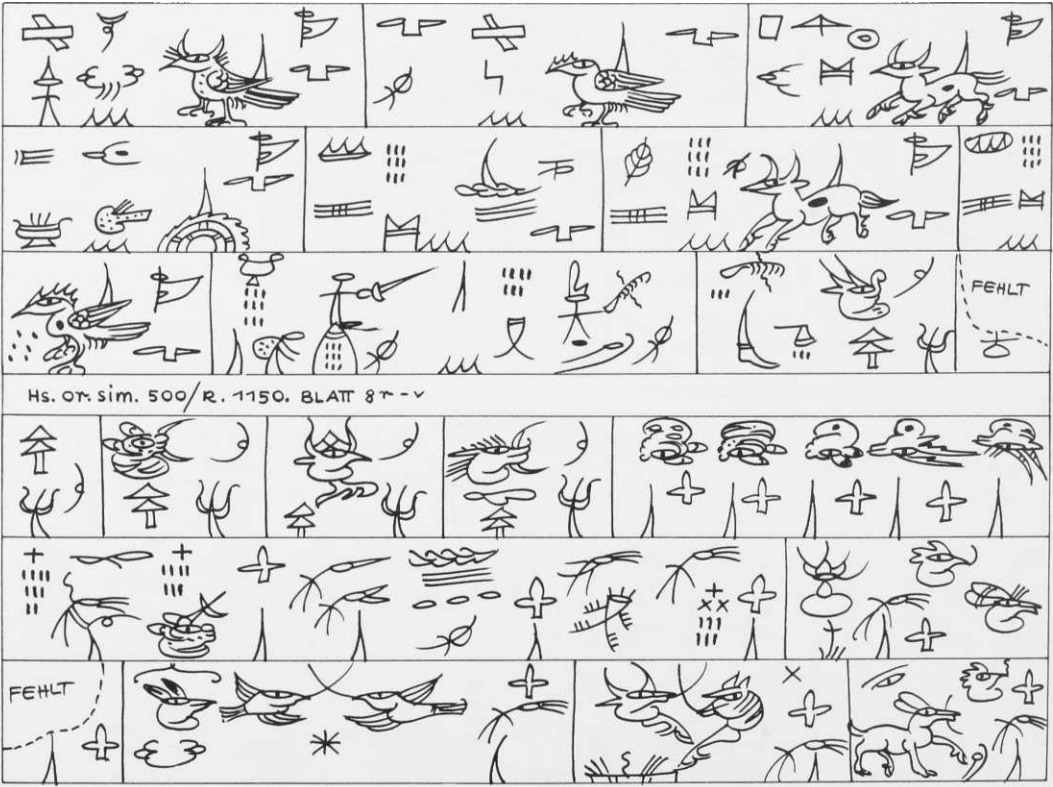
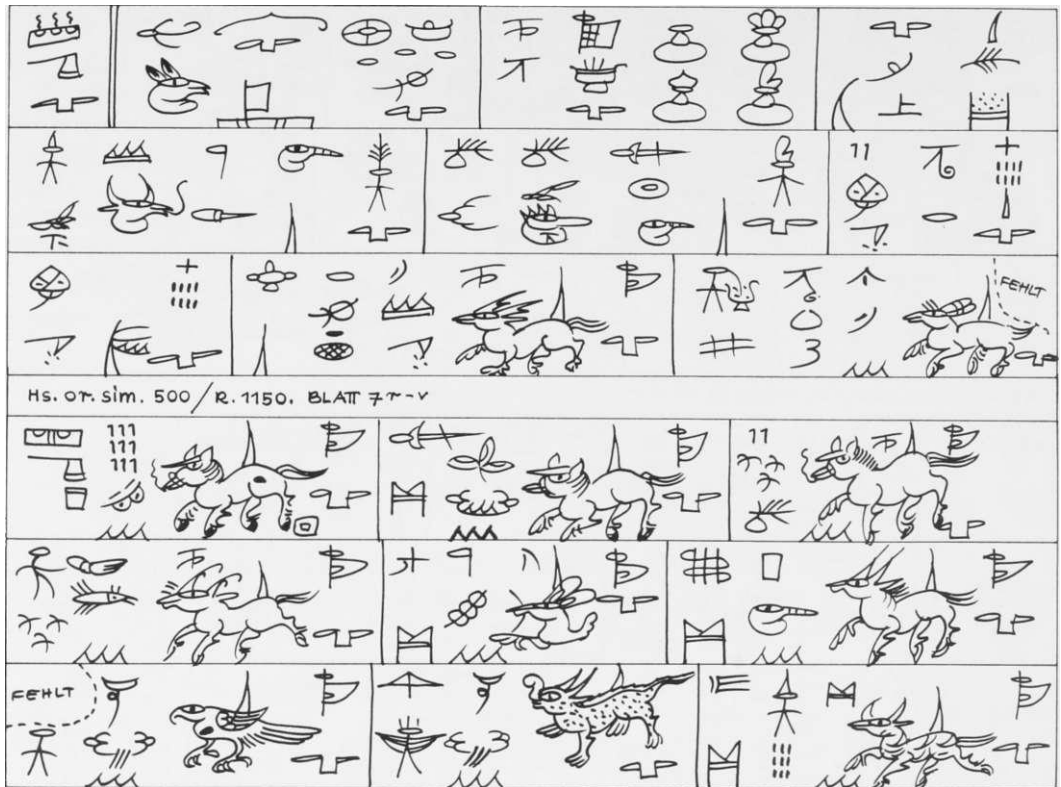

			C)C)G)	9
fg x 3	!m - j? TT ^		if	
X.				
HS.OT-.Sim. 500/R.-1150. SLATT 9^" ~ v				
			111 C ^ ^ ^ _ v	
1	1,1	^ ^		M . IWv » ^ > ^ ^ _
			-Cr-	

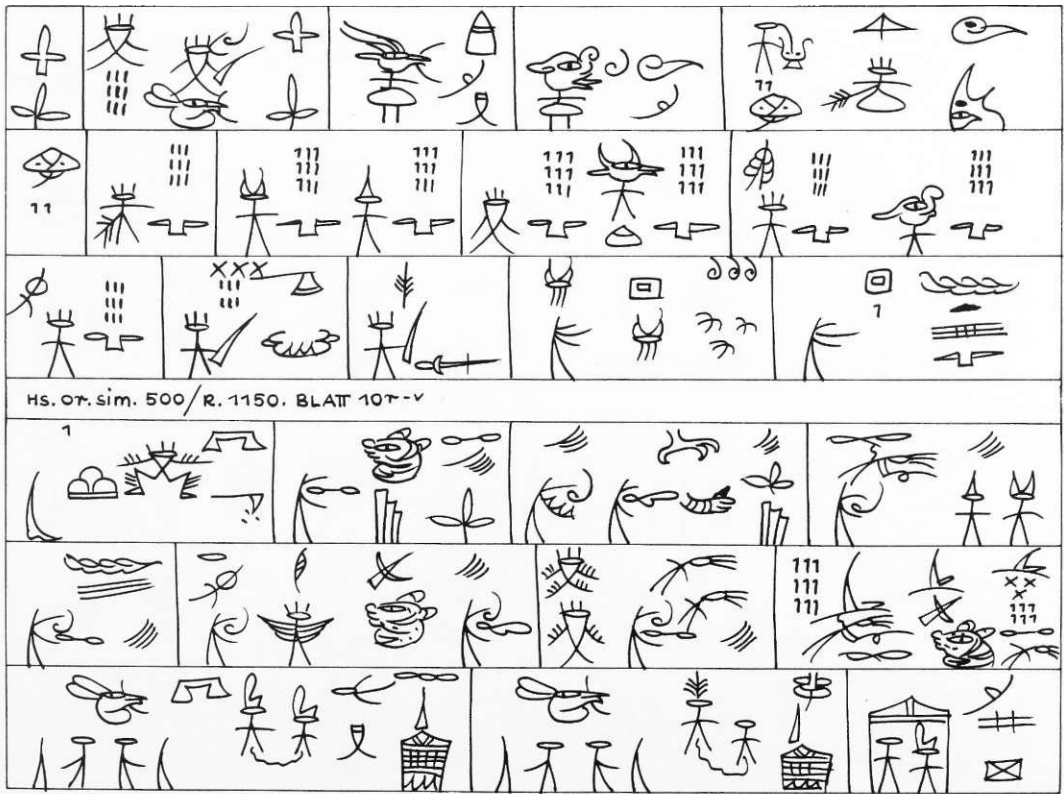

HS. OT. sim. 500/R. 1150. BLATT 10T-v

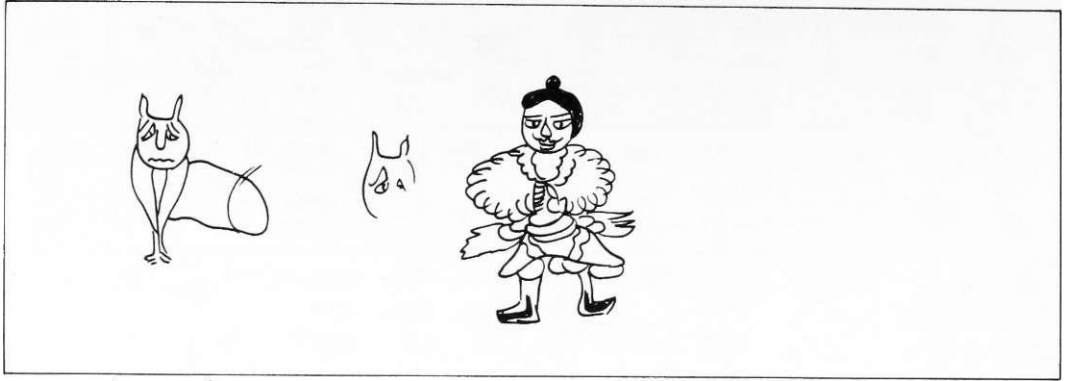

Hs. or. sim. 500/R. 1150. BLATT 117

ÖTE; 9T, s, 1 - Hs.or.sim. 519/R.so^foB. HcLr LCL-LLÜ. fc!ö. T'fehL-ndo ts'ä-ho lü. t'u. BLATT i r

--LP-



im
UM

[^]L_r /N
r

J = 3

Hs.or.sim. ff-ig/ß.. so?66. BLATT &r-v



11

0

•3.

1 0 1

A,



P⁷

#

1

1	@	 11>	.		
+	^				k ™
KU					
Hs. or, sim. 519/B. 50?fc8. BLATT 5T--V					
1		<i>i</i> '''		^	jy? w 3 IM (
		IL®			
		' x 3			
1	- tu			!	

					f f *
Hs. or. sim. 519/ R. 50?-fe B. BLATTT--v					

18

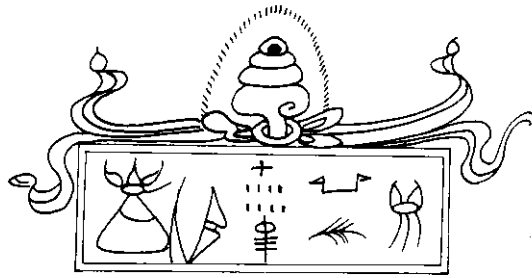

XIII, 97, s, 1 - K.OT.92/R.5024. Här la-llü kö.Tkhi-ndo tsä-ho lütu. BLATT 17-v

ROCK:



Z ^

»> B > /*\

K.OT-. 92//R.50Z4. BLATT «Ivo.

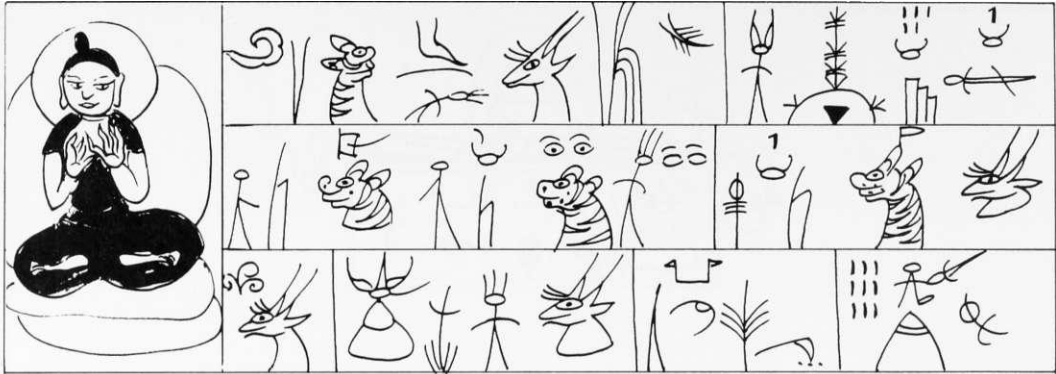

K.O. 92/R. 5024. BLATT 27-28



3
r r
U Mit

i

ii
im

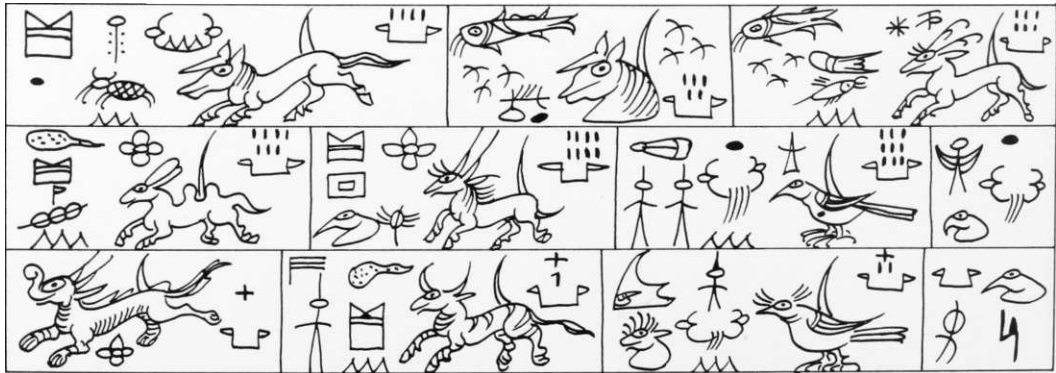

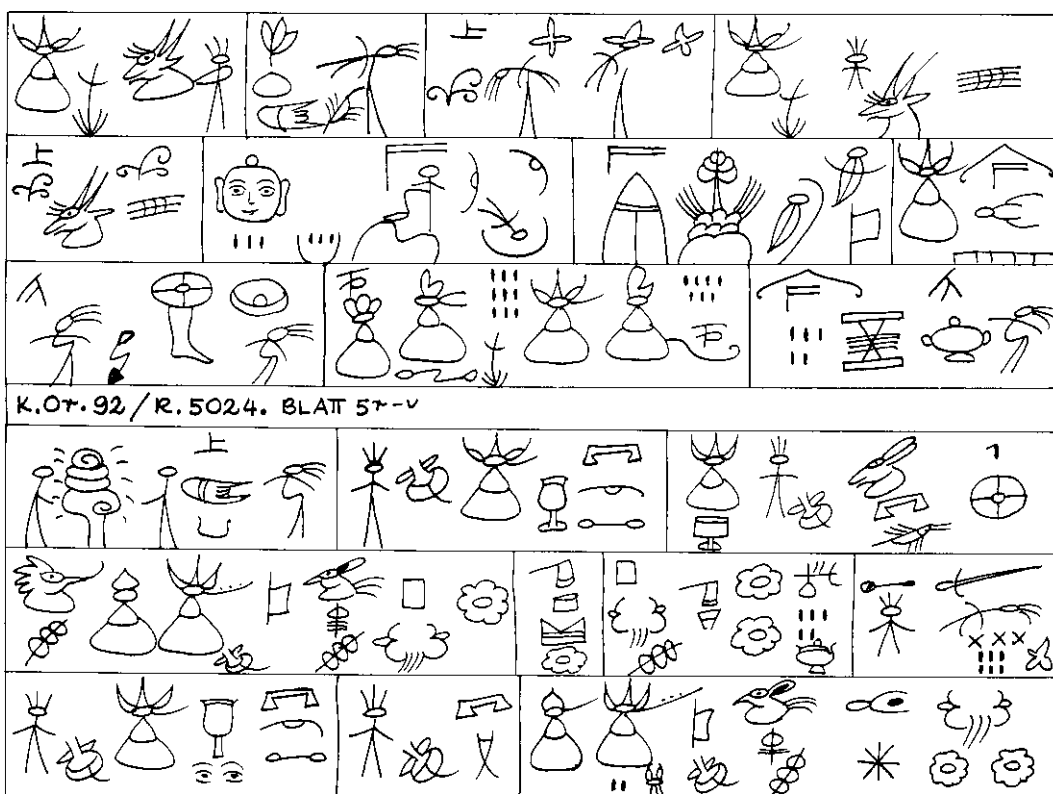
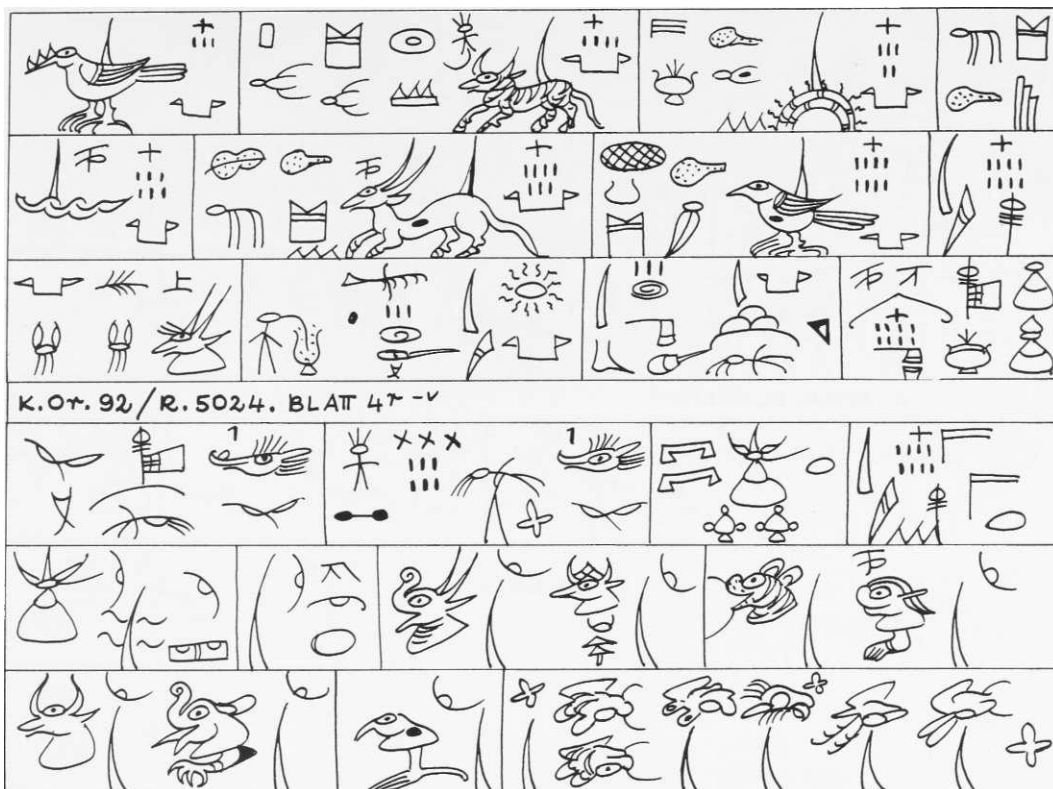

Φ UM		
$:\langle Ei \rangle:$ \dagger nil $\dots \langle D? \rangle!$ \dots X	$-z_r$ C^s	

K. Or. 9Z / «.50M. ÖLAT S^

18

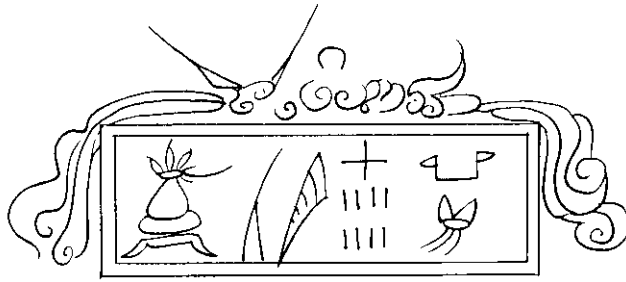

xii, 93, k, oder:

XIII, 97, s, 1 - K. Or. 214 / R. 8216 B. Dto kō H&T kō. T'khi-ndo tsā-ho lū tu. BLATT 1r-v

• == 55

R.OCK:



- j -

IUI

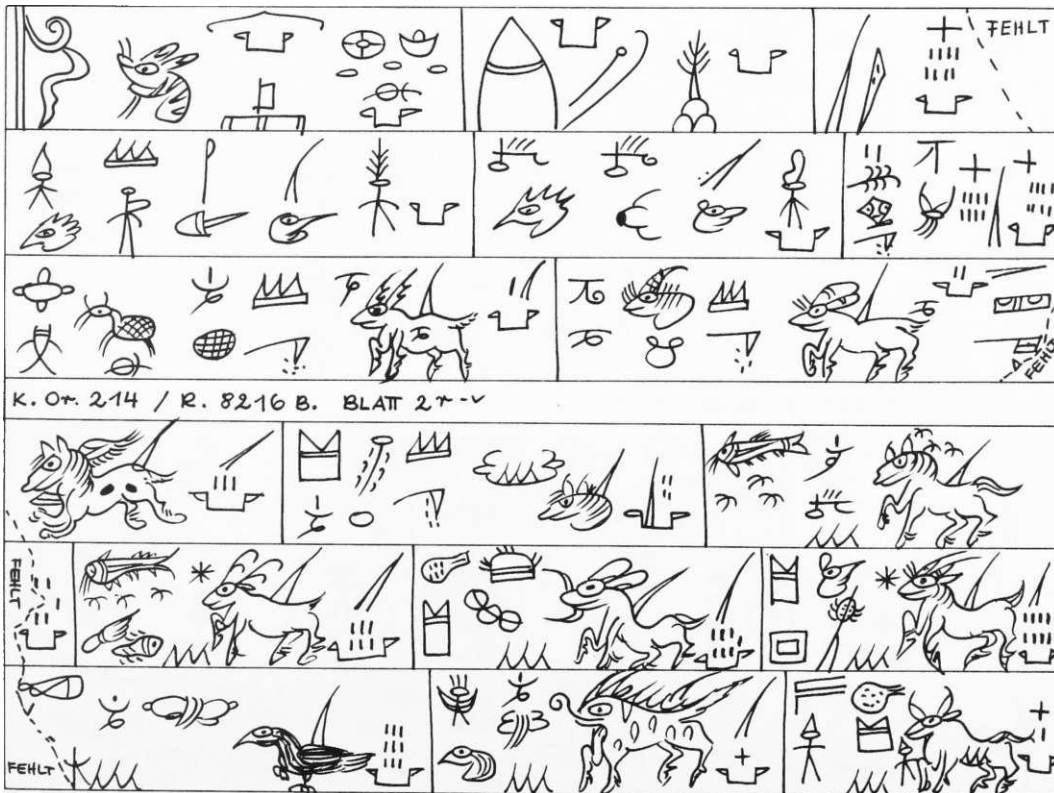

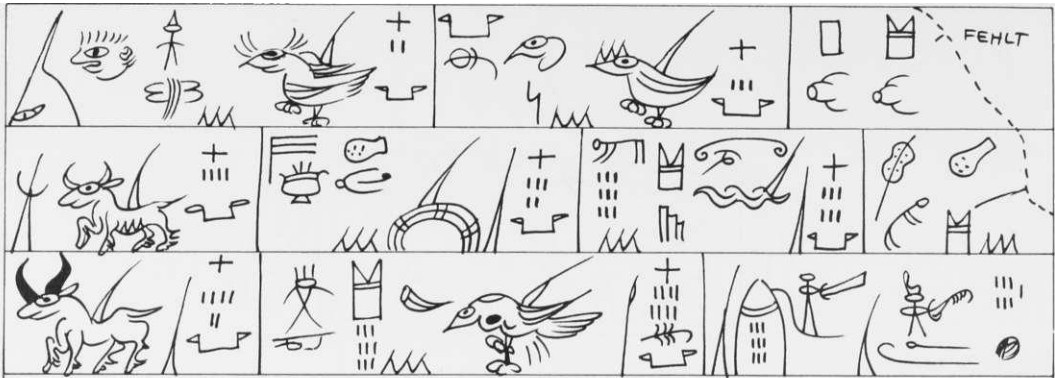

K. OT. 214/R. 8216B. BLATT 3^{r-v}

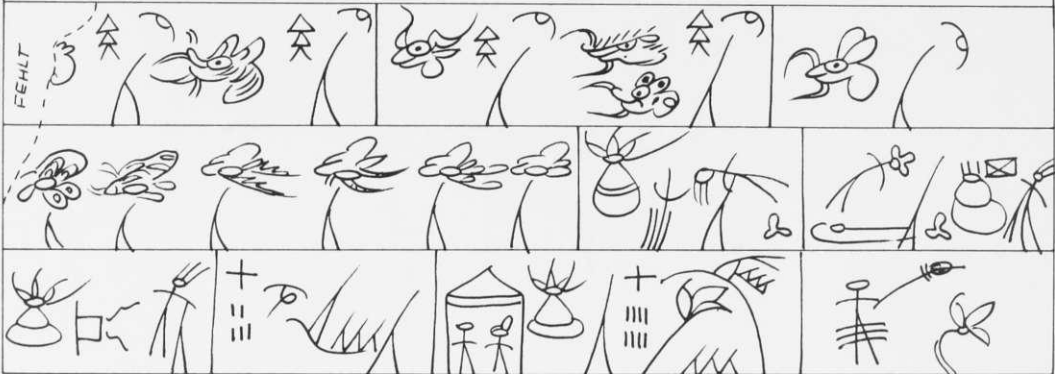

K. OT. 214/R. 8216B. BLATT 4^{r-v}



	5 ©	age	
SP		<i>Tik</i>	-

K. OT. 2,-14/B. S^-lfc 6. 8L4TT 5 ^

19-

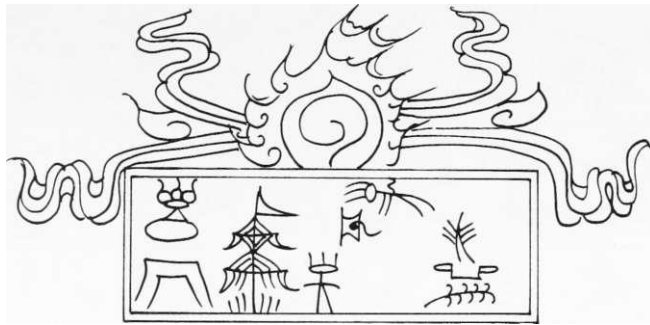

Hs.orsiw.fc6f/B.3006. Har-LCL-LLU. fc6/JsU,ts'u-Jcu, pu_. BLATT - I - * -

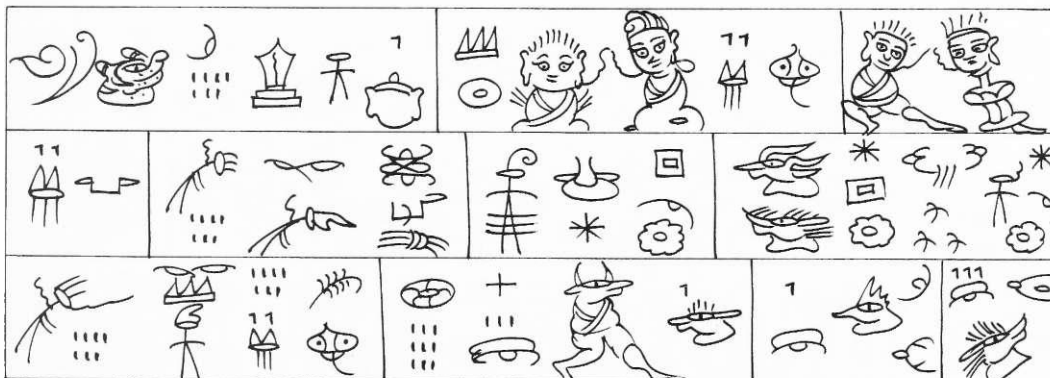
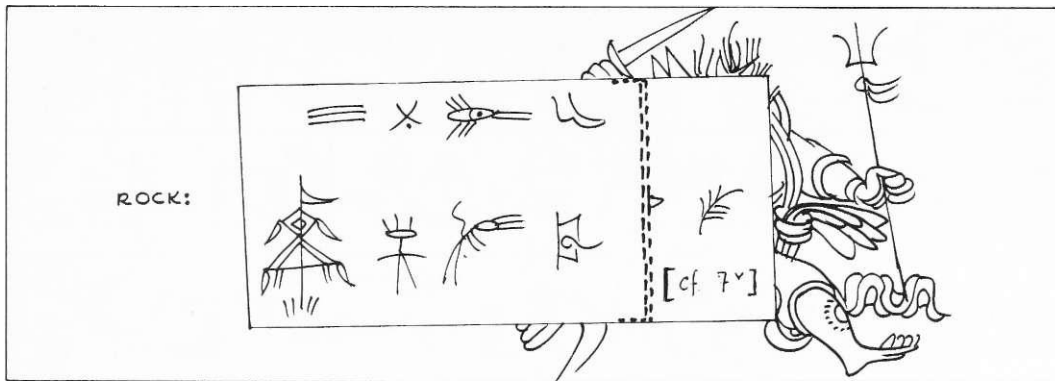

Hs.OT.sim. 628 /R.3006. BLATT 2 * - v

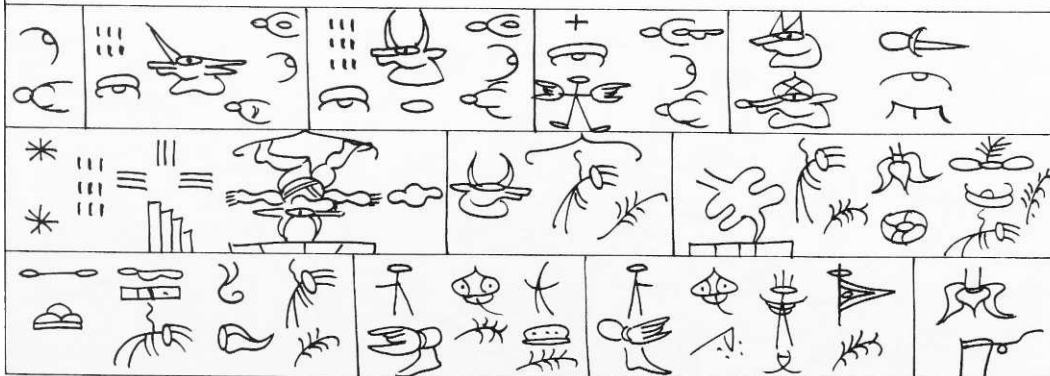

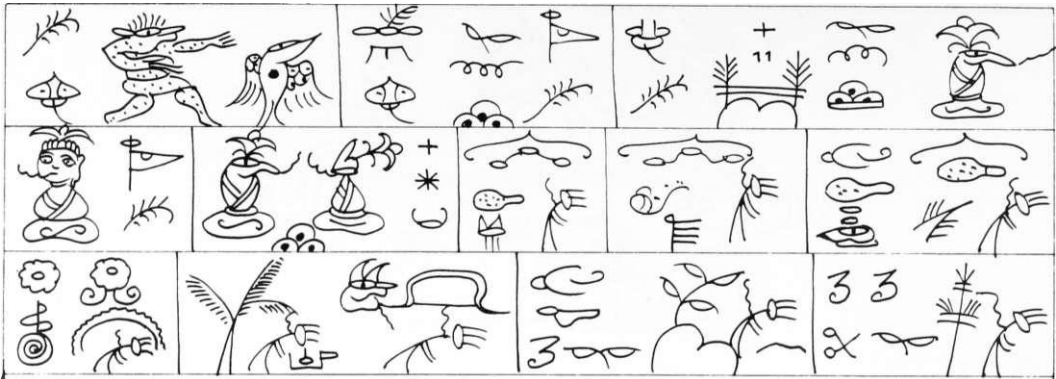

Hs. Or. sim. 628 / R. 3006. BLATT 37-v

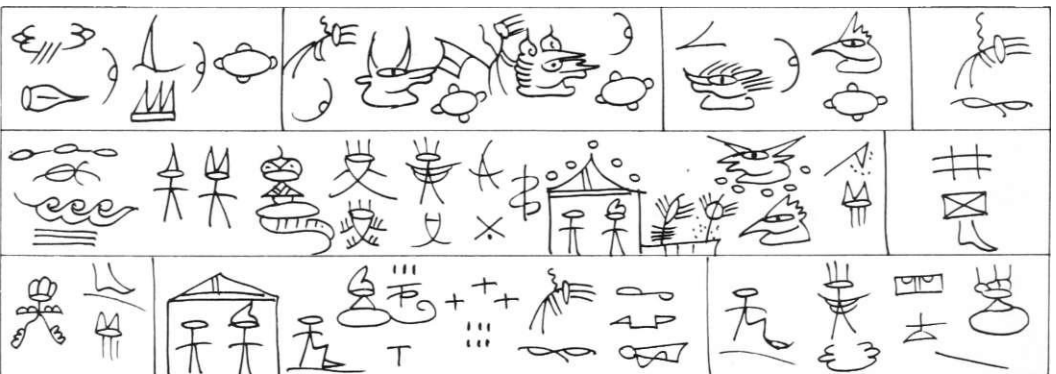
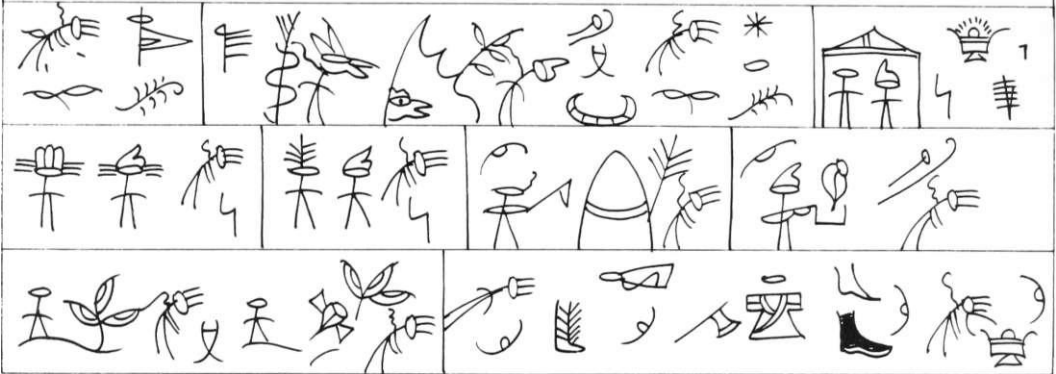

Hs. Or. sim. 628 / R. 3006. BLATT 41-v

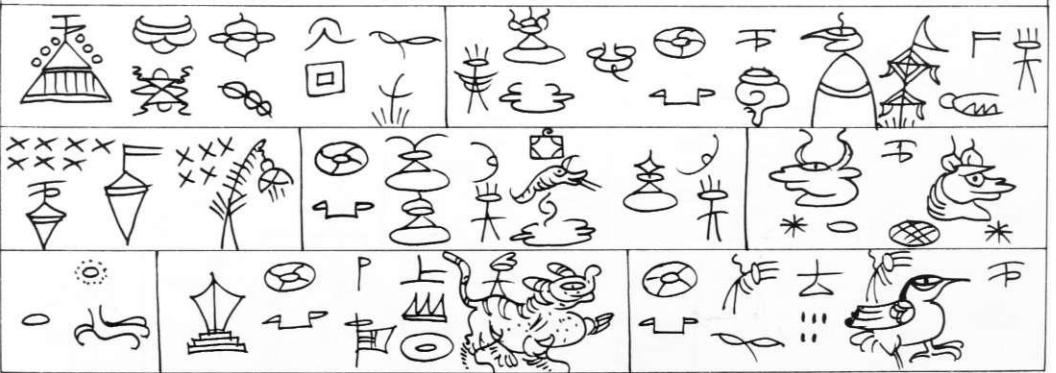

			C=L M "I L U " ' W
			10:
iHs. or-51V. b&P/B.SOOfe. BLATT			
			ft
F=			** .11 11
9 * >>			ft® ^ /x

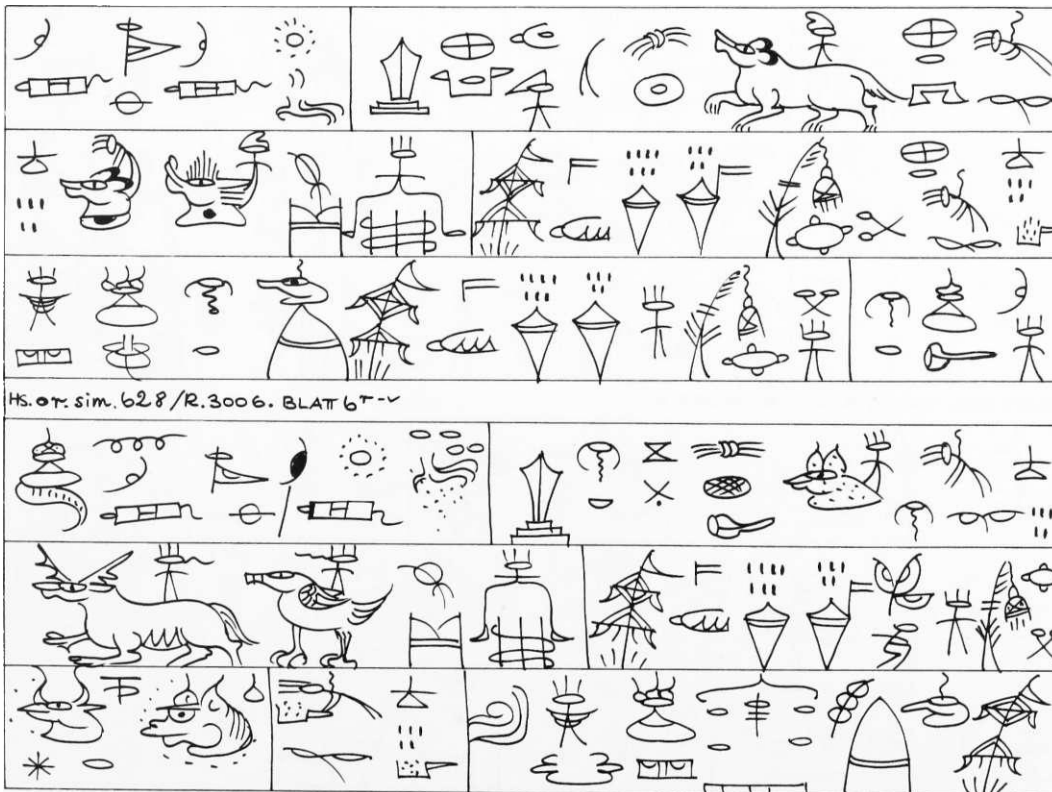

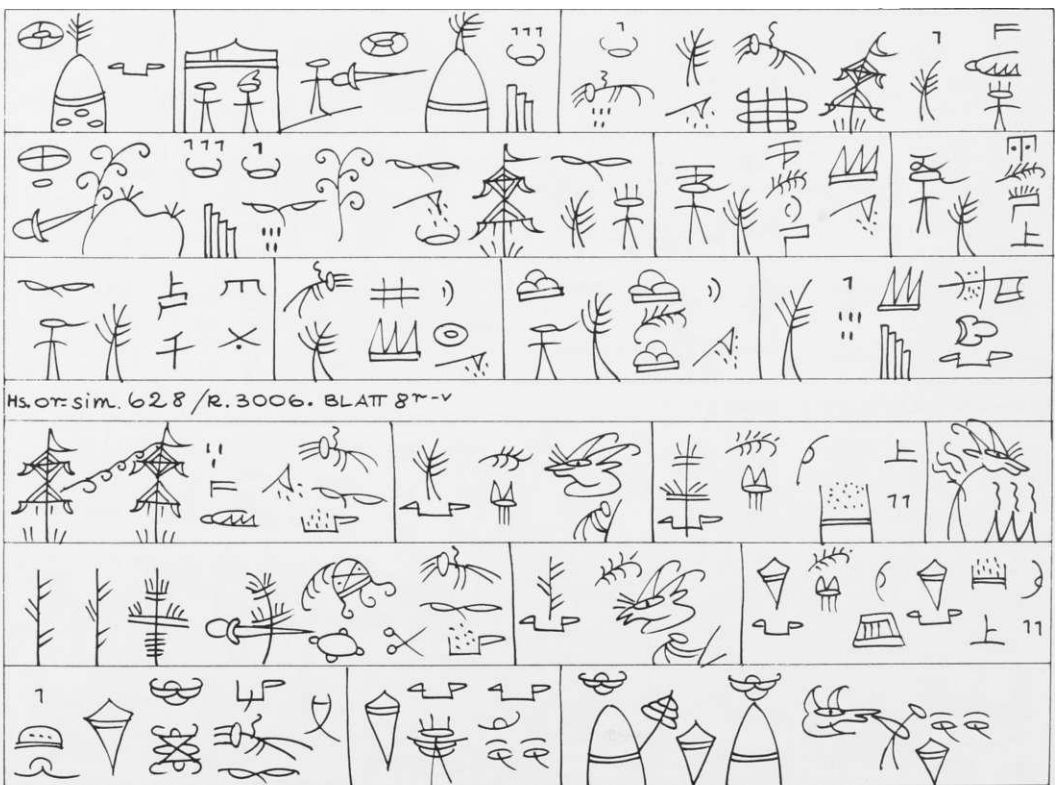
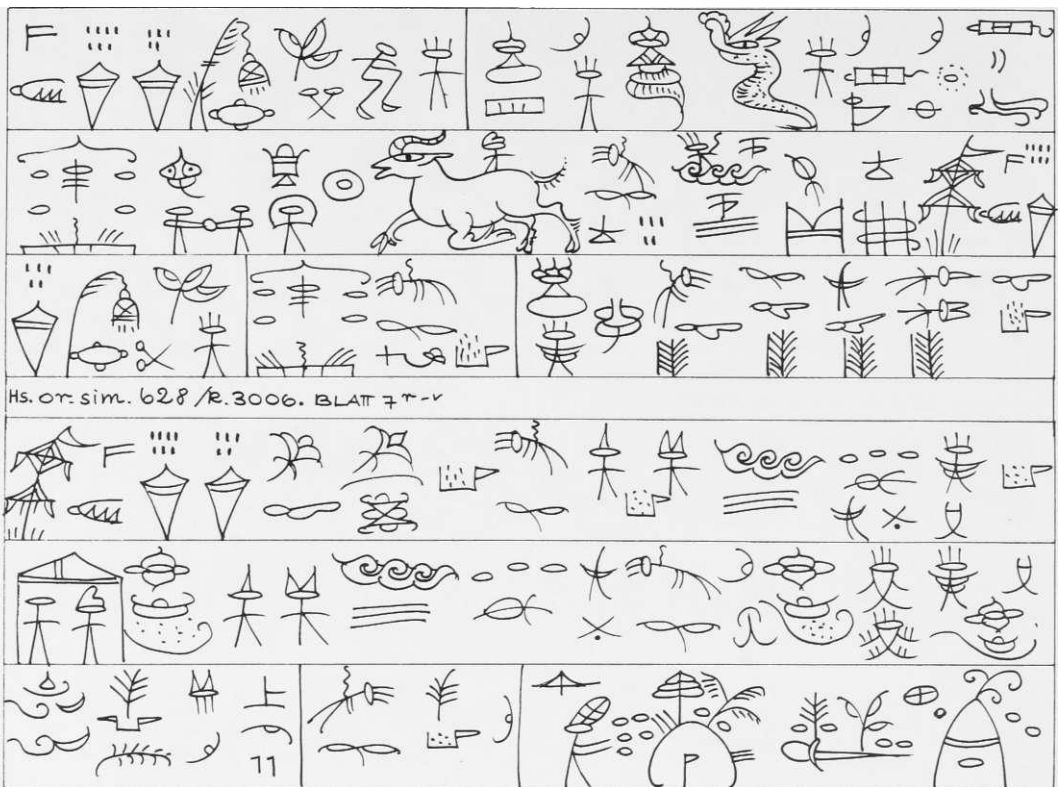

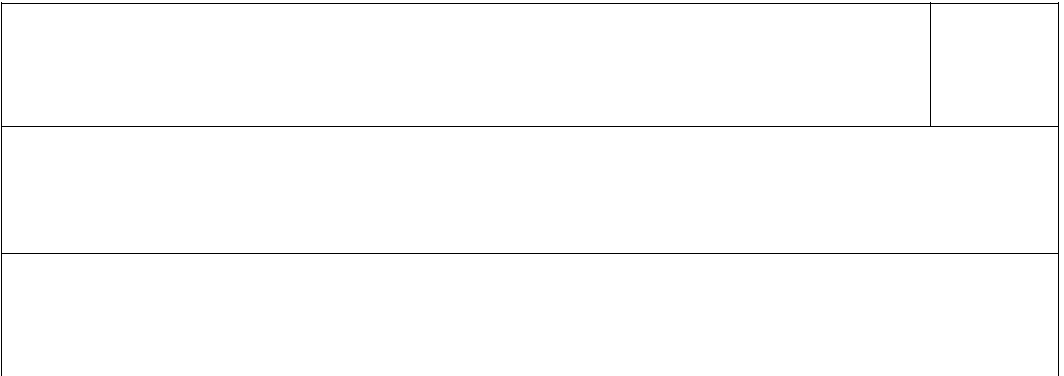
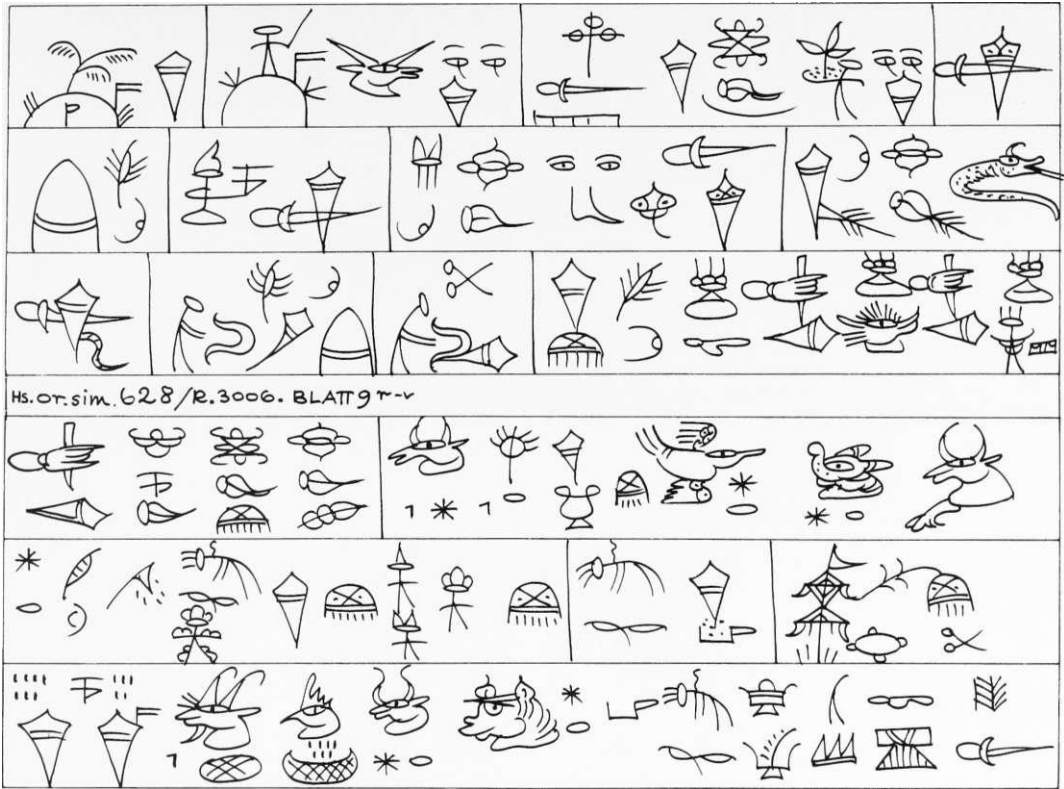

Hs. or: sitvL. bE.?^/B. 300b. BLÄTT 10T-V

xm, 1 - Hs.or-.sim. 5og/R.i?90. HOLT- la-llü. telö.Ts'u, Üu. p'u.. äuATT i** - v

ROCIi:



DC X	*		4i

5 /

Hs.oir. sim.509/»e.-19-go. BLATTz'":'	
	4 ;y %
<i>i</i> > t ^ q * o ^ T > T ^{y3} Nr	
l ^ j ^ / r ^ S ;fe T ^ ~ f F	

$\circ^{\wedge} \text{") } z . i = V >r \wedge F A$	
	$\wedge \wedge Hi. \circ \circ X$
<small>HS. Of sim. 509/B,. -i^go. e.L.ATT3''''--^</small>	
iff $\wedge X T p 3$	
	$x y > f e T F 3 b p$

$\wedge i$	$f l \wedge_3 \wedge$	$\triangleleft A ' _3 TG$
$y \wedge$	$\wedge f >F \wedge X \wedge _$	$\wedge \wedge Tf \pounds$
<small>Hs. OT\ sim. & 09/R. 19-90. BLATT 4^ - *</small>		
$\wedge >f F >i$	$x f$	
$f "1 \neg p >f -ff- ' _3 >r$		
"TF "TF $>r$		

x 4	^ ^ 't' € ^ ^ ^ / ^ . > ^ ^
	Mf Jt
>V 7V ^ 4" ^	
A" -ft-	J c >r ^
go >V ^ O r e L ^ S£	4 f £U
HS.OT-. sim. 505 / B. 1^90. BLATT 5 ^ - "	
f)f ^- f- f ^	
^	^ ^ ^ 3 f. ^ v
>f S _ ^ ~ ^ r^3 Jr->	

2,		4 H -
3 ^		f
^ >r ^ ^	>f κ H	f
Hs. or-, si m. 509/n. 1^90. BLAT fc-r-v		
	^ ^3 H 5? 5?	

		r *L y l f
π 5l? f		
Hs. OT, sirrv. 5 0 9 / 1 ^ 3 0 . BLATT ^ r - *		

l	>r f ^ R ^ ^ J# 7^ to	
Hs. OT-. Sim. 5 0 9 / R. -1*90. BLATT 8f-		
	> ~ hr f	
^ %	^ ^ "T	

^ >to _u_ ^ y Jb	
HS. OT-. sim. 509/R.. 1990. BLATT 3 T--v	
^ :)r	^ i 7^ ^ f ^
	3 ^ h - „; £ ^ ^
-5 - A % §	
i=s_ ^ > r	^ «y dz »>> Lk

7^ ^ ! t?	
rr	K 7-j ^ y ui.
^ ^ ^ ^ ^ r n a ^ 1	
^ T ^ ^ ^ T o°o 9 ^ >3	
HS. Or.slm, 509/R.. 1990. BLATT 1 OT--v	
1 x f h-	
	>ET x H X f
/ = ^ ^ f ^ Y ^ 35 " t 3 \	
r- ^ ^ 1 ^ ^ ^ ± ^	

A 9 ~ >r % i= i	
/ C X)	% o £ TT ^ ^ >f 7 ^ T
HS. OT-. Sim. 509/ft. 1*90. BLATT 11*- -V	
f 3L \$ r ^ ^ i ^ ^ - H ^ ^	

X JL ^ >>>	
HS. OTT.sim. 503/B. 1^90. BLATT 12/^**	
	- X ^ T X ~^T>hp
	T T X T X ^ U s ^ x u 7* .--
	X f>r > ^ ff

				4 [^]
T	P	M		
HS.OT-.sim. sq [^] ya.i [^] o. BLATT-IST-- V				
	y	ft [^]	-f	
- " ") * > "H V Y - ' & ^ 7 ^				

7' y/s+r \p J_ 4^ ^-ife
di

* 3 ^ ^ ^

Hs. or. sim. 503/β.. -1990. BLATT 14^{^-^}

f ^ yjv < ^ Ä **9** ^ - 7,* y//, x z/ ^ /



i ^ g - so f y ð ^ g ^ f f ^ ^ > ^ / r i

Hs. OTS sim. 503/«.. i=K90. BLATT-IST-

X 1 ^ » ^ 32_ Jt - ^ j-L. ^ -

HS. OT- sim. 505/B.. 1T-90. &LATT -Ib'''

TITeLBLATT FSHLT

xm, 91, u. - HS. or. sim.511 / B . 13^5. H2L> ICC-LLÜ. te.o. tct-llu. noU&r- ts'u.; Ts'u, te'u. pu.. BLATT-1*

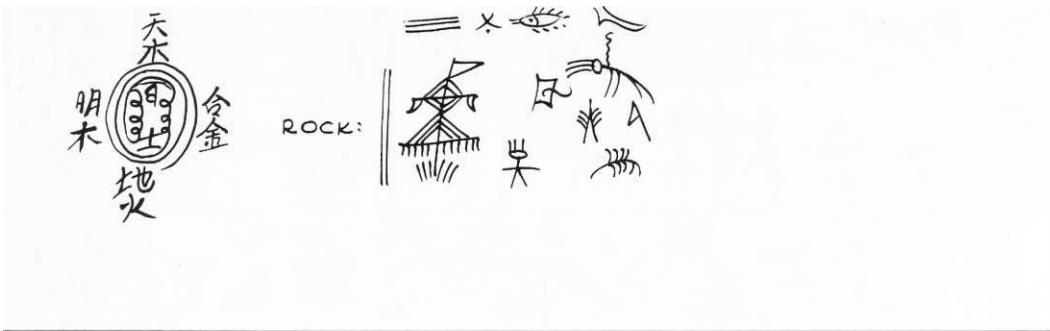

Hs.or. sim. 5-II/fc.1915. BLATT 2 ^ - ^

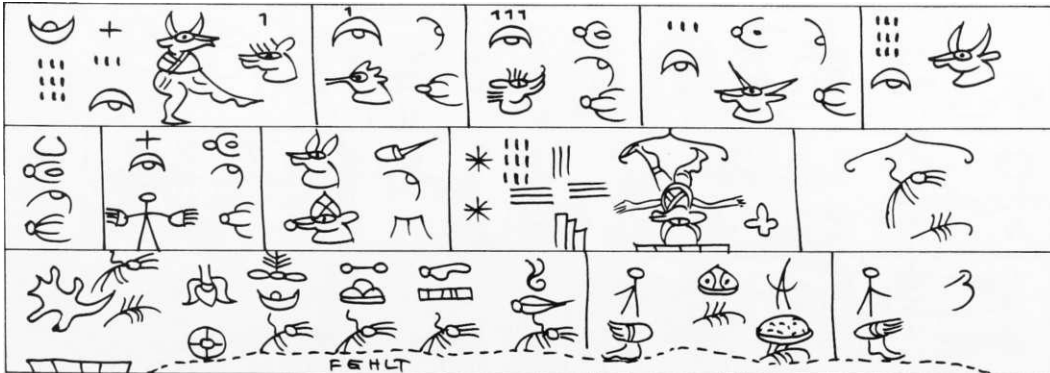

JL

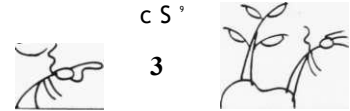
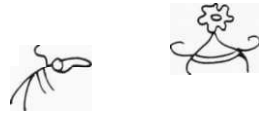
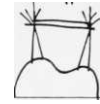

Hs.OT-.sirn. 511/B,. 1915. BLATTS^'



X



0=

"3

[# -a

H7 1 ^ 3

AAA 7 3.

o X
PTN
H S

4* H

X

X . S



HS. OT-. Sim. 51-l/R.. 1915. et-ATT^i'-



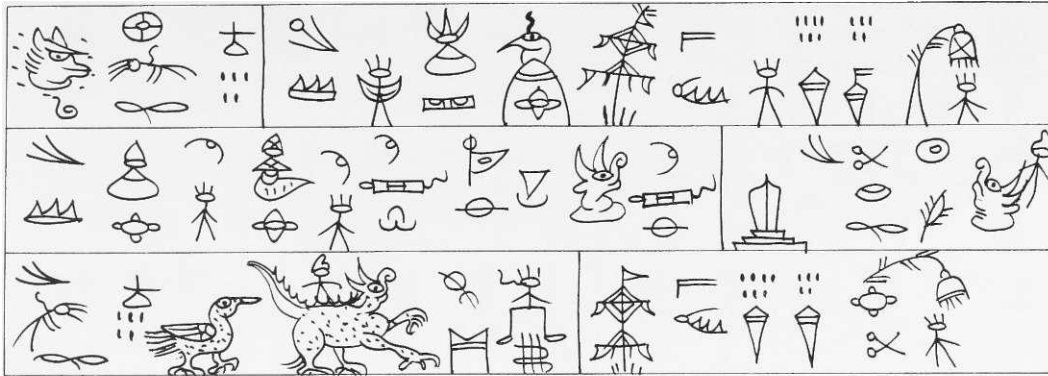

Hs. or. sim. 511 / R. 1915. BLATT 5^{r-v}

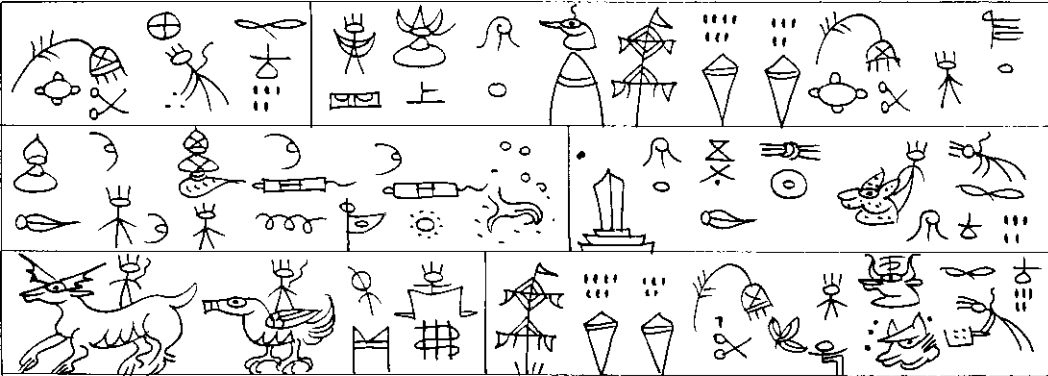
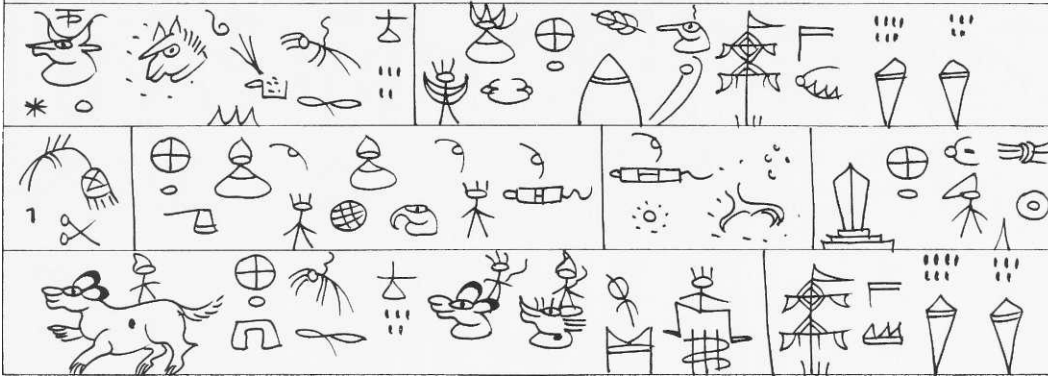

Hs. or. sim. 511 / R. 1915. BLATT 6^{r-v}

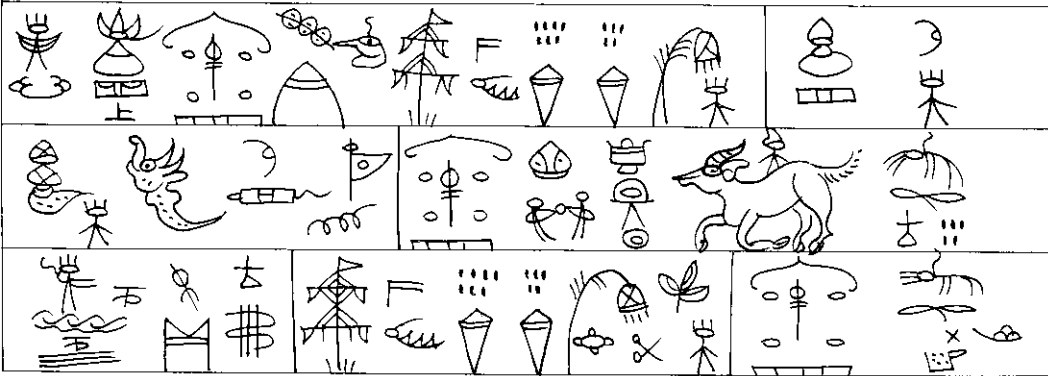

<CZ> ce=s 00= o ^ ^ ^ % W WWW		• I# # X if/ W
IUP - ^ v *		, If ü — ^
HS. or. sim. 51-I/R.- 19-15. BLATT ^ T -- V		
		-ir-, ® ^ "' /o ° 1
X A	? * 4	

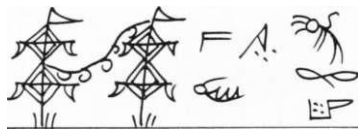

i

-LLP w



d" ^ *

1

3 . .

Hs.OT\sim. 5-11/ft. 1915. BLATT 81"-*

T T



T T

X T

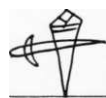

3

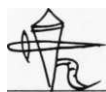

% Y V ©	
• ii» *1 IC ik o	
Hs. or. sim. Sil / £ . 19-IB. BLATT 9 >-	
	j - ^ ^ . j T V H

22a.

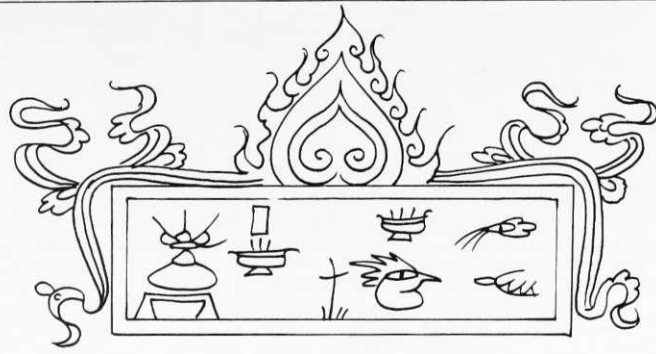

XIII, 97, w, 1- Hs. or. sim. 591/R. 1190. Hār la-llü k'ö. Dto bpö Wu bpö; 'A gku hü. BLATT 17-17

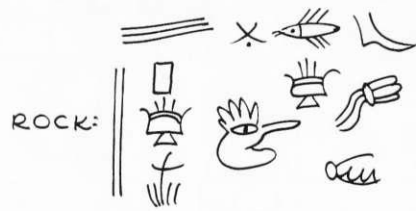

				+	
	,1				
			5 X		
Hs.OY-.sim. 591/ft. 1190. BLATT					
		US XX		- s ~ ^ / J	
			XXX	A A	r-r, —, —,
	X 0		^ w		5 *
	1		^ /	XXX	"

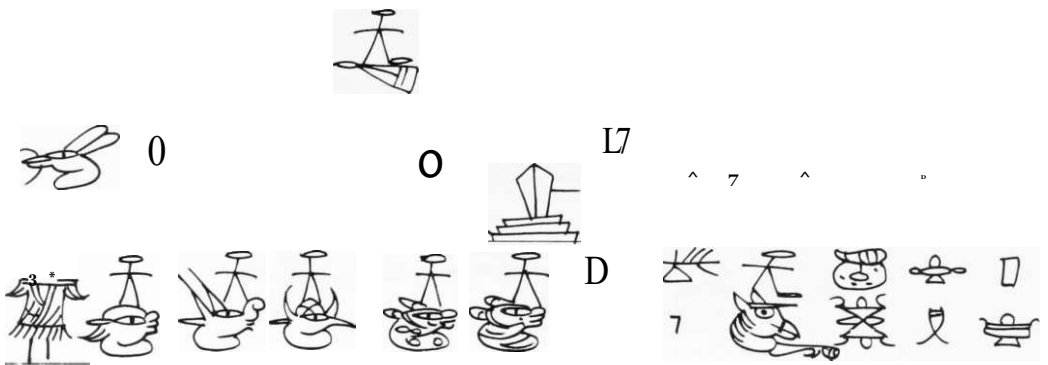

HS. o-r. sim. 5g-i/te. 1190. BLATT

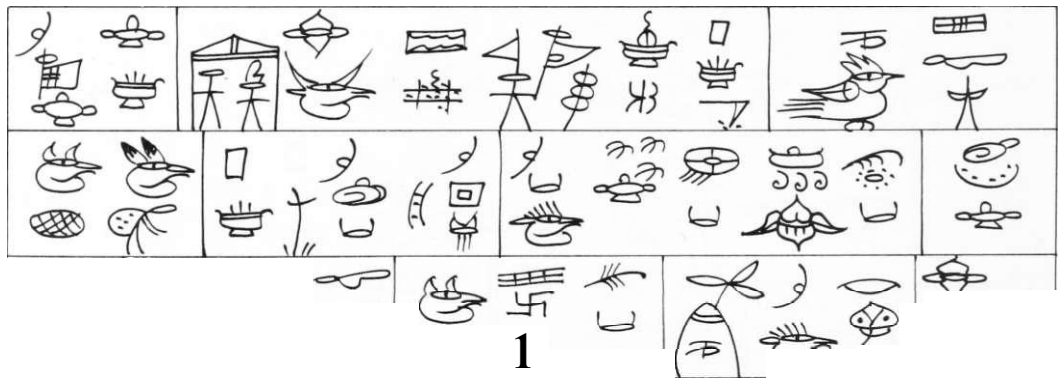
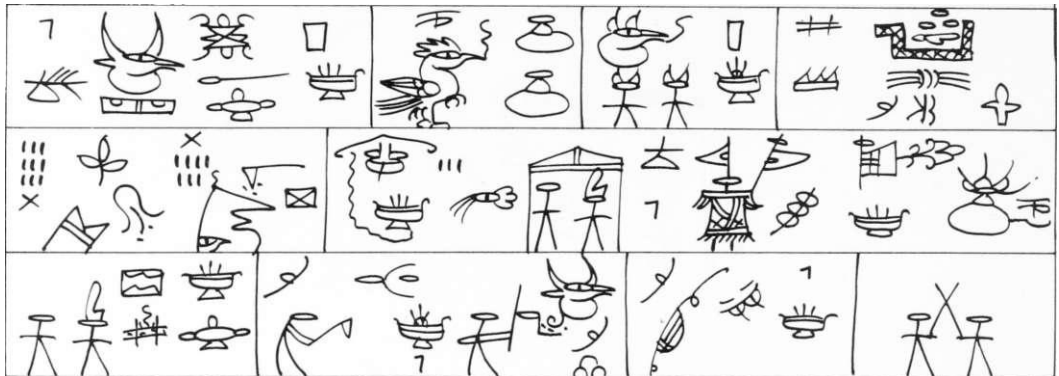

Hs.OT-.sim. 591/fc.ligo. BLATT

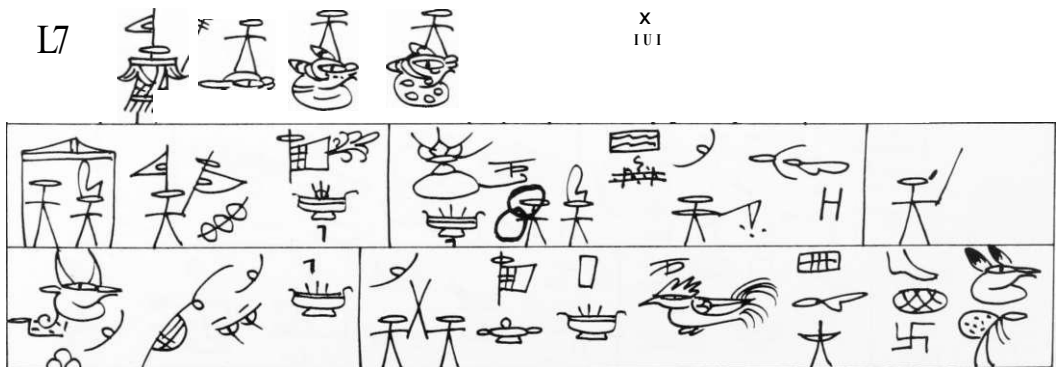

0 6 t,
 T£T ⇔ & £11 tl \$L " 2) <^=T|T^
 C(£) fff-D 4
 0

Hs. 0T, sim. 59'I/B.-1190. BLATTET--

4\$-a ^{im} _{ii}

txa *=u=*

ii



X^x
 X^x
 III

1

Hs. 0T. sim. 591/R. 1190. BLATT 6T-V							

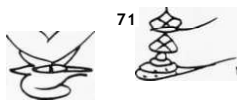

71

|| a j&

77

, \u.

T P

Til

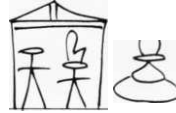

P □

HS. OT-.sim. 591 / B. 1190. BLATT T-

ü



7T

IL

IL



111
11



=LP-



1

Je

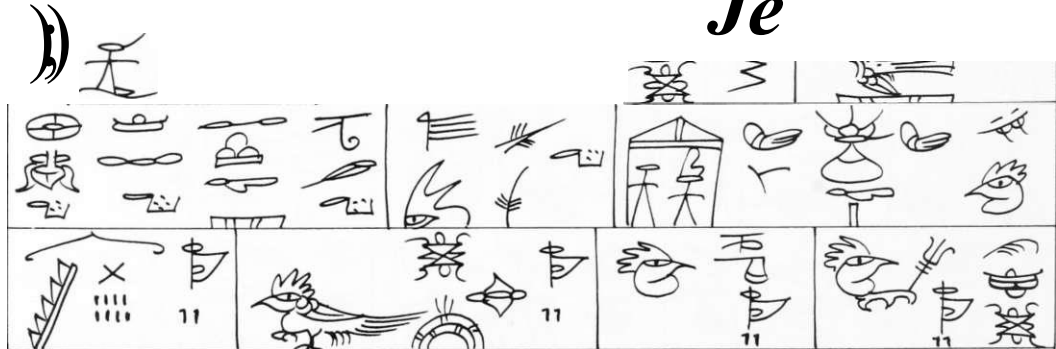

HS OT-.sim. 1190. BLATT 8f"

11



Po.

^

1

0

X

s

U

^



TS/

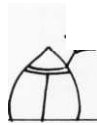

3s



JL



HS. or. sim. 591/AR. 1190. BLATT 97--v			
		Ä HA ^	
j - =ssa Wf			

	MI ^ - 1 III III ^ HI y ?	^	t
3 ^ 3v			
HS.or.sim. 591/B. 11 go. BLATT 4 or - *			
	((rjrrjft, 15L±	/ \	(ti \
	P to a - S ^ L		

	l3			$\hat{y} < \hat{f}$ $\gamma \gamma \gamma$	$\ll 4$	$-v$	1
					0	^	
	X ³						
HS. or. sim. 59-1/ R . -1190. BLATT 11 T - - *							
		[feX .					
	»To ↔			it 1			

Hs.Or. Sim.591/β.. 1190. BLATT 1 ^ r

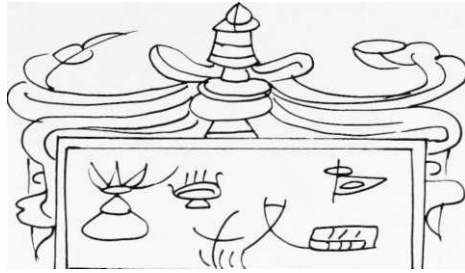

xiTj; 9^ UJ, Z> - Hs. or. si m. <oOS/R. 1918. HOT La- llii. tfö. Wu. bpö Dto bpo U/u-bpö. BIAT 1 r-

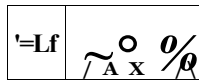

i n

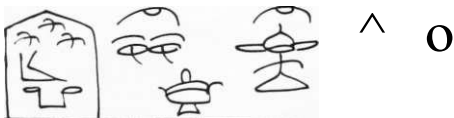

Hs. or.sim. tOtf/ie. 19'tS'. BIAT



4> 3



X'^Lr JI ^D x i ^{MI} 3 v

"LTQ





xxx
xxy
xxx

xxx^
xxv



Hs. or. sim. (008/B. 191*. BLATT 3' - ^



VT



X

n



x^



VT

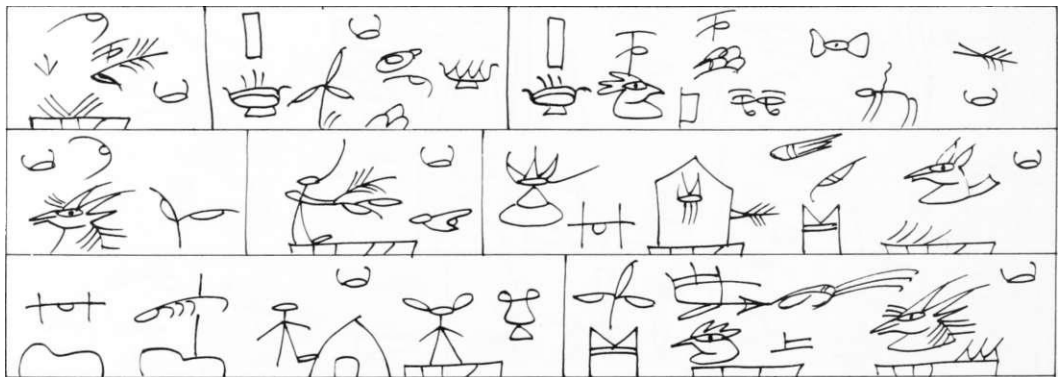

Hs. or. sim. (o08/fl. 9^8. BLATTf^



93
W

<<
3

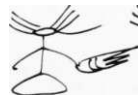

°LP

P



i n



n r

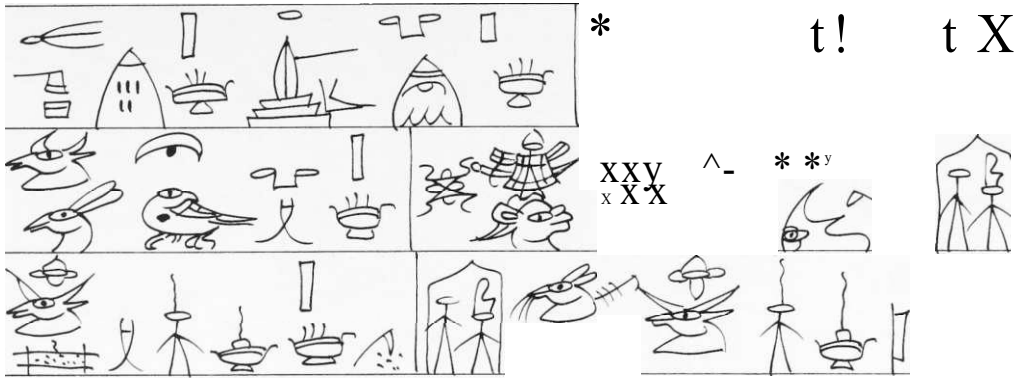

Hs. or-, sim. feOtf/R. 1918. BLATT 5 ^

o X

Ffd

 5 ^
 0

fU o
 I M1
 I II 2 D a
 1 @

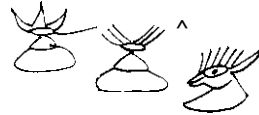
4üi

 o X

x) 0 ^				
		m	n	
		¹ m J L Ä %		# l
		& AX ^ X ^ • = Lf(1ST Af		1
HS.OT-, s!m. foOff/n. 4918. BLATT t>T- "				
X	v (X ~a		^ 4 X	L P ?
^X) X	∴ III
				^ P

r		
t f y ^ i f ,		
HS. Ol-, sim. foOS» / R. 191«?. BLATT f'" - '		
P ? A ^		
if***s D		
5* to	töio ^	I i

r A r ^ < ^ ^ 1 M X A T ^ 7	M /
HS. or. sim. foOF/R. 191tf. 8LAT 8T-v	
9 0 ? <=4^-	a ^
^ < y x A ^ = > ^ • « • i L , => /*	
1 , , ^ \$ ^ ^ f ^	A

ft

D

MM
i < l

n

iL



b



Hs. or. sim. foos/B. 491s. BLATT 9^ - ^



^ X



a

—©)wx



xxx

<i>A</i>		<i>m</i>	<i>£p</i>	
		<i>X</i> [^]		
<i>n_r</i>	<i>CCF*</i>	<i>n_r</i>		
HS. or. sim. fcOtf/B. -19-15. BLAT 10^				
— <i>a</i>		<i>A</i>		
		<i>XP</i>	<i>a</i>	<i>ft</i>
			<i>o</i>	[^]

⊙



4^

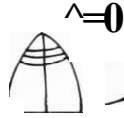

^ Cc=?



o

Hs. or.sim. <008-19-1*\ BLATT H ^ -

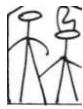
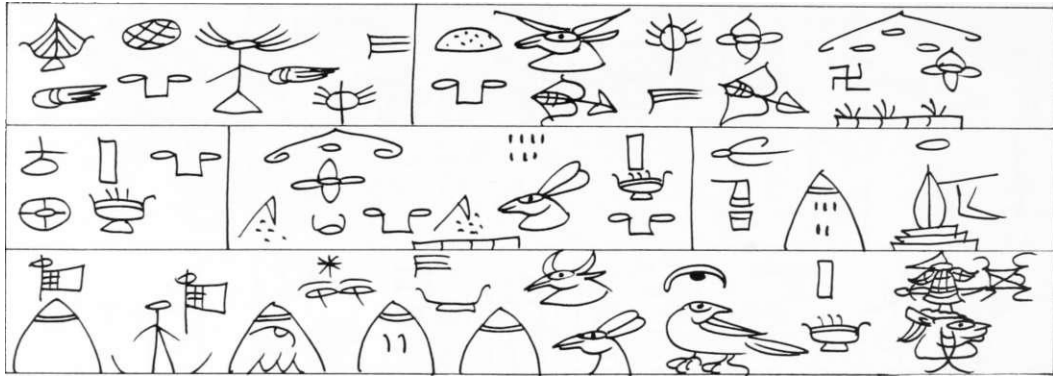

ü

D

X

4-

D

ffl

-3

i L

3

Hs. OTv sim. <oO&/PL. 191^ . BLATT12,-r--

^ 7

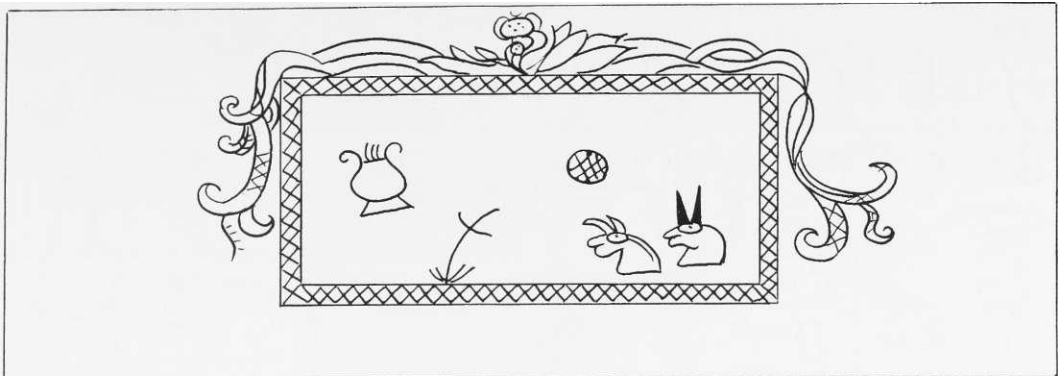

XIII, 97, w, 2 - K.Ot. 215/R. 8218B. Härt-la-llü kö. Wu bpö. BLATT 1r-v

oder XIII, 111, a
oder II, 11

ROCK:

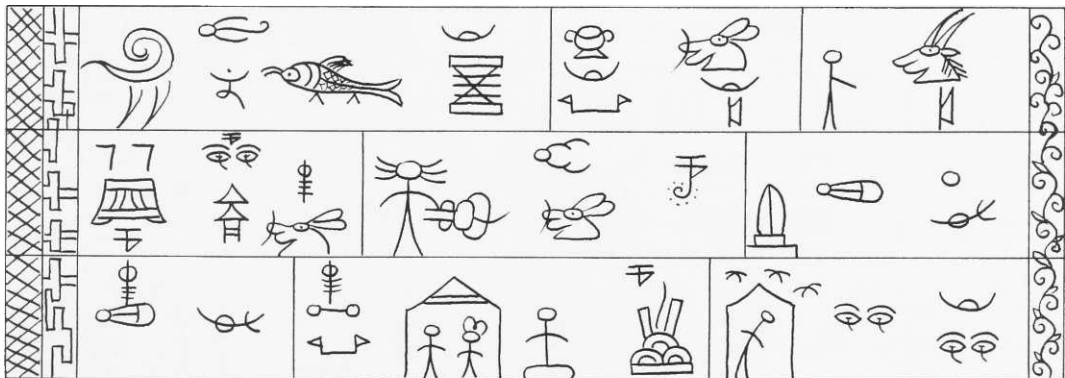

K.Ot. 215/R. 8218B. BLATT 2r-v

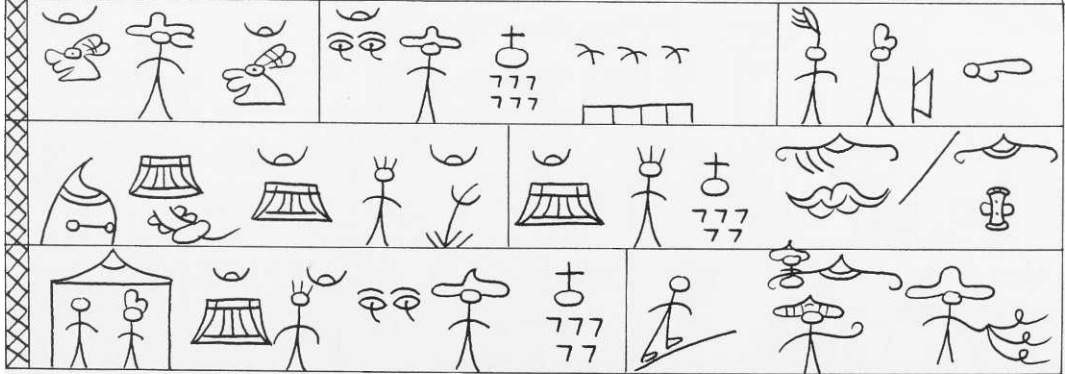

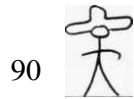

X X X
-7 7 7
1 V

-H-P
Ä s¹-

-e-tr

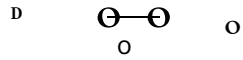

o o °

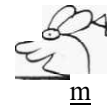

K.Ot. X15/ie.SZ18B. BLATTS^

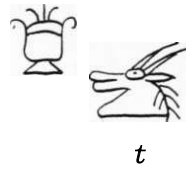
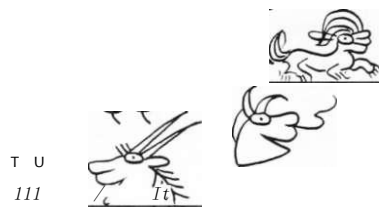

ix« ¹¹⁷ 777

D

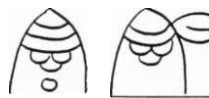

J7X

K.Or, Z^S/^-' 8Z>18 B. BLATT 4.



n



O



7 t ^
i n D^d • 

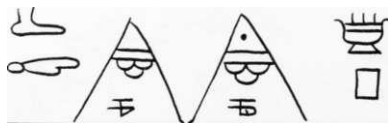

N



FE



•		° — A/¥	
lll		t f ^	& Ar°(R) _B >
K.Or. 2 15 / R. 82/1*6. BLATT 5* -'			
-777 78)			• i © .
ca w A			

		tfi ^ ^ >	
		>	rni^ m m r ^^S^C
f A .		• ^	
l/yds- *A£) kkk			
K.Or. M5/R.8/18. BLATT (*-			
™ A S ,		Co) *	
^ ©	^ -7A & ^		w \J/ M ll li li
vk vi/		& 4 A	A A ^

Xlii, 9?,w,Z - Hs. Or. SZS/R. 8%V5B. Har La-IIa ko. Wu. bpo. 8LA1T 1* -"

	VVb ^ =F ^	

4 ^

 --

111
 111
 Ws.Or. S2S/ft. \$2,2,58. ^LAW^~

AAA

.

AAA

iL ^{AAA} t JL . ÖS

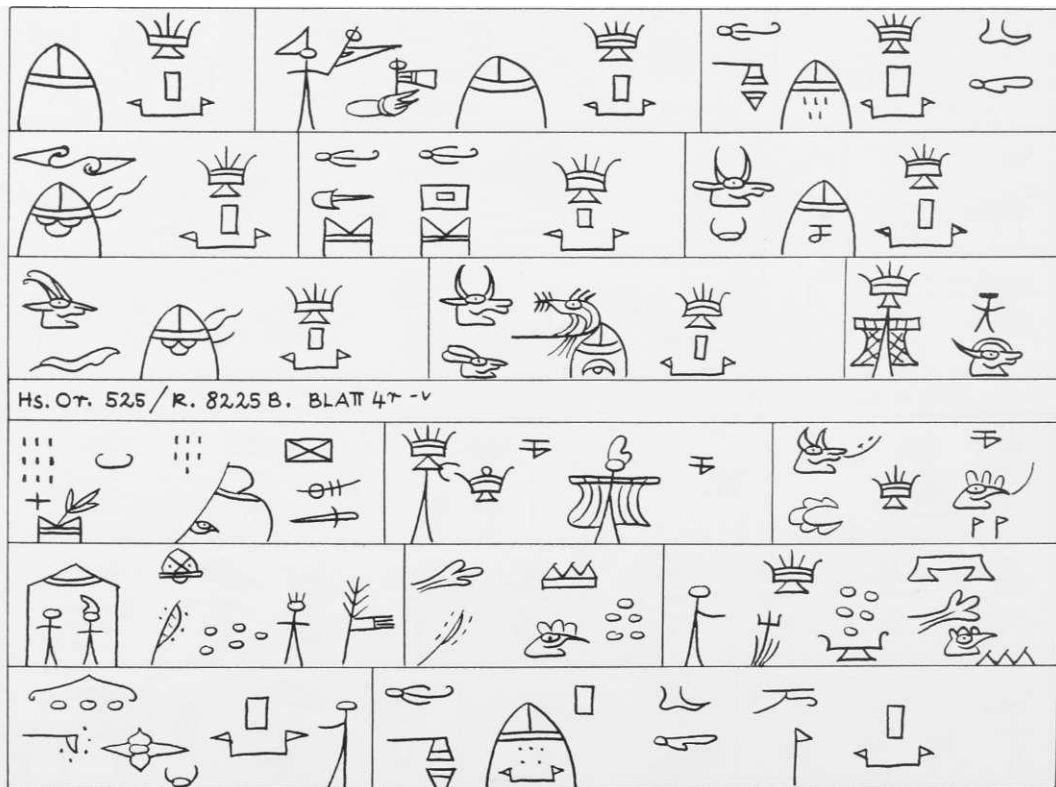
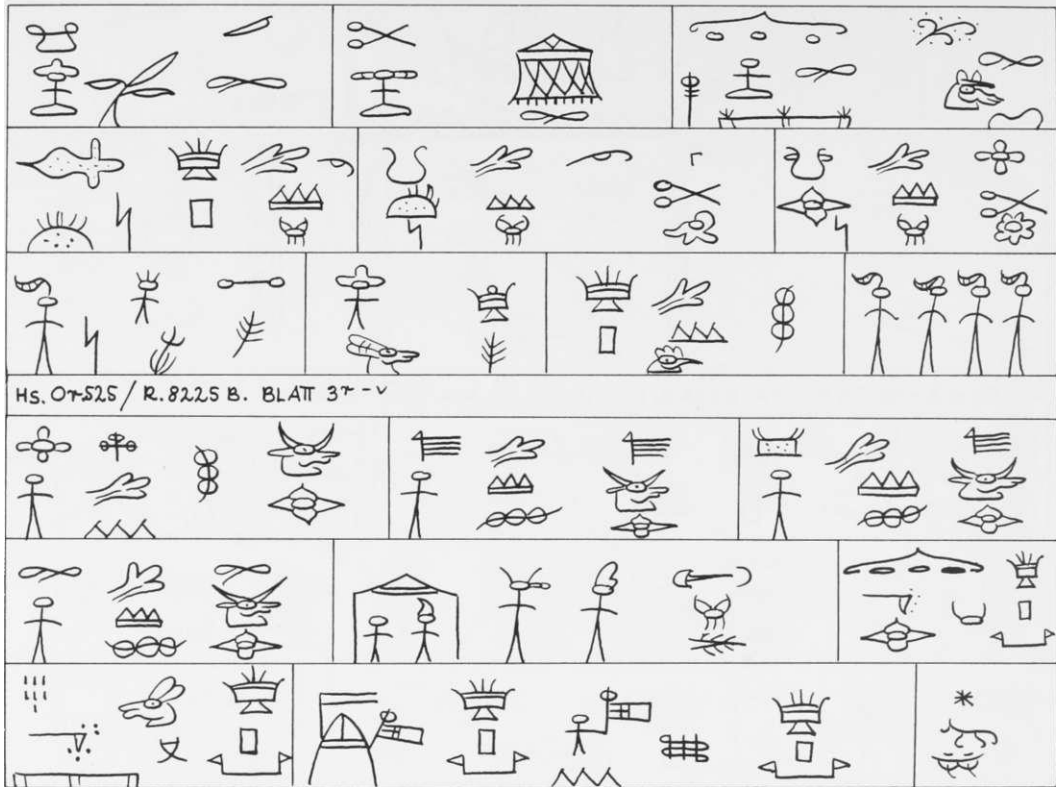

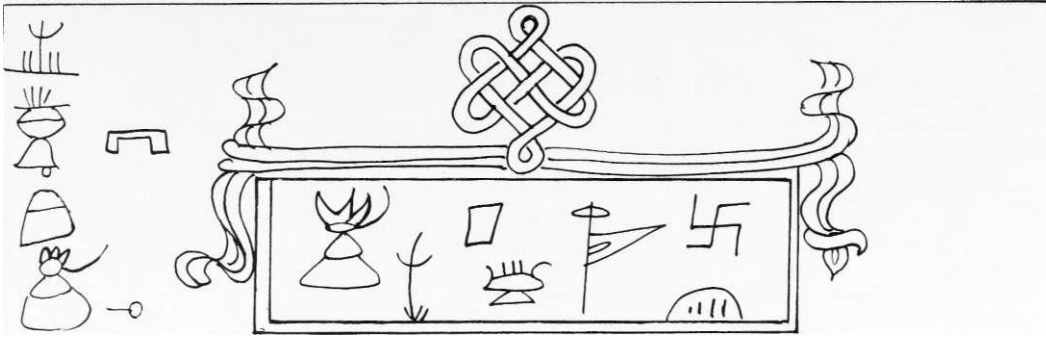

xm, 9i, w, l - K.or. 344/R.*429. Ha>la-ilu ko.U/u bpö. BLATT I^v
oder II, 11

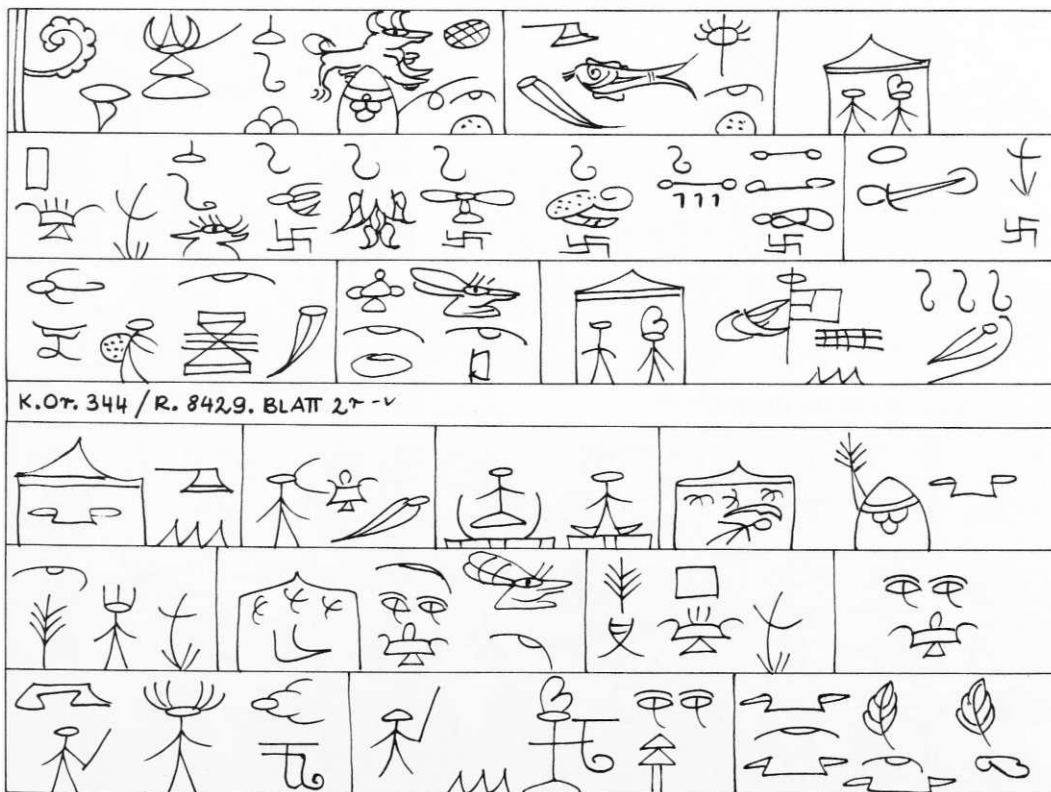
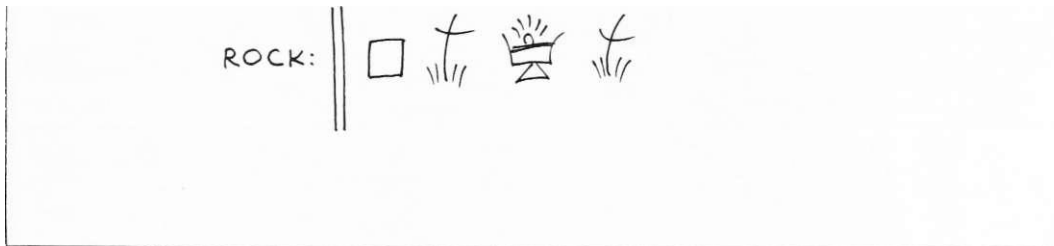

p X D



D



K.O>-. 3^*f / R. *<t2,9. BLATT 3**



• in

E3

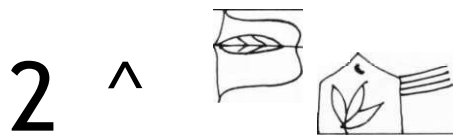
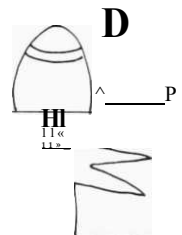

in

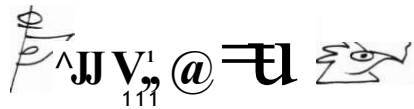

1

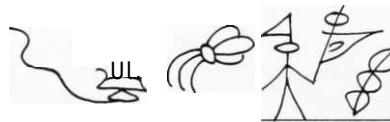

1)

r f - n

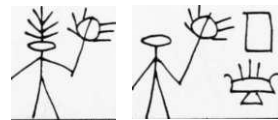

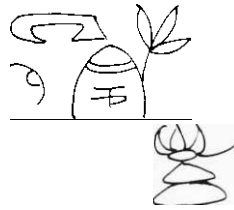
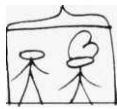

B

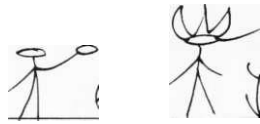

K.O*.3f<t/R.£42v9. BLATT 5T

n n i i r r

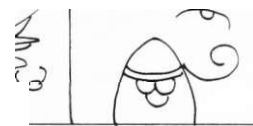

ä f 1



^ 6

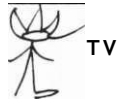
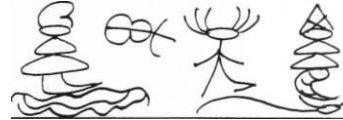

<H5



K.OTK 3i+4/R.y^2v9. BLATTfoT

i f f

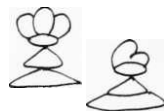

ß

?4t IMÄT-

o
o
o

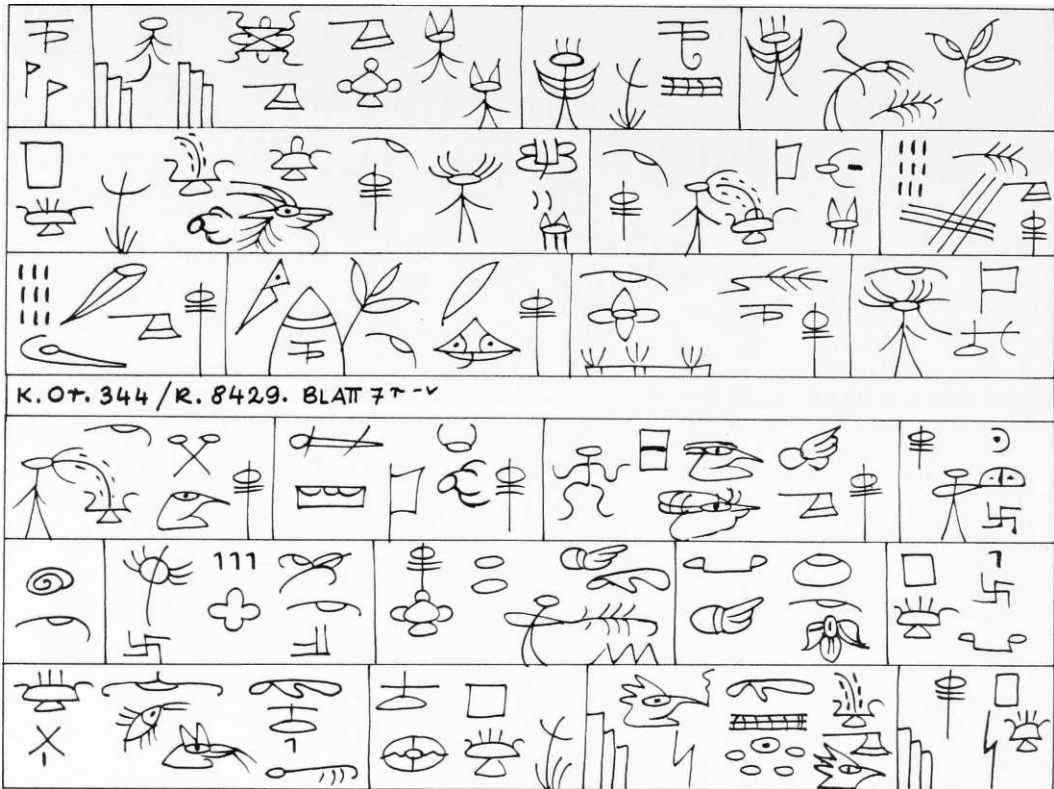

		• f	• A•if?
		•	
		<i>ft*</i>	^ r
		f	^ Ulf

K.Or. 34 U/R.. 42,9. BLATT 5

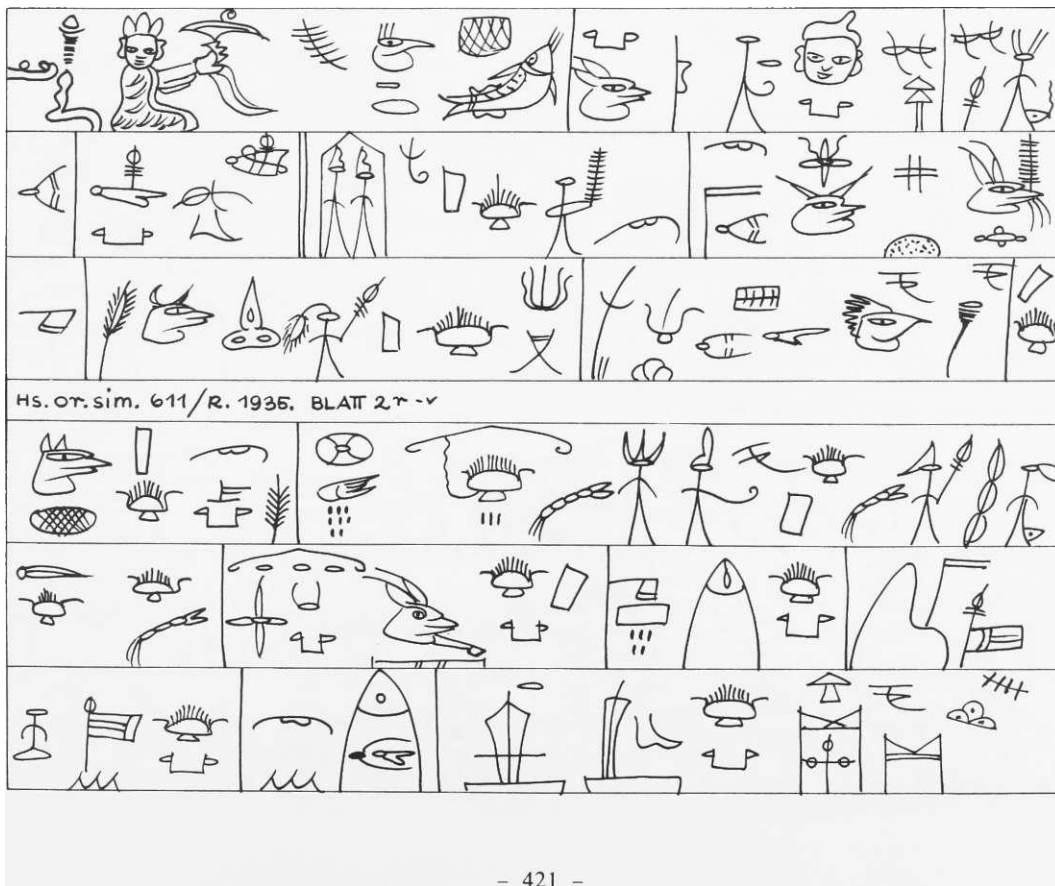
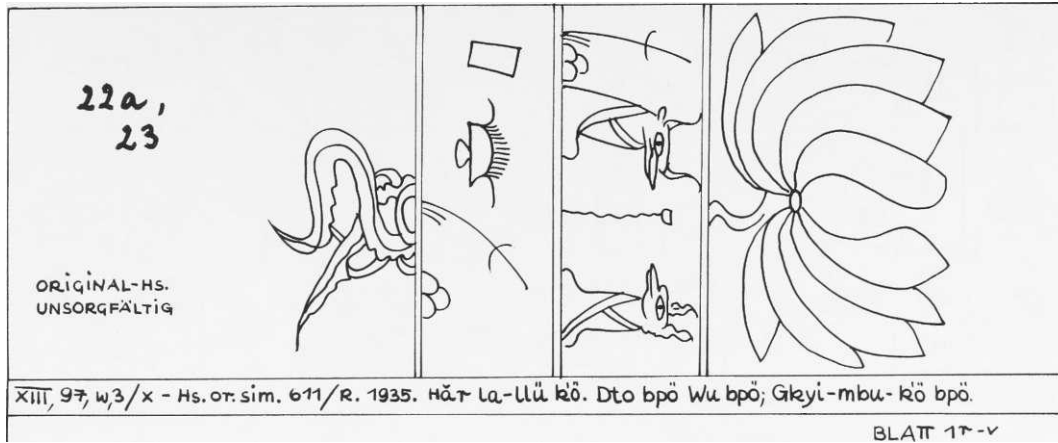

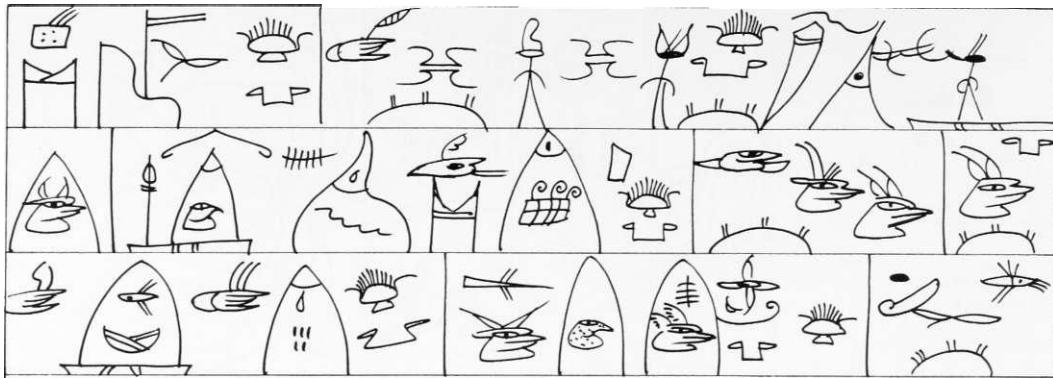

HS. or. sim. fc-ii/B. i95s. BLATT a ^ - v

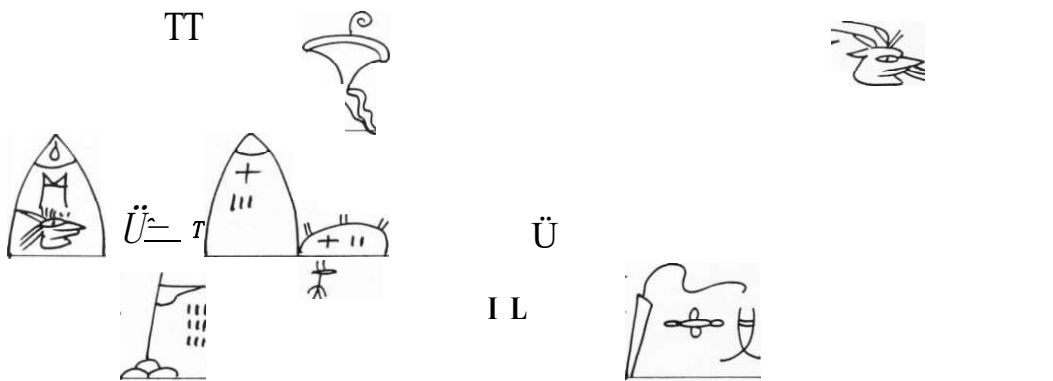
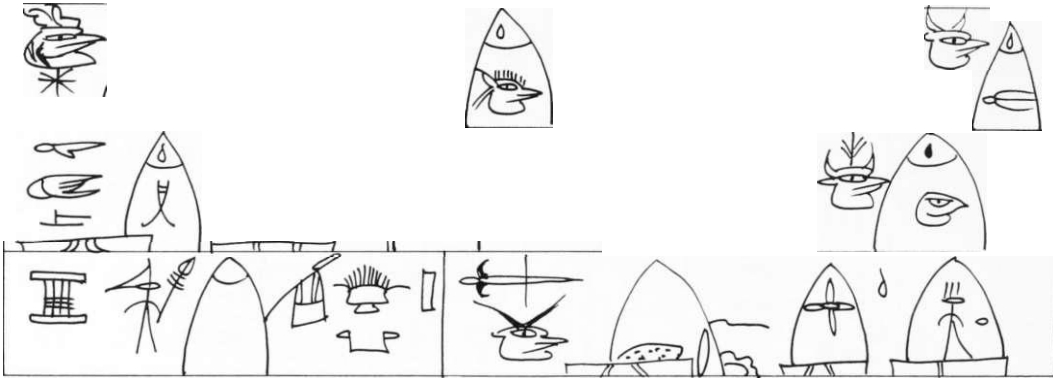

HS. or. sim. foil/β.1335. 8LATT lfr--v

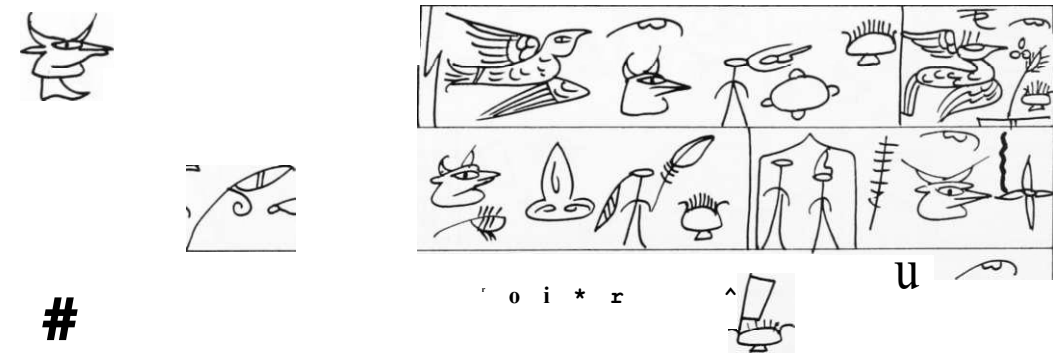

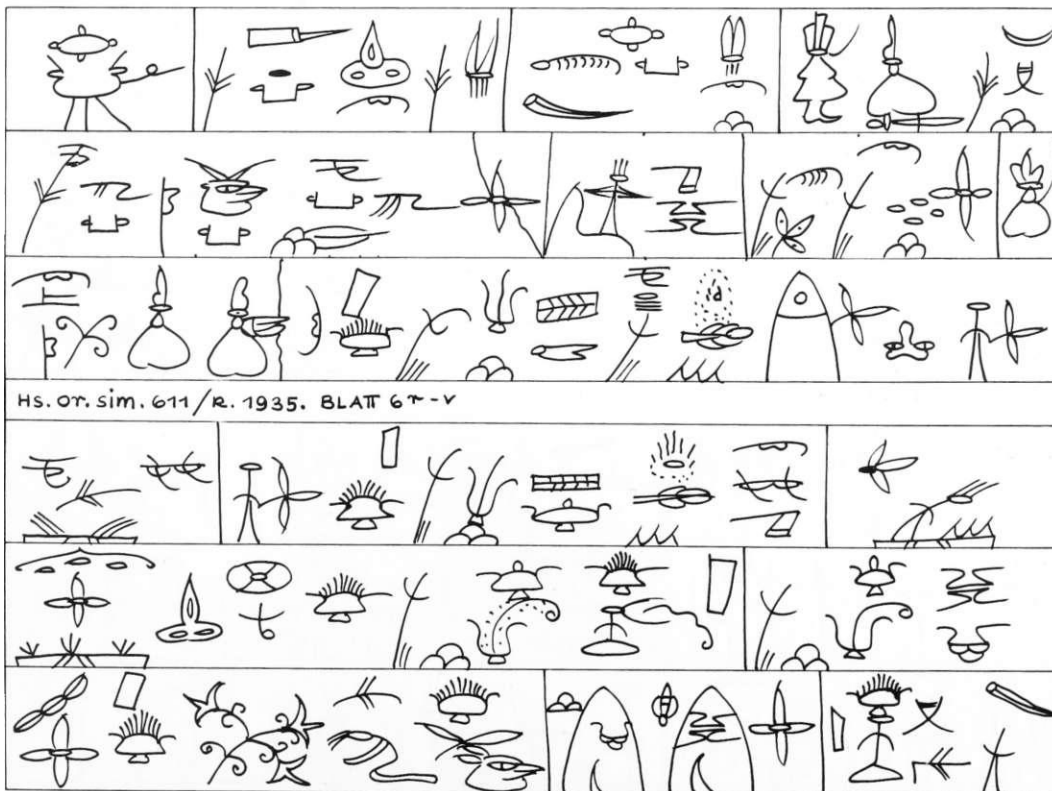
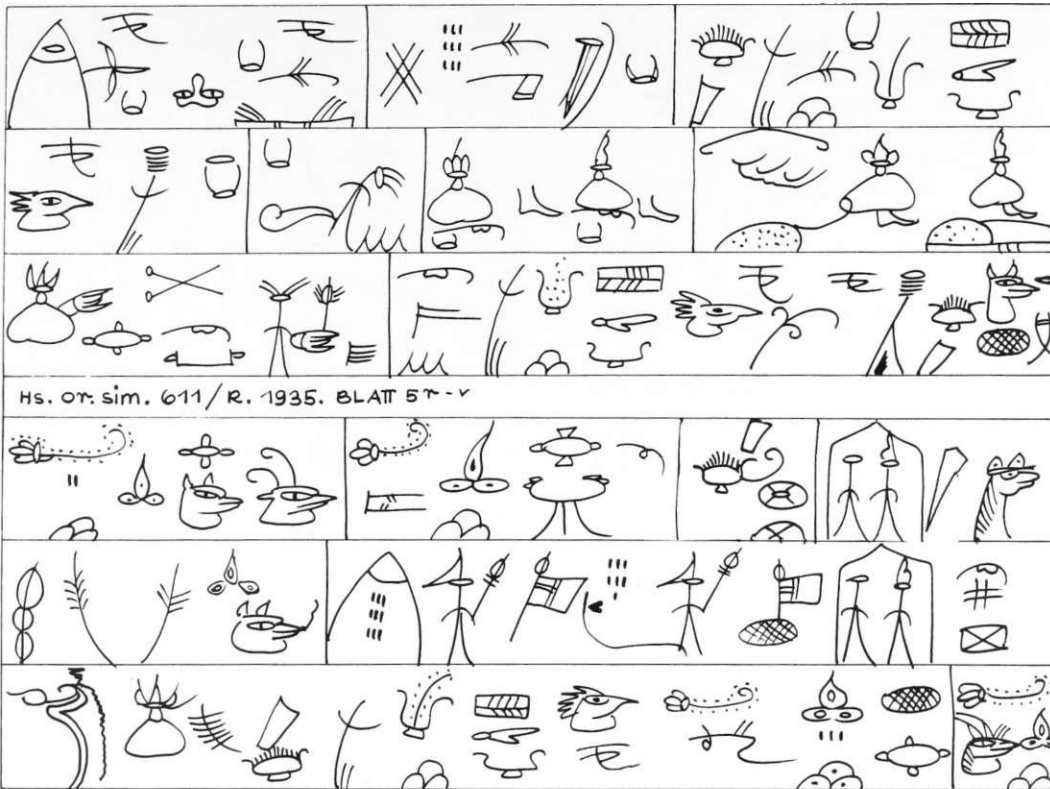

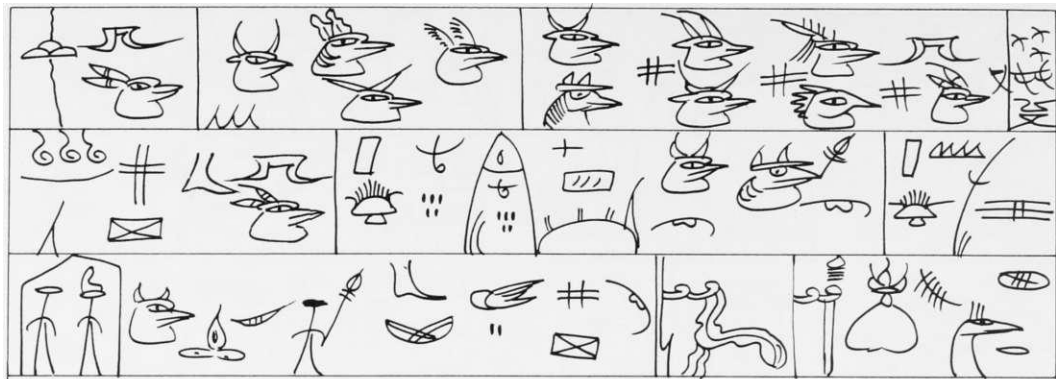

Hs. Or. sim. 611/R. 1935. BLATT 7r-v

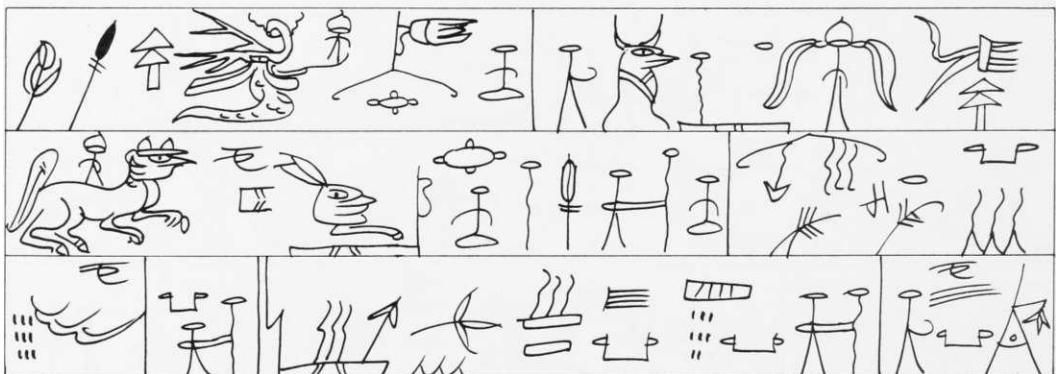
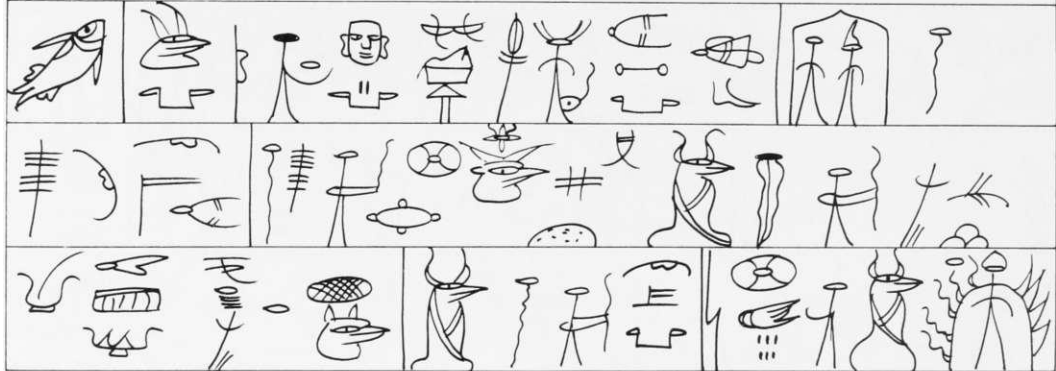

Hs. Or. sim. 611/R. 1935. BLATT 8r-v



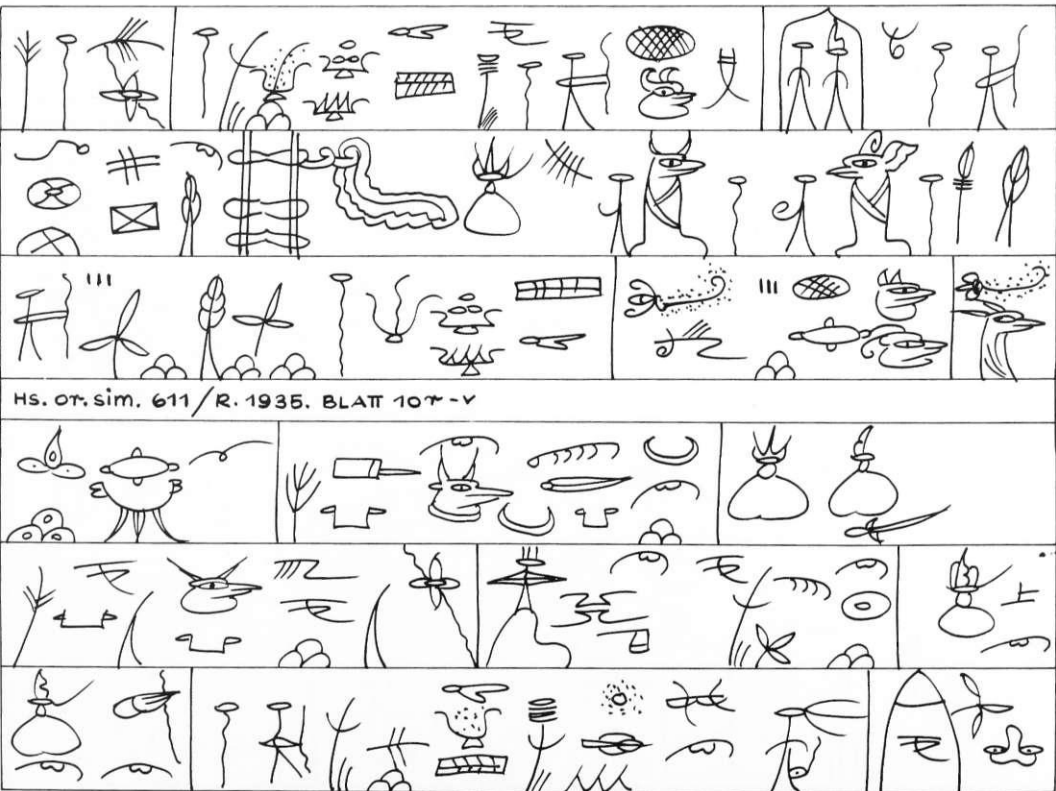
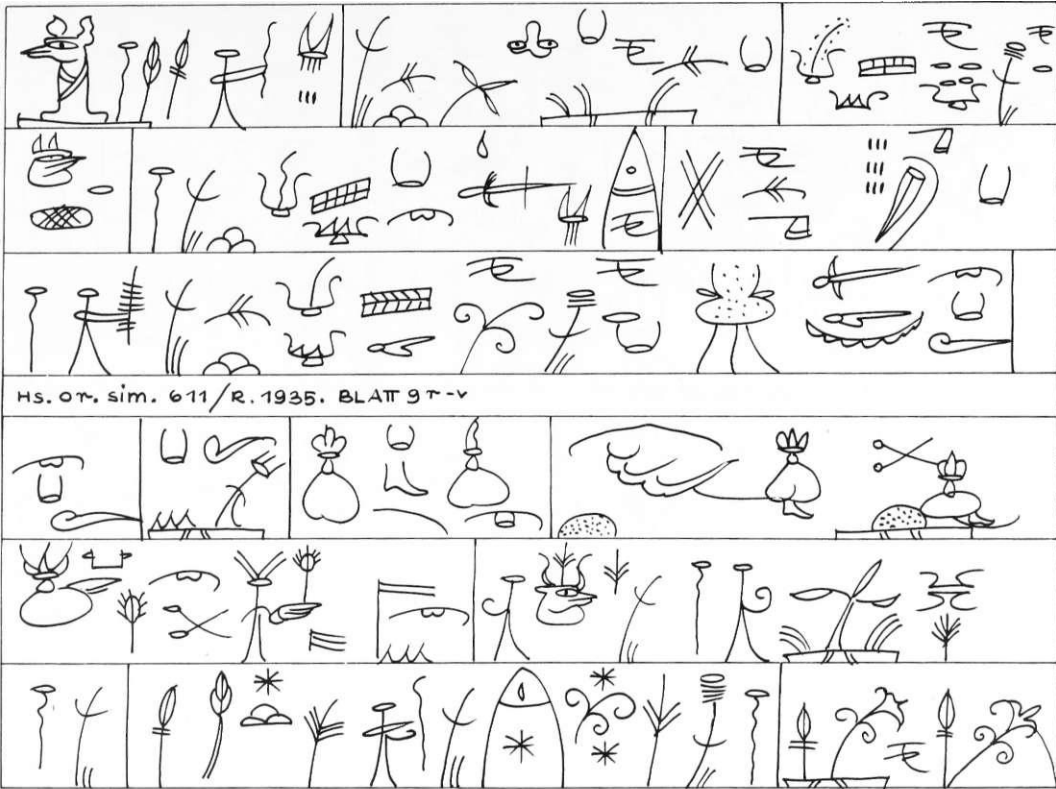



Hs. OT. Sim. 611/R. 1935. BLATT 11r-v

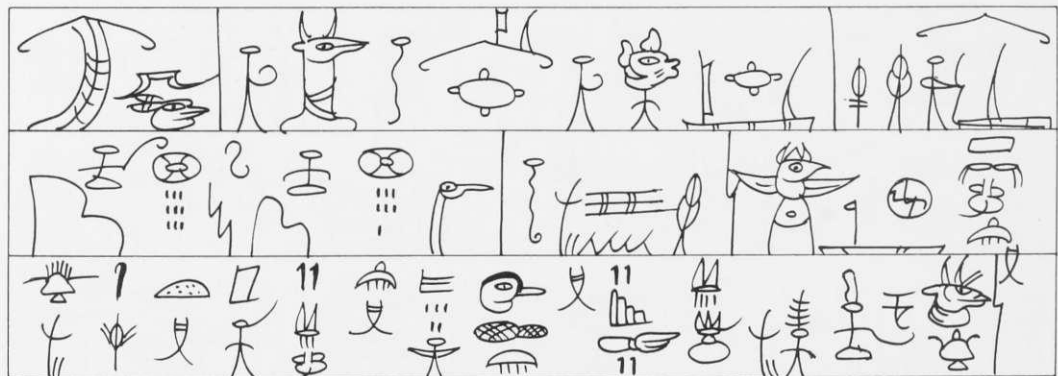
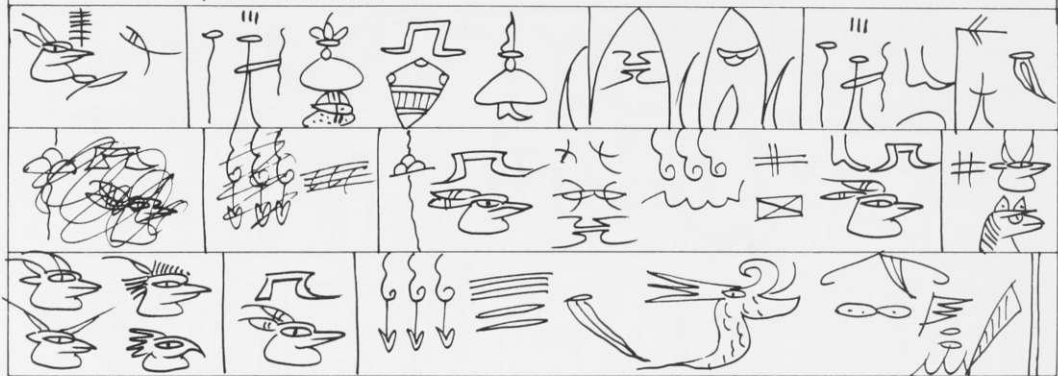

Hs. OT. Sim. 611/R. 1935. BLATT 12r-v

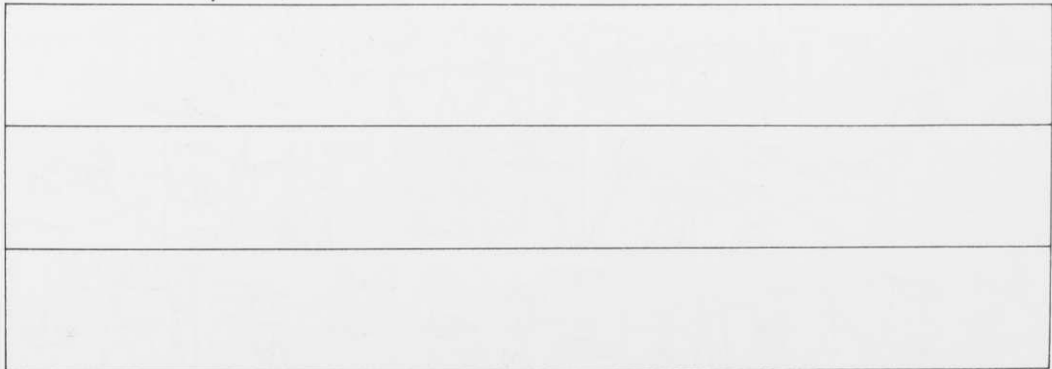

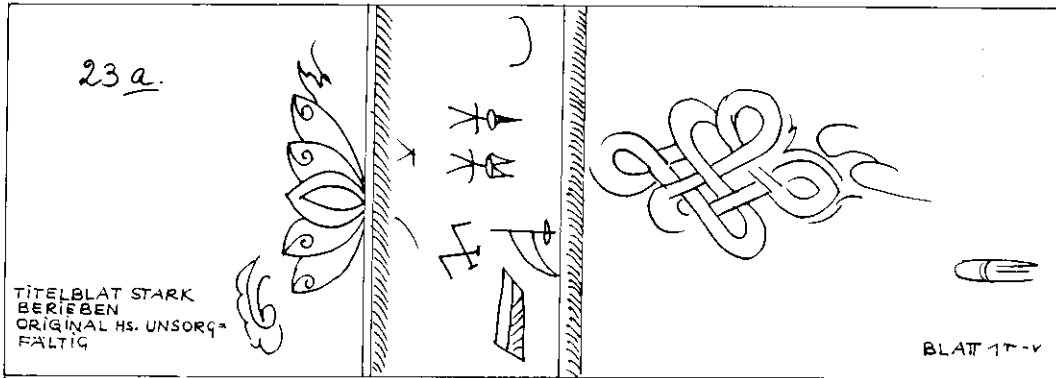

XIII, 97 x, 1 - Hs. or: sim. 679/R. 2144. HÄX La-lü kö. Haw-kehi dto-ma gko-gkan kö; Dto bpö Wu bpö.

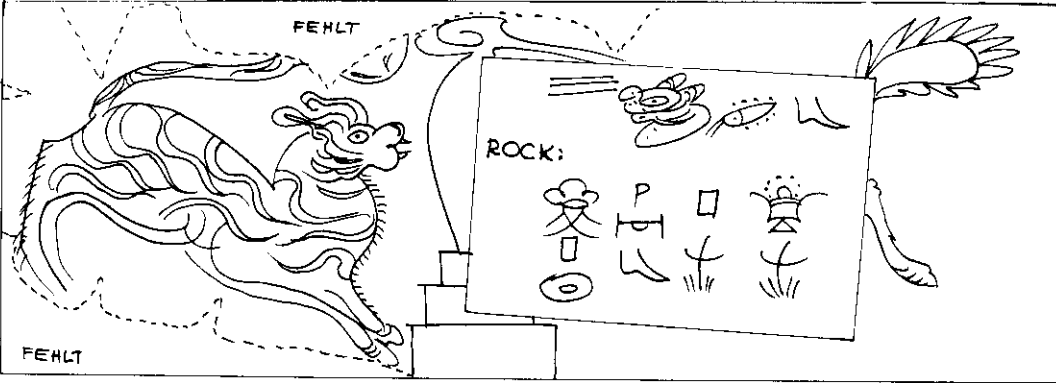

O S

^ P 7f



H5,orsim.b15/B.^m4. HATT A.^-^

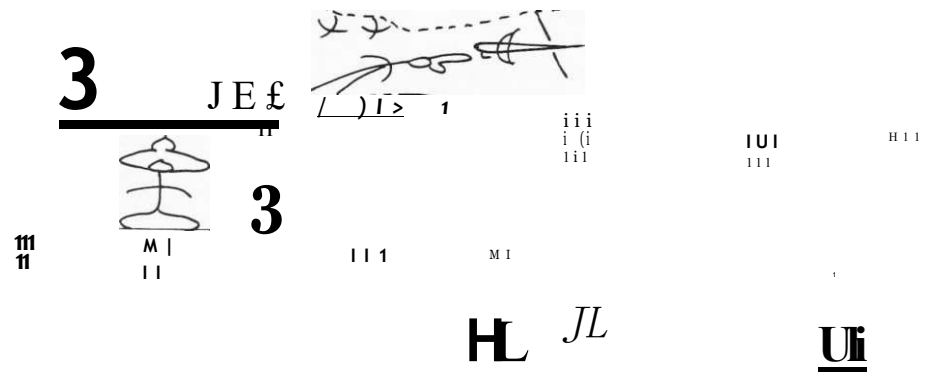

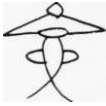

FEHLT-

'3

...AAA

E Ü S J



.OTT Sim..6*15/a.5/l^^. BLATTS""-^

X" N /- \ FEHLT



L



1

TT

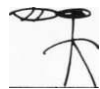

1 H



3L



n



IS

1 H



Hs.orrsvov.. 615?/B...£14 4. BLATT4



FEHLT



o

D.

n

2?
A?

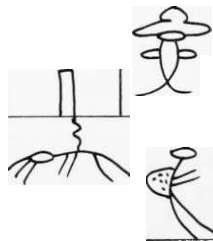

	1¥1	I ^ W - ^ ^ A ?	afe-
	j p ^		
	" " i 7A'		
Hso-r.Si'IM.. /R.i-W.q.BLATT 3-'—			
^ — ' i Ö ^			-TUT r
		i — ni → 1— r	
^ — C c o o -r ^ y		—ffi^— (A	

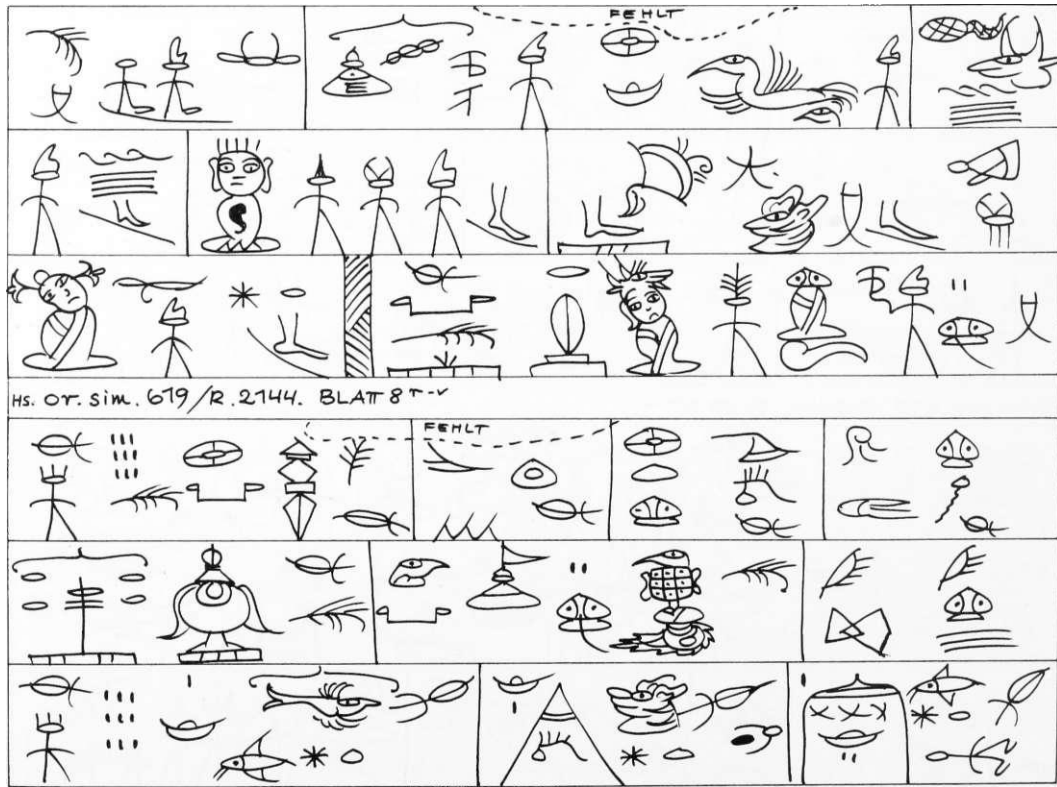

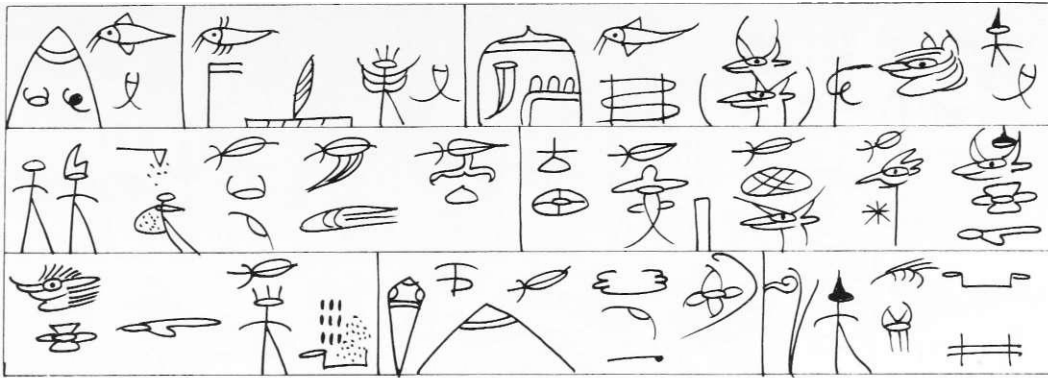

HS. OT. SIM. 619 / R. 2144. BLATT 9 r-v

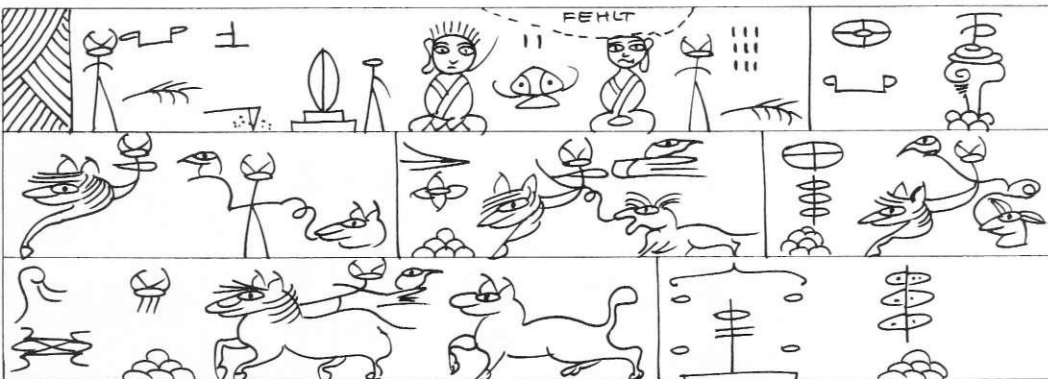
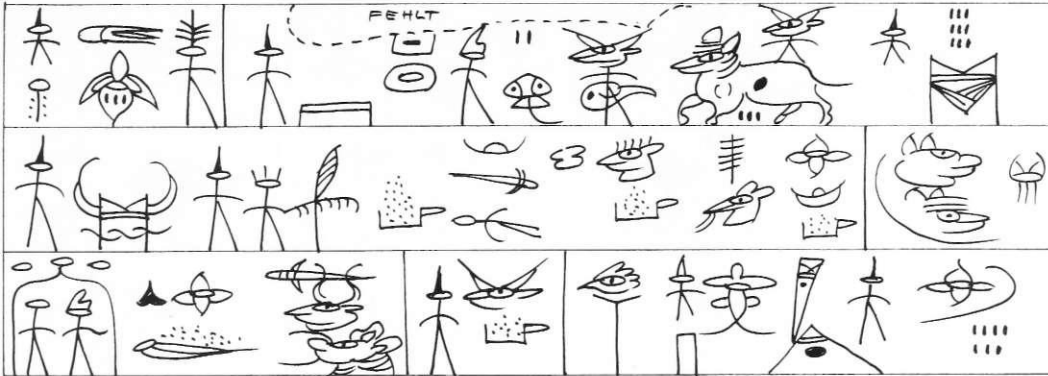

HS. OT. SIM. 619 / R. 2144. BLATT 10 r-v

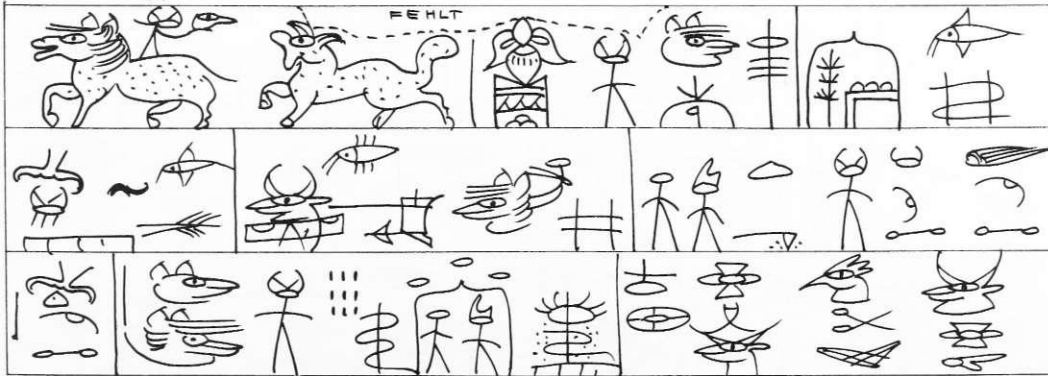

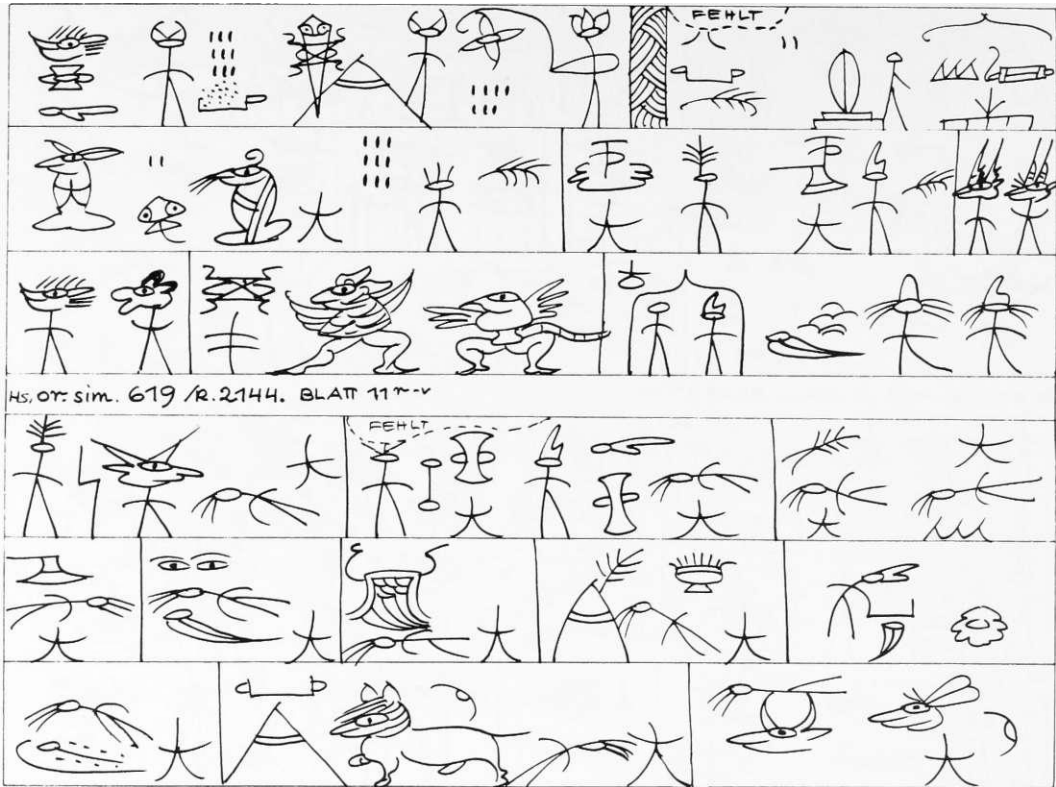

HS. OT: sim. 619 / R. 2144. BLATT 11 T-V

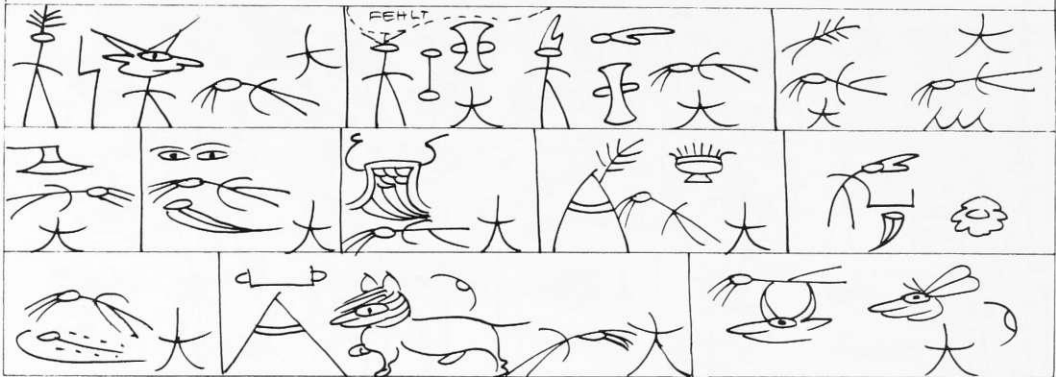

HS.ex« sim.. £13

BLATT 12 ^-.*"

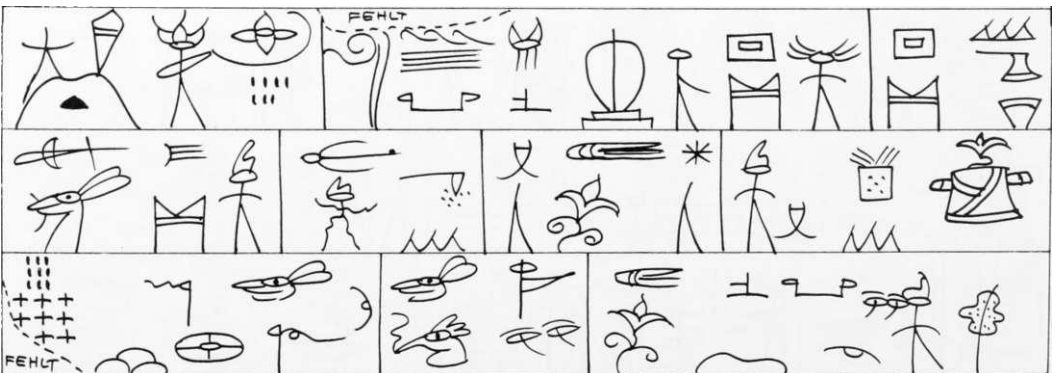

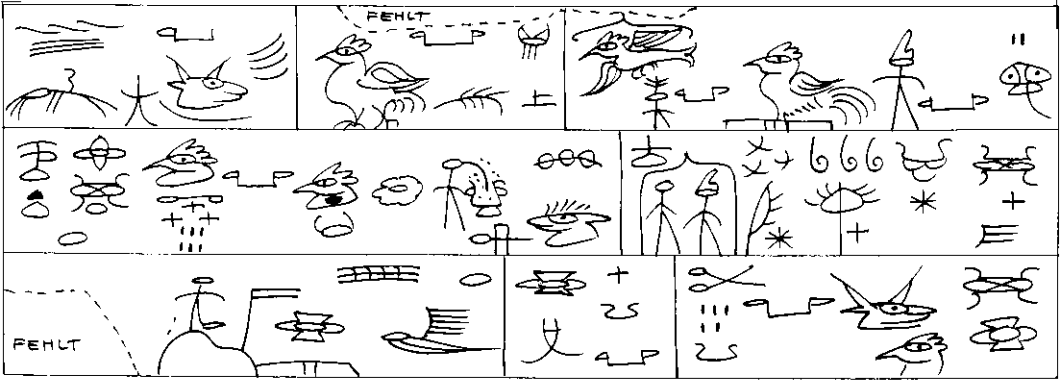
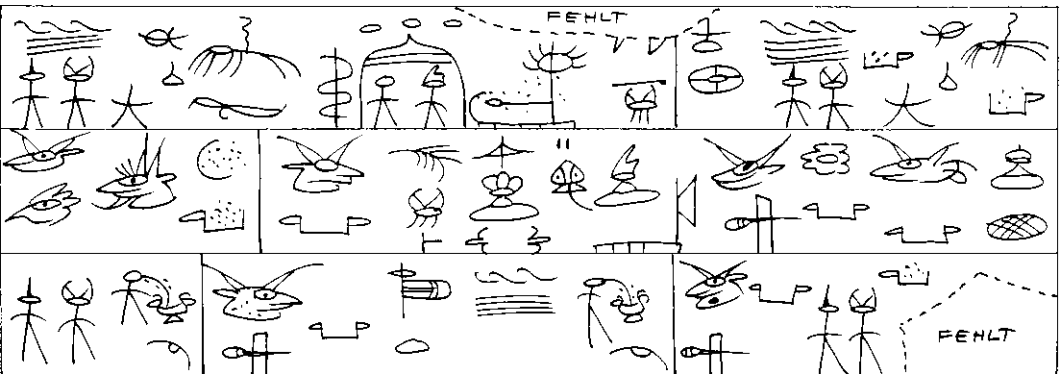
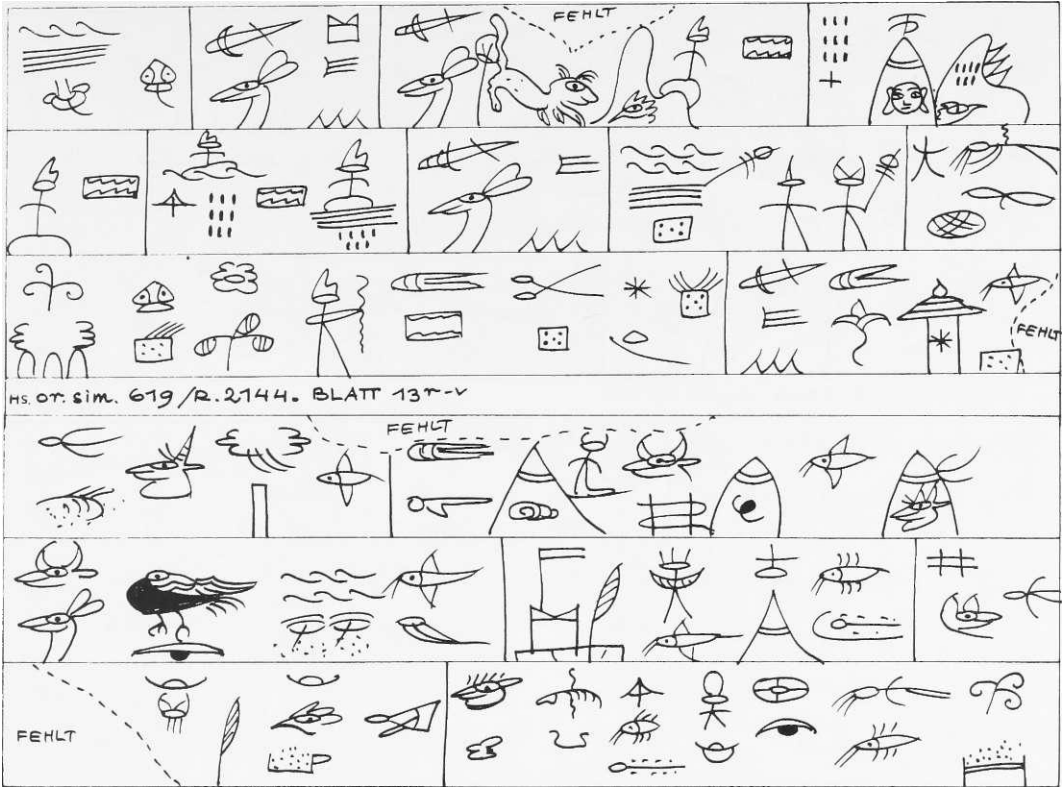

人



HS Orr sim.. 6>-1J?/B..2.-1-44. BLATT-15'-
~ FZ FEH-T

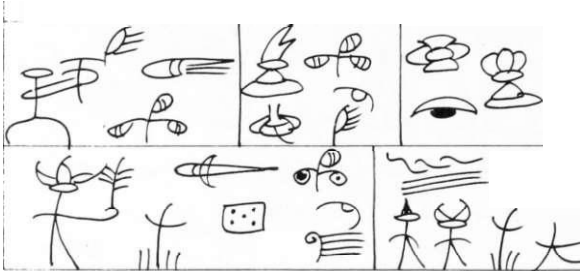

IL
3 Y ^

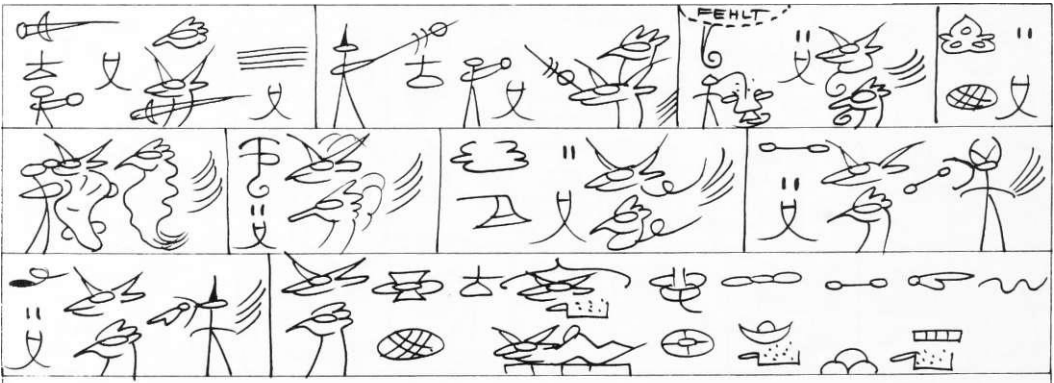

HS. OT. sim. 619 /R. 2144. BLATT 16r-v

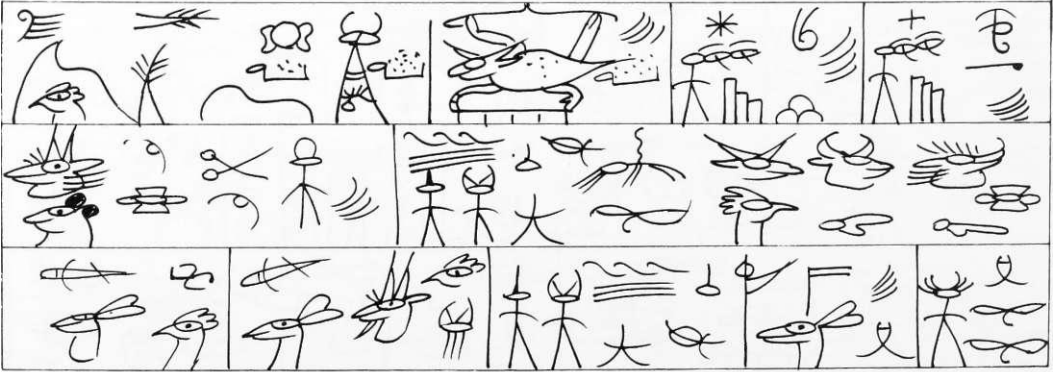

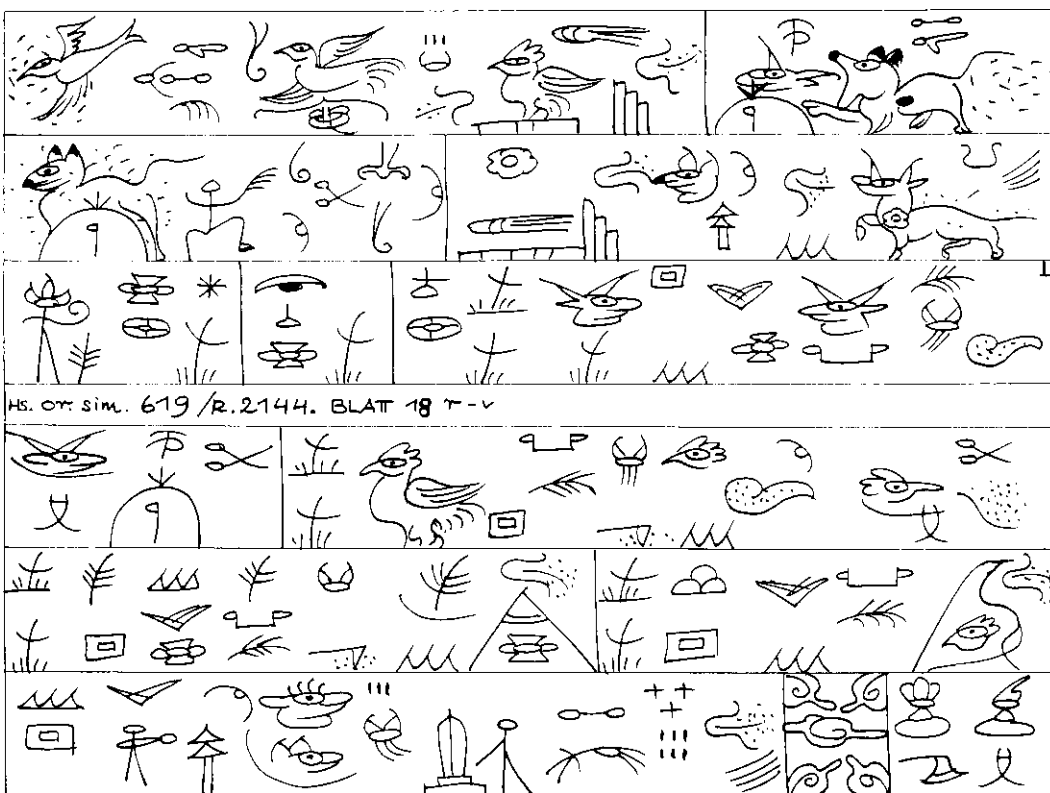
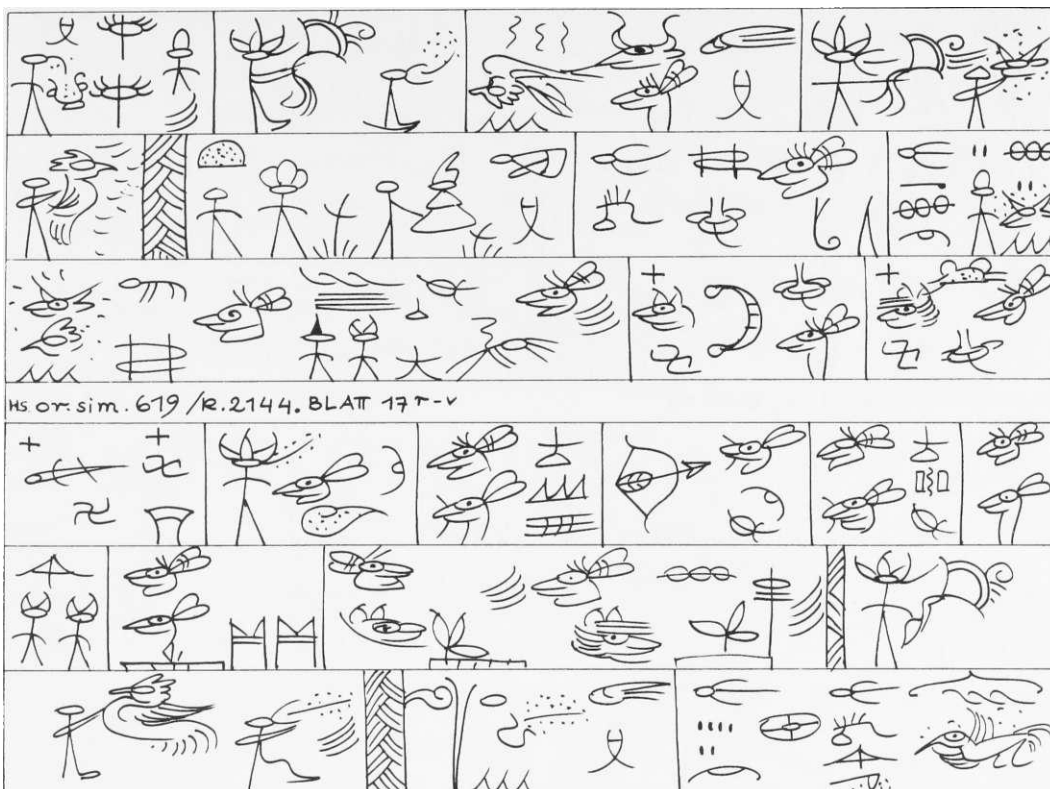

4			
D			
T^f	i d -		
			—A^A—
Hs.or-i-inc. 619/B.2,144. GAIT-19 ***			
i			
		-4 S	-S, J L

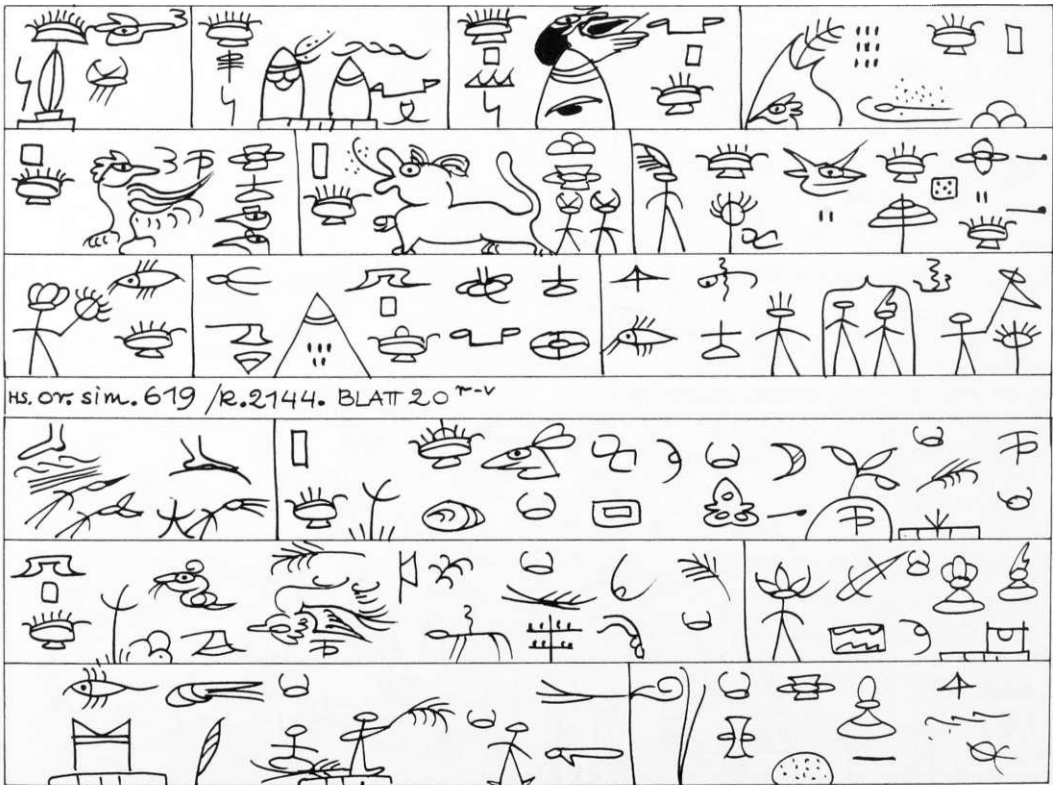

. ^ wiener, - "			
^ Sxi		^ «J h~ ^ r ^ x let	
		*_ fr ©	
I I i >		a L f^?X	
Hs. or: SiwL.£19/fe.2.1^q. BLATT2j1 ^{tr**~}			
		TY 7\ 1 \ ° }>	
1		x	
- e r f _			

^ 3 L ^ <3   77 ^

WM/



7 ^ VFL

^ cp
HAU _____

Hs. or; Sim.

fc.19

BLATTÜL"

r i i i

ft



4 1



D



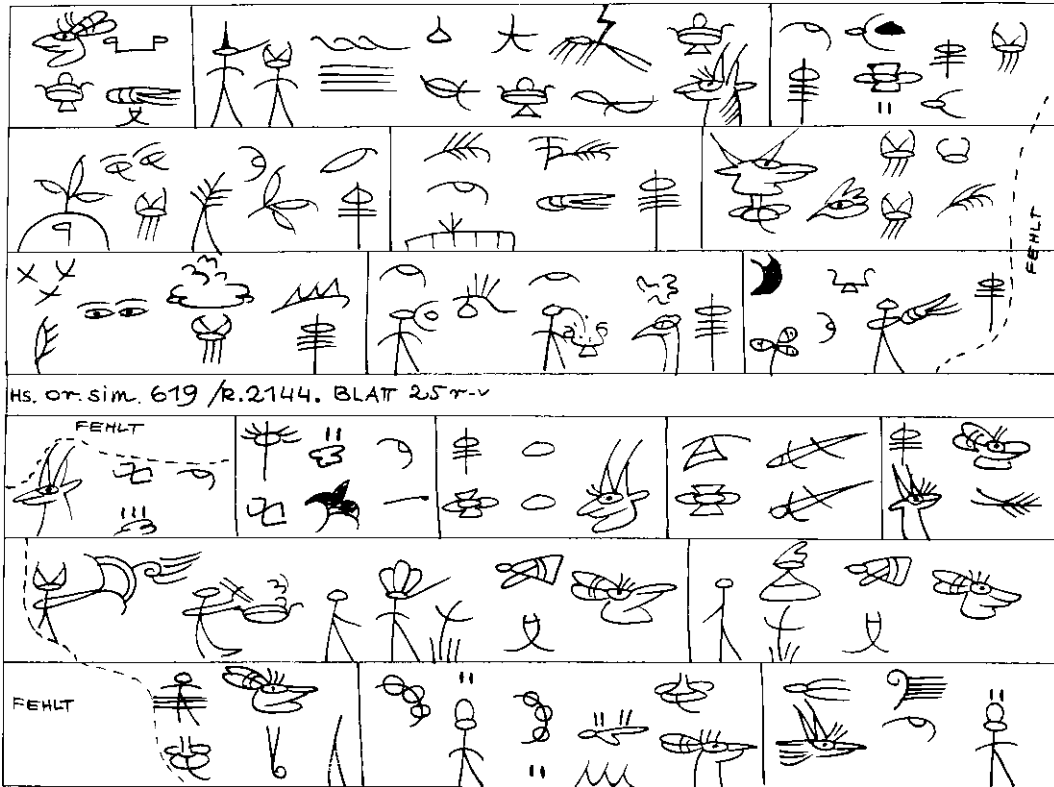

HS. or. siac. fo15 / B. 2-1 4 4 . BLAT ^fc^-^		
	AAA	^
	f	=

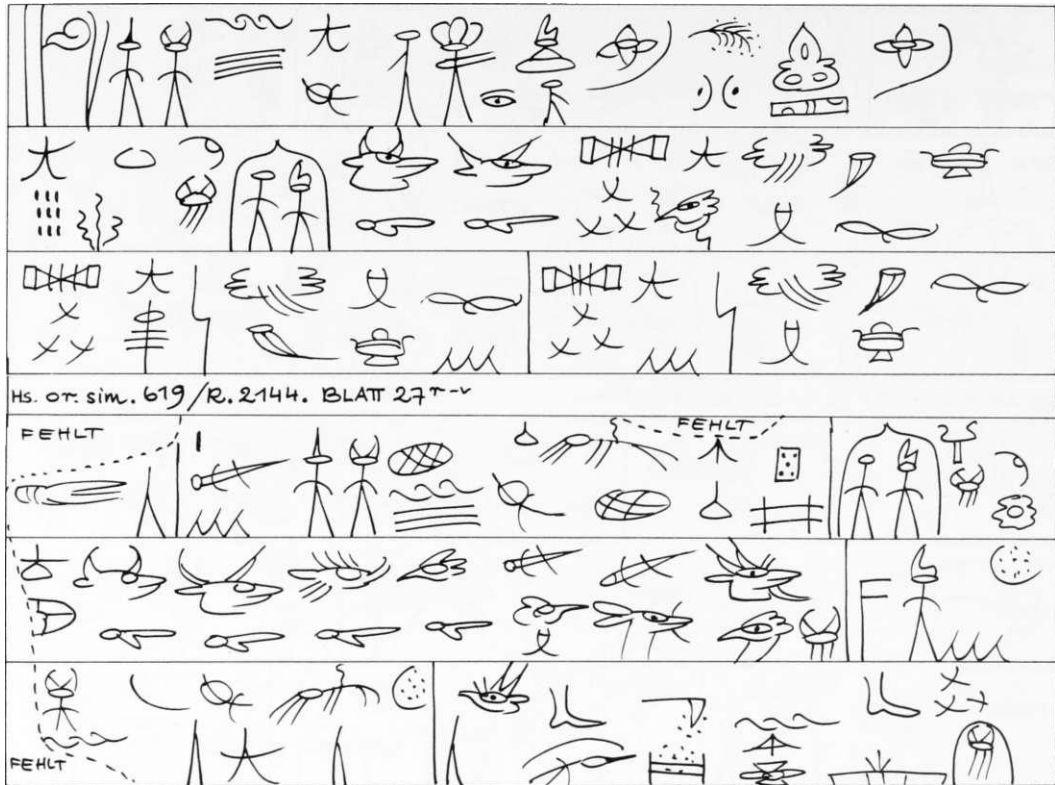

	FEHLT
	i

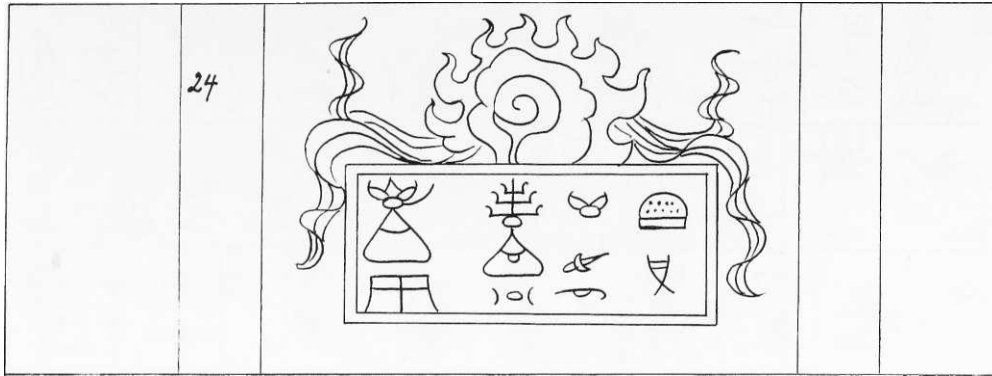

xui,9?.y - HS.OT. 521 / R. ? U 3 B. Hdr UL-UÜk'o.Muan-bpö-dz.i!-52u ssaw. Gkw-chwncj

BLATT 1st ~

ROCK-- = <m βfiT

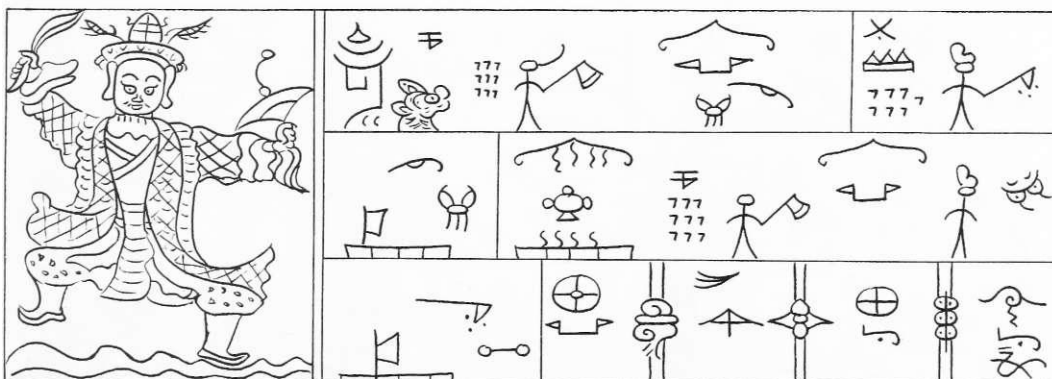
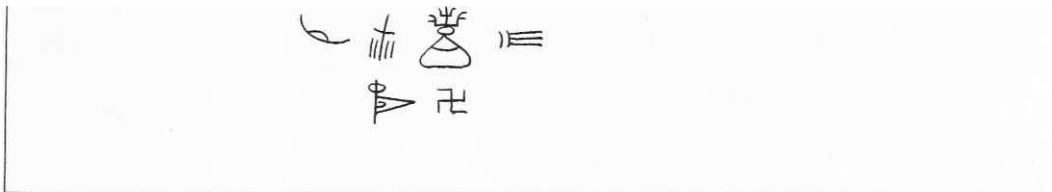

Hs.OT. 521/R. 822,3B. BLATT 2nd ~

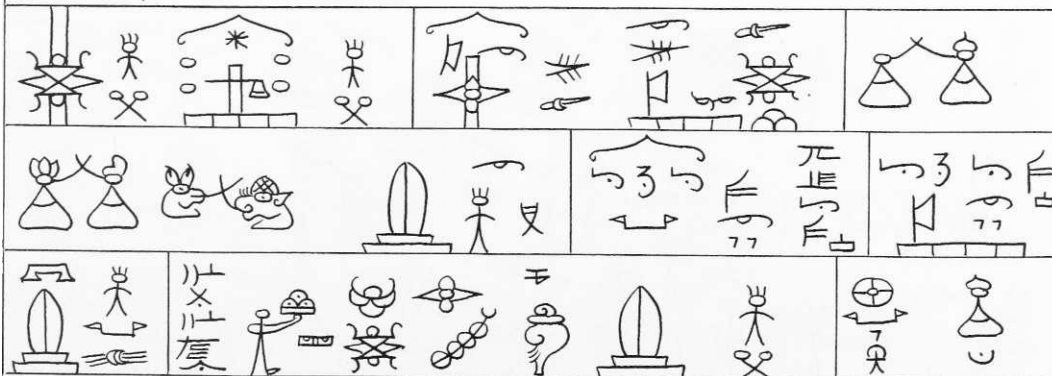

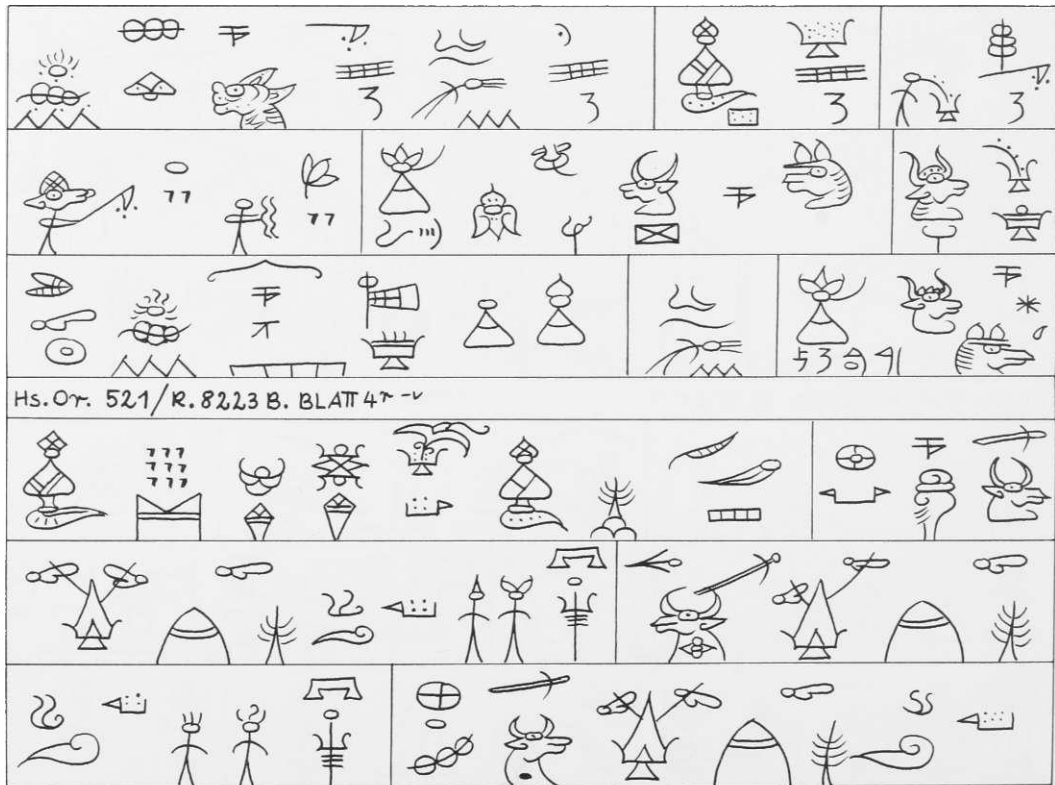
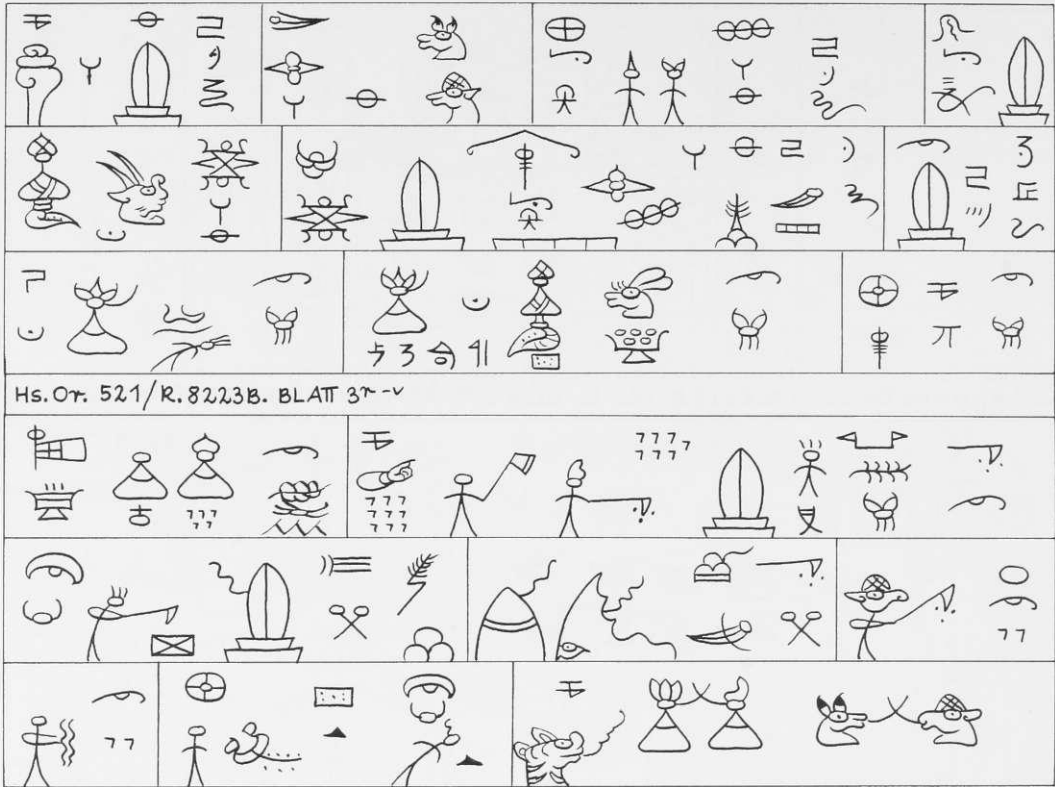

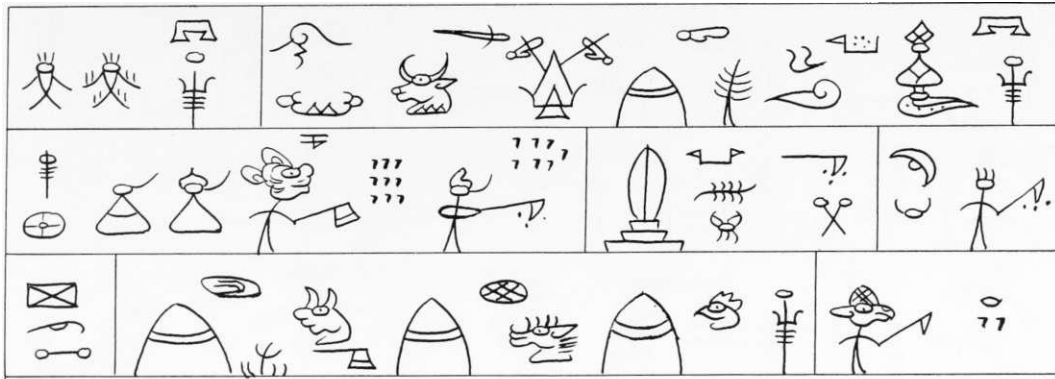

Hs. 07. 52.1/R. 82.23 B. BLATT 57-7

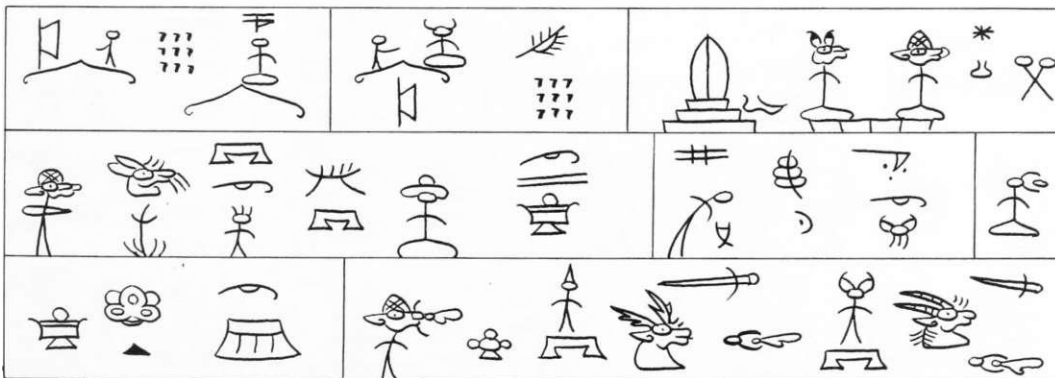
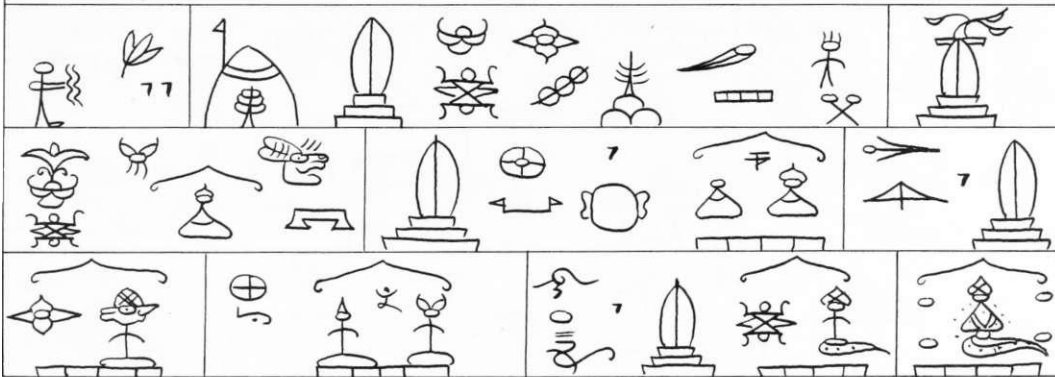

HS. 07. B. BLATT W ~

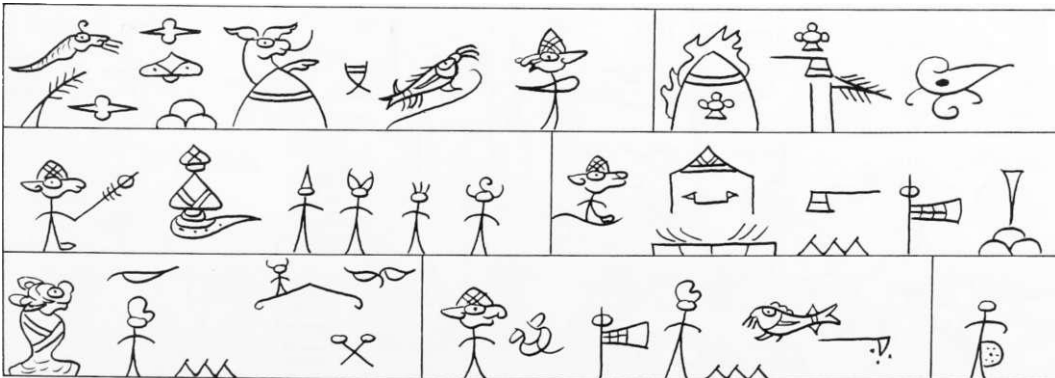

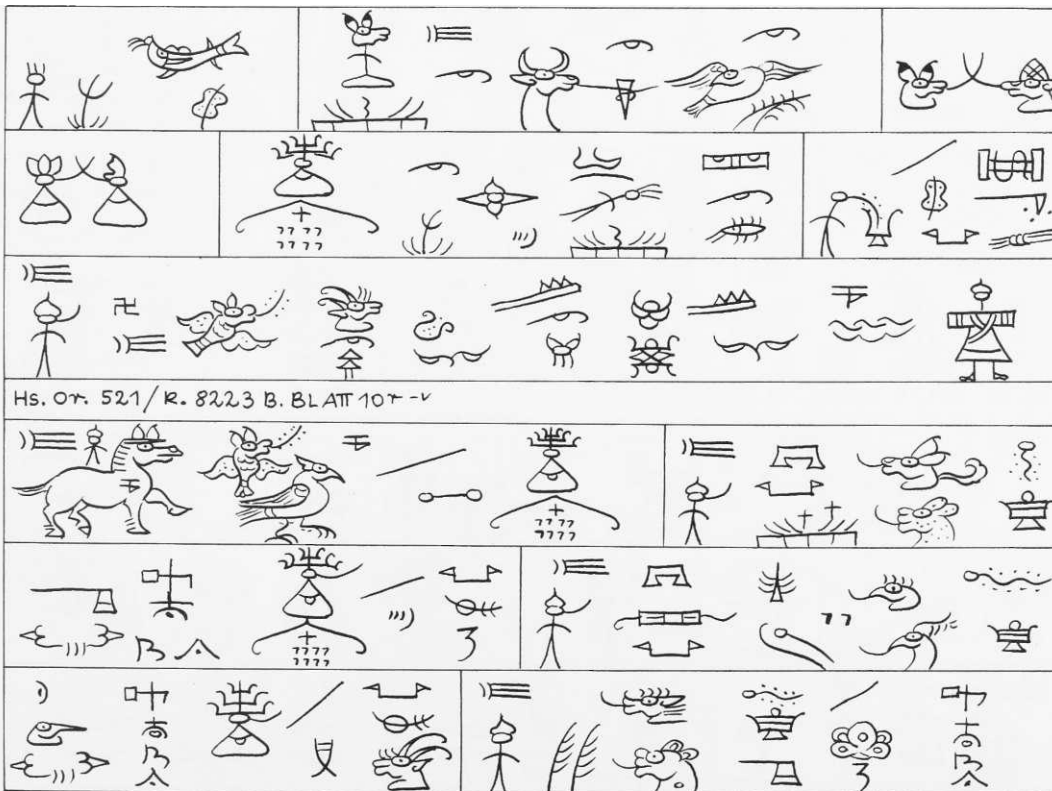
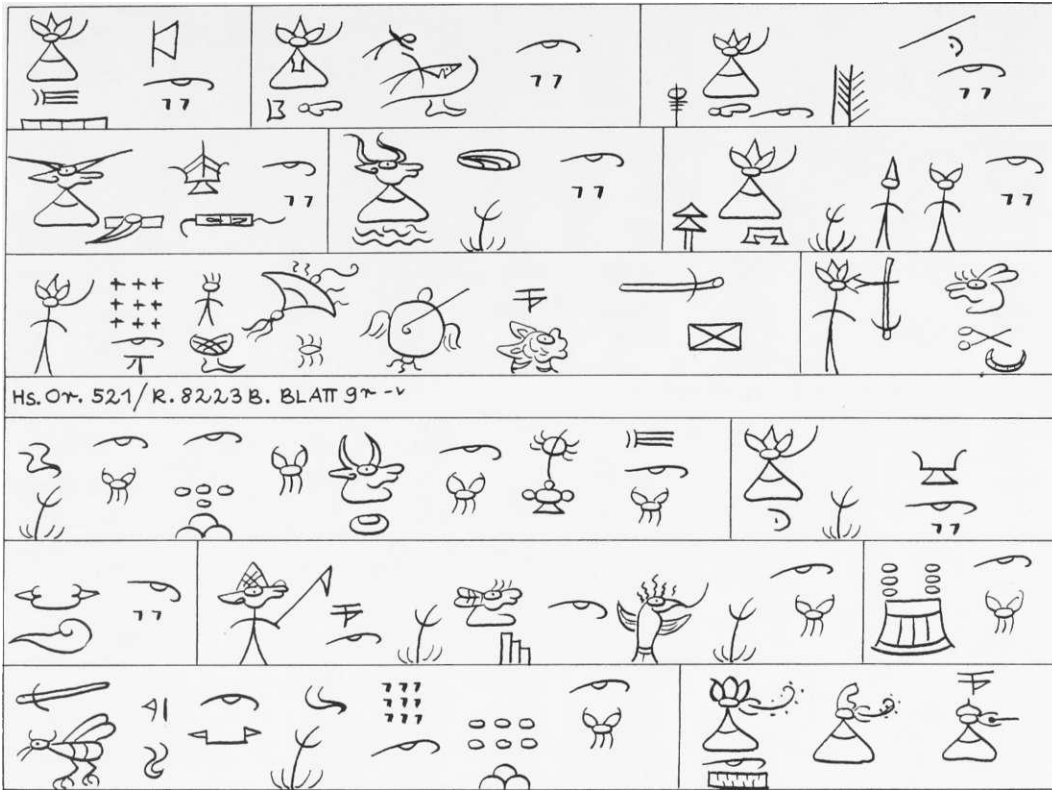

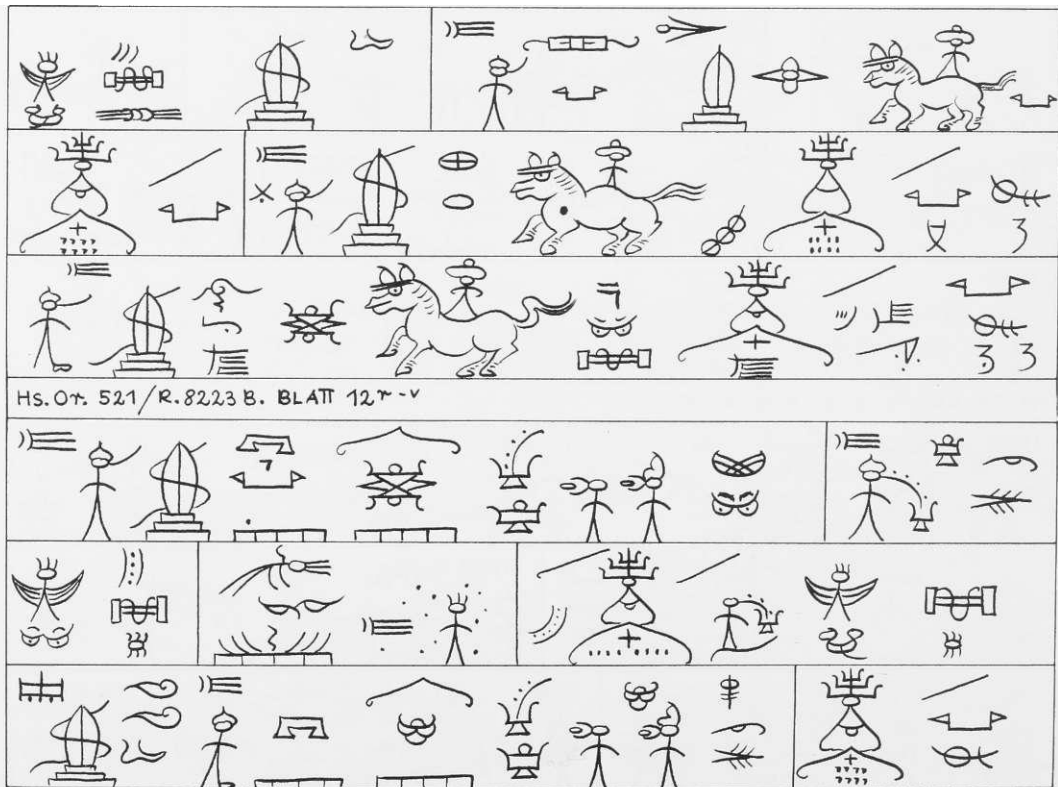
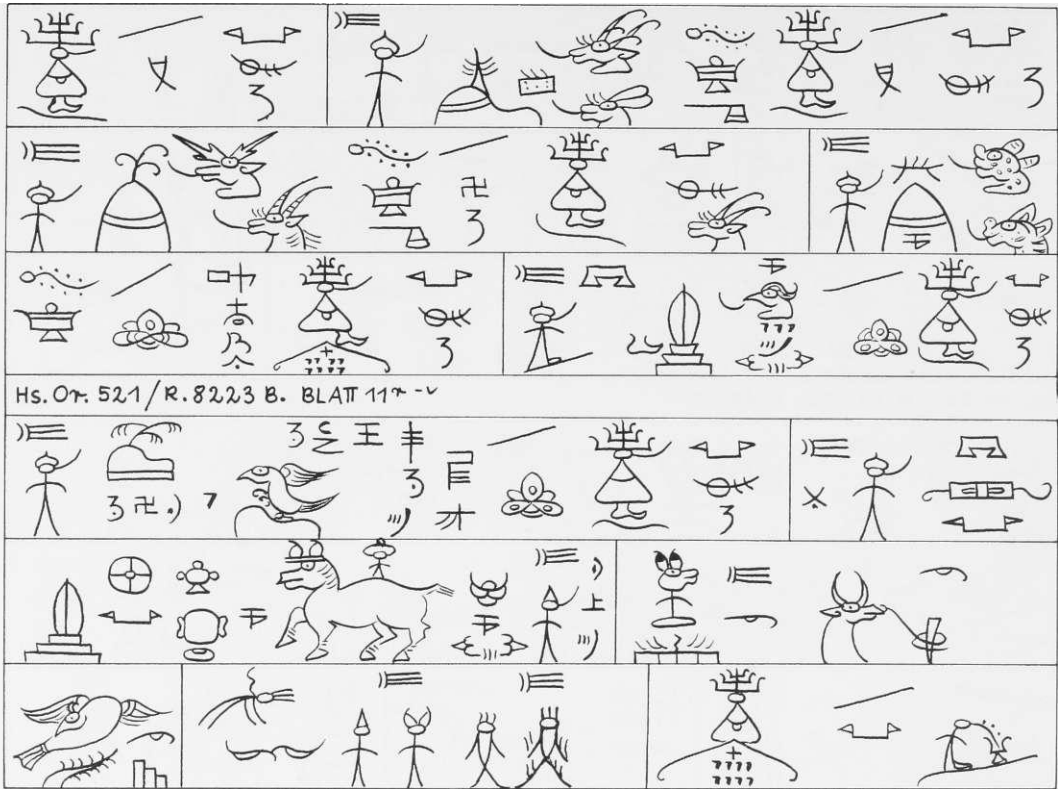

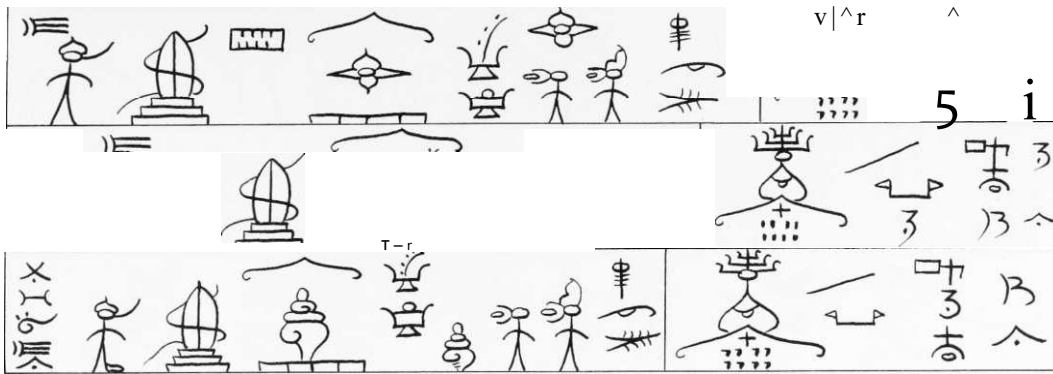

Hs.Or. 5Xl/R.ff;L2,3B. BLAT13'

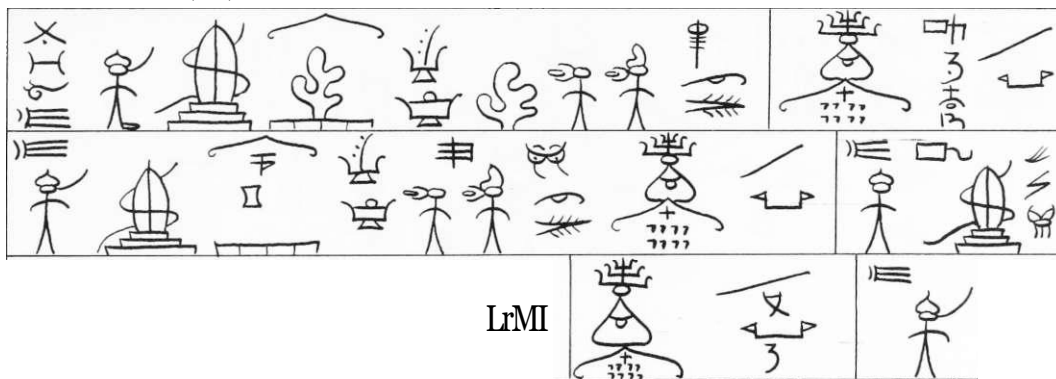

			^x 6 * 1
«q F" "Set/))SE J^S °i S 1"	4^
J _y ^ ^		T	w ü
Hs. Or. 521 / R. ^2,3B. BLAT 1 ^			
			%
' e i			N

ri		
Hs.OK- S21 /R.S2,i3B. BLATT 1S''		
$-7 \quad 1=5 \quad y$		

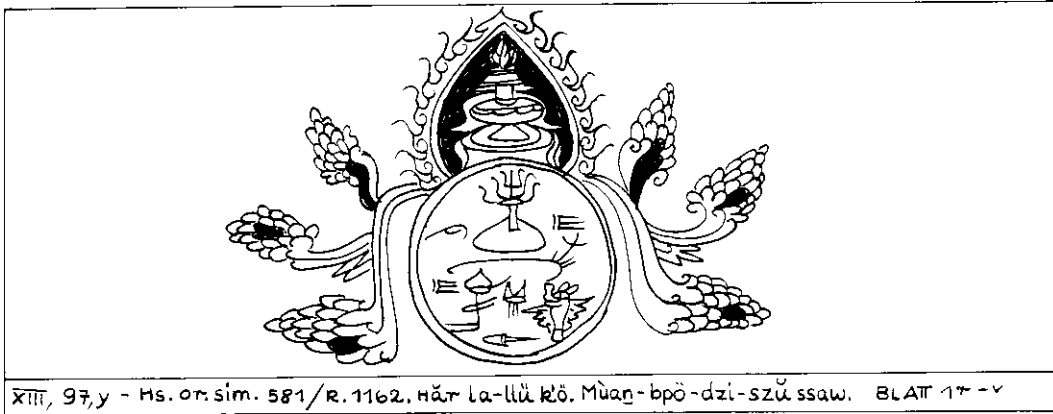

XIII, 97, y - Hs. or. sim. 581/R. 1162. Hār la-llü kō. Mūn-bpō-dzi-szū ssaw. BLATT 17-v

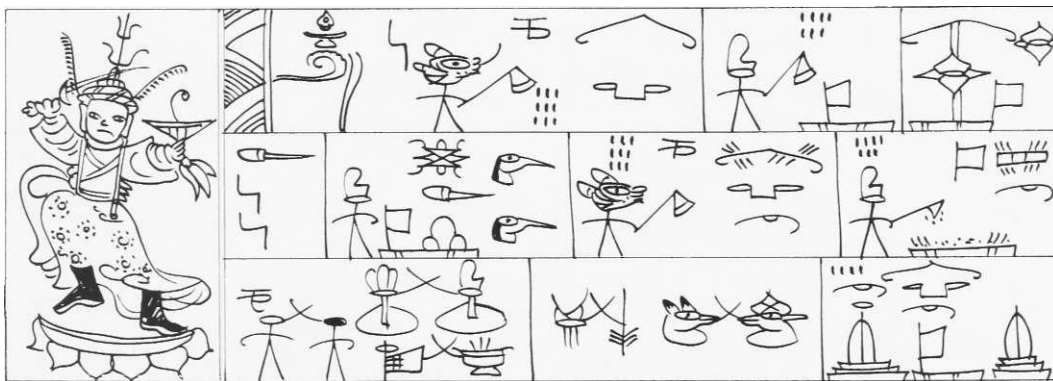
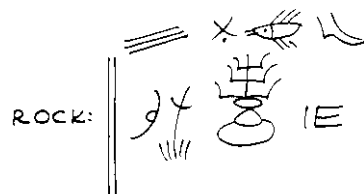

Hs. or. sim. 581/R. 1162. BLATT 27-v

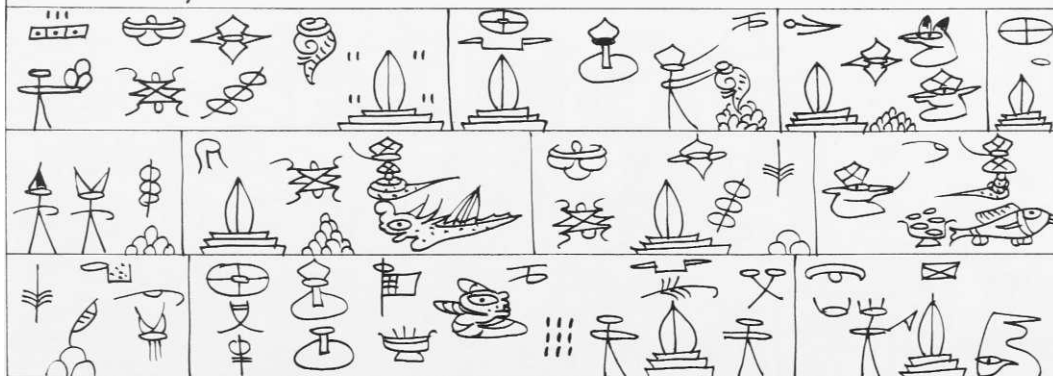

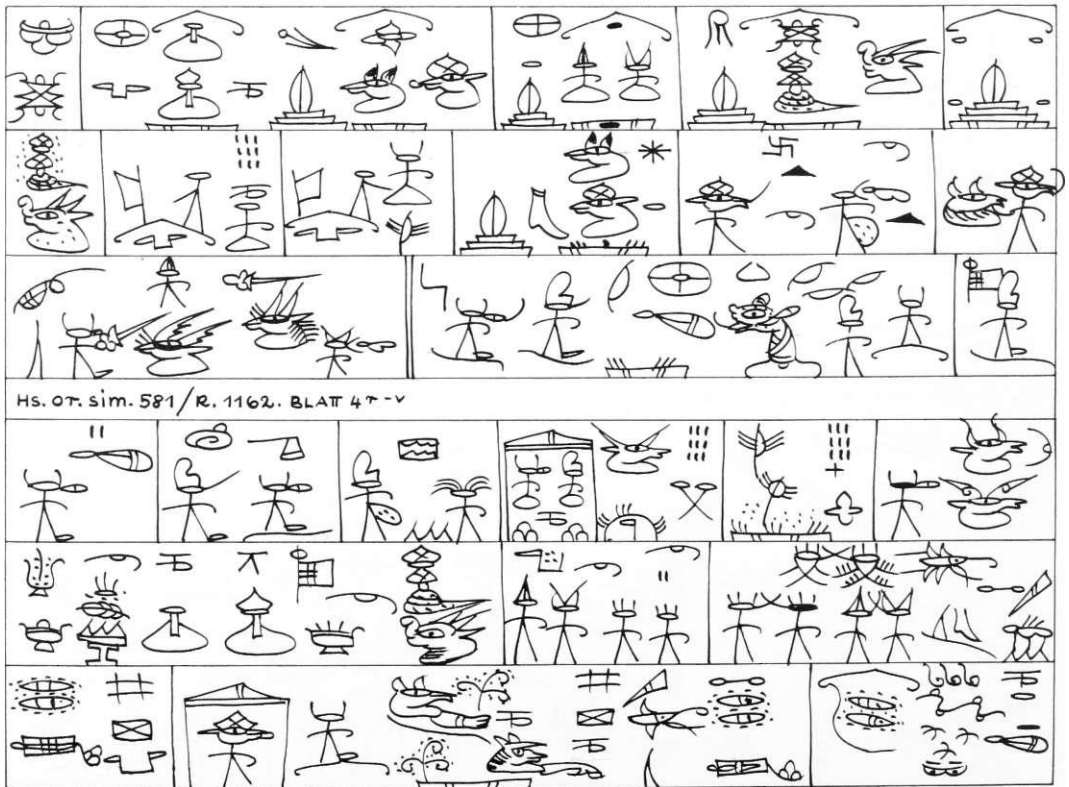
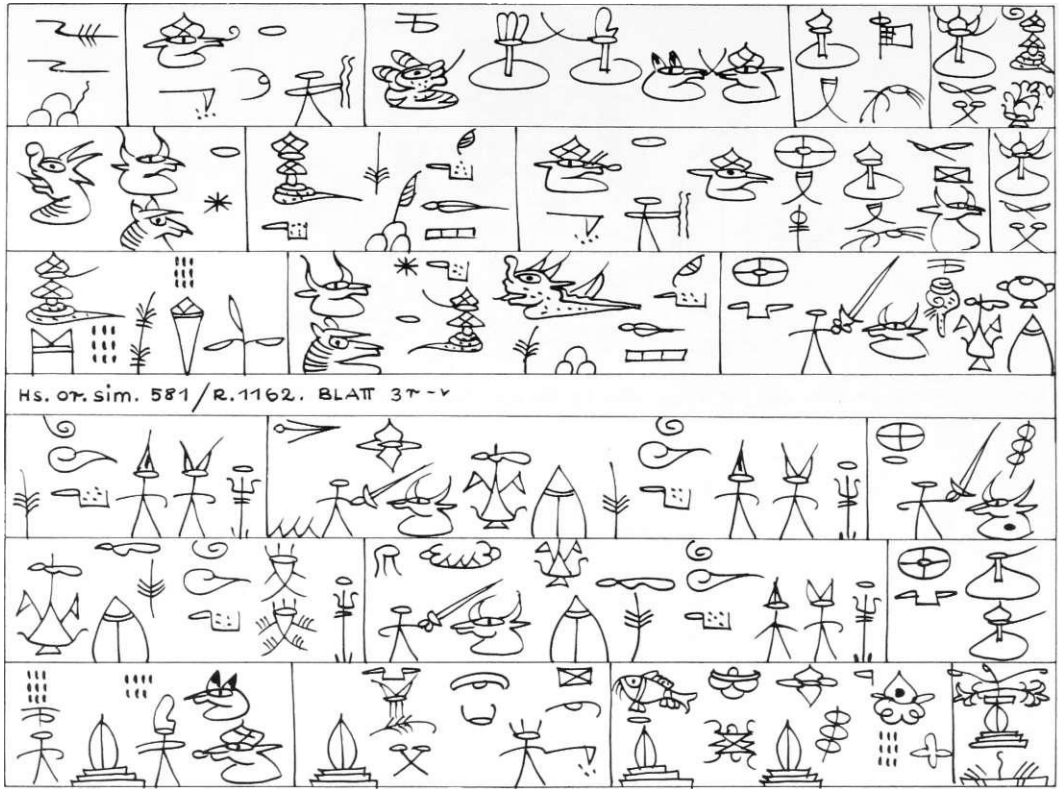

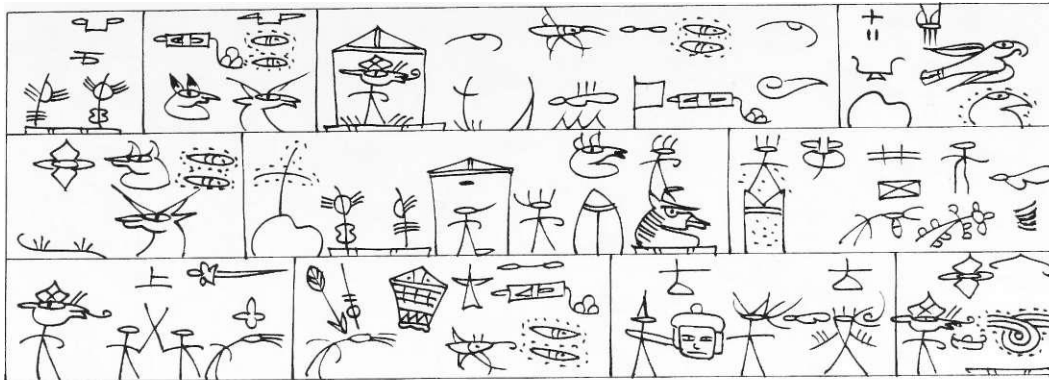

Hs. or. sim. 581/R. 1162. BLAT 57-v

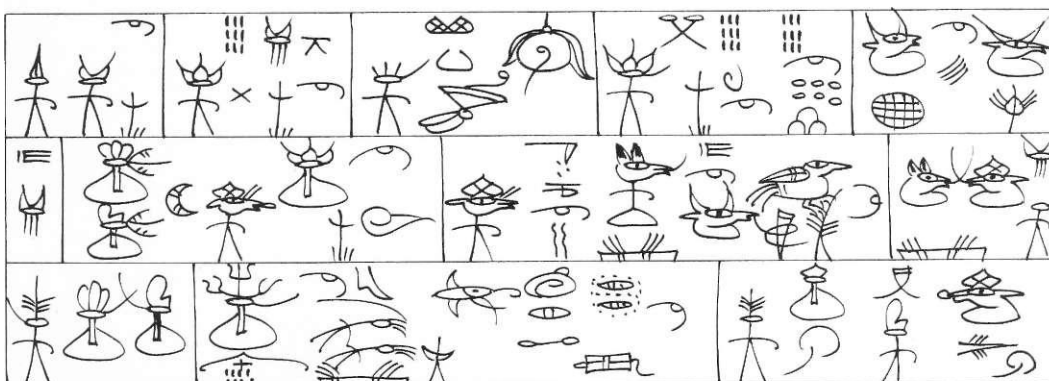
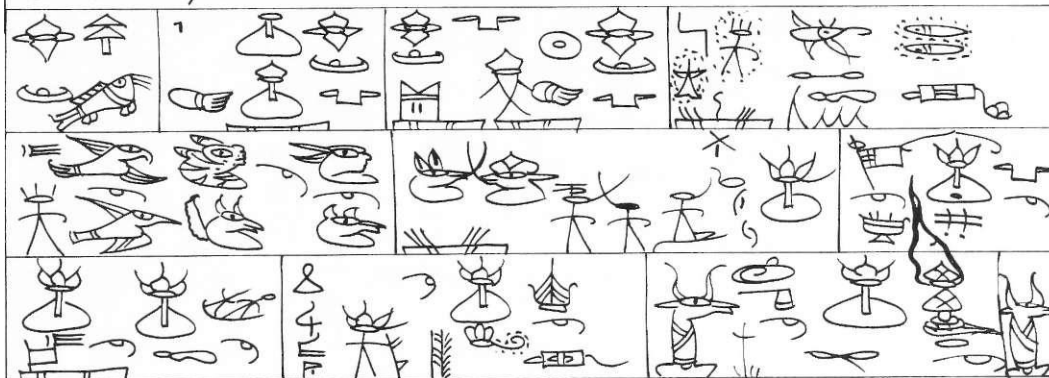

Hs. or. sim. 581/R. 1162. BLAT 67-v

